

# Robust Adaptive Control of Cooperating Mobile Manipulators With Relative Motion

Zhijun Li, *Member, IEEE*, Pey Yuen Tao, Shuzhi Sam Ge, *Fellow, IEEE*, Martin Adams, *Member, IEEE*, and Wijerupage Sardha Wijesoma, *Member, IEEE*

**Abstract**—In this paper, coupled dynamics are presented for two cooperating mobile robotic manipulators manipulating an object with relative motion in the presence of uncertainties and external disturbances. Centralized robust adaptive controls are introduced to guarantee the motion, and force trajectories of the constrained object converge to the desired manifolds with prescribed performance. The stability of the closed-loop system and the boundedness of tracking errors are proved using Lyapunov stability synthesis. The tracking of the constraint trajectory/force up to an ultimately bounded error is achieved. The proposed adaptive controls are robust against relative motion disturbances and parametric uncertainties and are validated by simulation studies.

**Index Terms**—Adaptive control, cooperation, force/motion, mobile manipulators.

## NOMENCLATURE

$O_c$	Contact point between the end effector of mobile manipulator I and the object.
$O_h$	Point where the end effector of mobile manipulator II holds the object.
$O_o$	Mass center of the object.
$O_cX_cY_cZ_c$	Frame fixed with the tool of mobile manipulator I with its origin at the contact point $O_c$ .
$O_hX_hY_hZ_h$	Frame fixed with the end effector of mobile manipulator II with its origin at point $O_h$ .
$O_oX_oY_oZ_o$	Frame fixed with the object with its origin at the mass center $O_o$ .
$OXYZ$	World coordinates.
$r_c$	Vector describing the posture of frame $O_cX_cY_cZ_c$ with $r_c = [x_c^T, \theta_c^T]^T \in \mathbb{R}^6$ .
$r_h$	Vector describing the posture of frame $O_hX_hY_hZ_h$ with $r_h = [x_h^T, \theta_h^T]^T \in \mathbb{R}^6$ .

$r_o$	Vector describing the posture of frame $O_oX_oY_oZ_o$ with $r_o = [x_o^T, \theta_o^T]^T \in \mathbb{R}^6$ .
$r_{co}$	Vector describing the posture of frame $O_cX_cY_cZ_c$ expressed in $O_oX_oY_oZ_o$ with $r_{co} = [x_{co}^T, \theta_{co}^T]^T \in \mathbb{R}^6$ .
$r_{ho}$	Vector describing the posture of frame $O_hX_hY_hZ_h$ expressed in $O_oX_oY_oZ_o$ with $r_{ho} = [x_{ho}^T, \theta_{ho}^T]^T \in \mathbb{R}^6$ .
$q_1$	Vector of joint variables of mobile manipulator I.
$q_2$	Vector of joint variables of mobile manipulator II.
$n_1$	Degrees of freedom of mobile manipulator I.
$n_2$	Degrees of freedom of mobile manipulator II.
$x_c$	Position vector of $O_c$ , the origin of frame $O_cX_cY_cZ_c$ .
$x_h$	Position vector of $O_h$ , the origin of frame $O_hX_hY_hZ_h$ .
$x_o$	Position vector of $O_o$ , the origin of frame $O_oX_oY_oZ_o$ .
$x_{co}$	Position vector of $O_c$ , the origin of frame $O_cX_cY_cZ_c$ expressed in $O_oX_oY_oZ_o$ .
$x_{ho}$	Position vector of $O_h$ , the origin of frame $O_hX_hY_hZ_h$ expressed in $O_oX_oY_oZ_o$ .
$\theta_c$	Orientation vector of frame $O_cX_cY_cZ_c$ .
$\theta_h$	Orientation vector of frame $O_hX_hY_hZ_h$ .
$\theta_o$	Orientation vector of frame $O_oX_oY_oZ_o$ .
$\theta_{co}$	Orientation vector of frame $O_cX_cY_cZ_c$ expressed in $O_oX_oY_oZ_o$ .
$\theta_{ho}$	Orientation vector of frame $O_hX_hY_hZ_h$ expressed in $O_oX_oY_oZ_o$ .

Manuscript received December 26, 2006; revised July 5, 2007, October 11, 2007, and October 31, 2007. First published December 2, 2008; current version published January 15, 2009. This work was supported in part by Singapore A\*STAR SERC TSRP Grant 052-116-0078. This paper was recommended by Associate Editor F. L. Lewis.

Z. Li was with the Department of Electrical and Computer Engineering, National University of Singapore, Singapore 117576. He is now with the Department of Automation, Shanghai Jiao Tong University, Shanghai 200240, China (e-mail: zjli@sjtu.edu.cn).

P. Y. Tao and S. S. Ge are with the Social Robotics Laboratory, Interactive Digital Media Institute, and the Department of Electrical and Computer Engineering, National University of Singapore, Singapore 117576 (e-mail: samge@nus.edu.sg).

M. Adams and W. S. Wijesoma are with the School of Electrical and Electronic Engineering, Nanyang Technological University, Singapore 639798 (e-mail: eadams@ntu.edu.sg; eswwijesoma@ntu.edu.sg).

Color versions of one or more of the figures in this paper are available online at <http://ieeexplore.ieee.org>.

Digital Object Identifier 10.1109/TSMCB.2008.2002853

## I. INTRODUCTION

MOBILE manipulators refer to robotic manipulators mounted on mobile platforms. Such systems are suitable for missions which require both locomotion and manipulation, combining the advantages of mobile platforms and robotic arms while reducing their limitations. Coordinated controls of multiple mobile manipulators have attracted the attention of many researchers [1]–[3], [5], [6]. Interest in such systems stems from the greater capability of the mobile manipulators in carrying out more complicated and dexterous tasks which cannot be accomplished by a single mobile manipulator. The applications range from transporting or assembling materials in modern factories, missions in hazardous environments, to the manipulation of undersea/space vehicles.

The control of multiple mobile manipulators presents a significant increase in complexity over the single mobile manipulator case. The difficulties lie in the fact that when multiple mobile manipulators coordinate with each other, they form a closed kinematic chain mechanism. This will impose a set of kinematic and dynamic constraints on the position and velocity of coordinated mobile manipulators. As a result, the degrees of freedom of the whole system decrease, and internal forces are generated which need to be controlled.

Thus far, the following are the two main categories of coordination schemes for multiple mobile manipulators in the literature: 1) hybrid position–force control by decentralized/centralized scheme, where the position of the object is controlled in a certain direction of the workspace, and the internal force of the object is controlled in a small range of the origin [1], [4], [5], and 2) leader–follower control for mobile manipulator, where one or a group of mobile manipulators or robotic manipulators play the role of the leader, which track a preplanned trajectory, and the rest of the mobile manipulators form the follower group which move in conjunction with the leader mobile manipulators [2], [7], [8].

However, in the hybrid position–force control of constrained coordinated multiple mobile manipulators, such as in [1], [4], and [5], although the constraint object is moving, it is usually assumed, for the ease of analysis, to be held tightly and thus has no relative motion with respect to the end effectors of the mobile manipulators. These works have focused on dynamics based on predefined fixed constraints among them. The assumption of these works is not applicable to some applications which require both the motion of the object and its relative motion with respect to the end effectors of the manipulators, such as sweeping tasks and cooperating assembly tasks by two or multiple mobile manipulators. The motion of the object with respect to the mobile manipulators can also be utilized to cope with the limited operational space and to increase task efficiency. Such tasks need the simultaneous control of position and force in the given direction, so impedance control, like in [2], [7], and [8], may not be applicable.

In [20], possible kinds of coordinated relative motions for the industrial robotic systems were listed, including arc welding systems for complex contours, paint spraying of moving workpieces, belt picking, and palletizing. In [19], a robotic system for arc welding was presented, where the coordinated relative movements are defined between the robot and the positioner for considerable efficiency at the robot station. In [21], the coordination of a part-positioning table and a manipulator for welding purpose was presented. The part-positioning table manipulates the part into a position and orientation under the given task constraints, and the manipulator produces the desired touch motion to complete the welding. Through this relative motion coordination, the welding velocity and the efficiency of the task can be significantly improved.

There is demand for robotic assembly and disassembly operations in space or subsea robotic applications, where the operations have to be carried out without special equipment due to the unstructured and/or uncertain environment [11]. Assembly and disassembly operations are decomposed into the following two types of tasks: independent and cooperative

tasks. For the independent tasks, we consider the control of the absolute position and orientation of the robots, while for the cooperative tasks, we consider the control of the relative position, orientation, and contact force between the end effectors. In this case, two robots can be used for assembling the objects in space, with each object being held by one robot [11]. It is necessary to develop a certain form of hybrid control scheme in order to control the relative motion/force between the objects and thus to carry out the task in good condition. The task of mating two subassemblies is a general example of a cooperative task that also requires the control of the relative motion/force of the end effectors.

In this paper, we consider tasks for multiple mobile manipulators in which the following conditions may hold: 1) the robots are kinematically constrained, and 2) the robots are not physically connected but work on a common object in completing a task, with both robots being in motion simultaneously. Conventional centralized and decentralized coordination schemes have not addressed coordination tasks adequately, although the leader/follower scheme may be a solution. Another motivation for developing a coordination scheme is to incorporate hybrid position and force control architecture with leader–follower coordination for easy and efficient implementation.

It should be noted that the success of the schemes [1]–[3], [5] for coordinated controls of multiple mobile manipulators relies on one's knowledge of the complex dynamics of the robotic system. Parametric uncertainties in the dynamic model, such as the payload, may lead to degraded performance and compromise the stability of the system. Recently, some works have successfully incorporated adaptive controls to deal with dynamics uncertainty of single mobile manipulator or robotic manipulators [17]. In [9], adaptive neural network based had been proposed for the motion control of a mobile manipulator. Adaptive control was proposed for the trajectory control of mobile manipulators subjected to nonholonomic constraints with unknown inertia parameters [10], which ensures the state of the system to asymptotically converge to the desired trajectory.

In this paper, we shall investigate situations where one mobile robotic manipulator (referred to as mobile manipulator I) performs the constrained motion on the surface of an object which is held tightly by another mobile robotic manipulator (referred to as manipulator II) [12]. Mobile manipulator II has to be controlled in such a manner that the constraint object follows the planned motion trajectory, while mobile manipulator I has to be controlled such that its end effector follows a planned trajectory on the surface with the desired contact force. We first present the dynamics of two mobile robotic manipulators manipulating an object with relative motion. This will be followed by centralized robust adaptive control to guarantee the convergence of the motion/force trajectories of the constraint object under parameter uncertainties and external disturbances.

The main contributions of this paper are listed as follows.

- 1) Coupled dynamics are presented for two cooperating mobile robotic manipulators manipulating an object with relative motion in the presence of the uncertainty of system dynamic parameters and external disturbances.

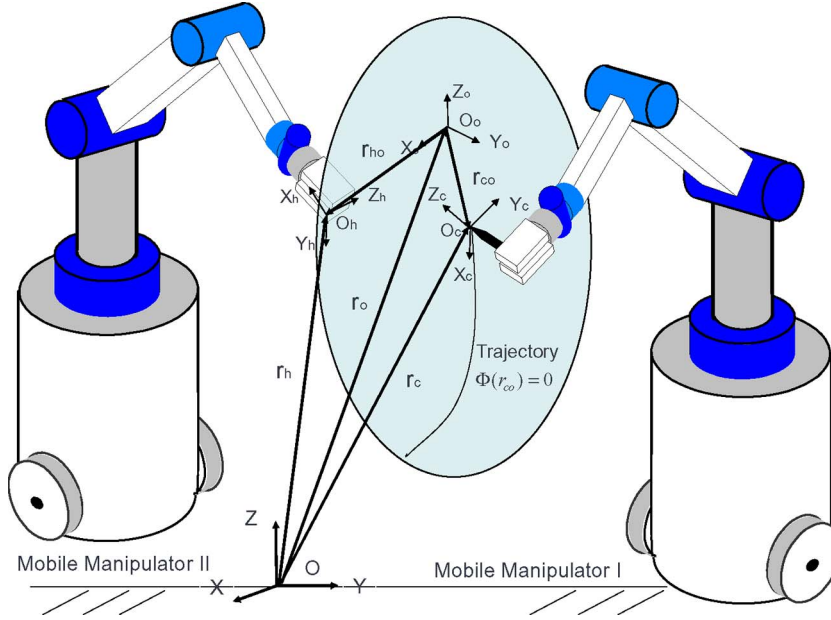

Fig. 1. Coordinated operation of two robots.

- 2) Centralized robust adaptive control, which is capable of achieving the convergence of the trajectory tracking error to an ultimately bounded error without knowing the dynamic parameters of the robots, is proposed for multiple mobile manipulators' cooperation.
- 3) Nonregressor-based control design is developed and carried out without imposing any restriction on the system dynamics.

## II. DESCRIPTION OF THE INTERCONNECTED SYSTEM

The system under study is schematically shown in Fig. 1. The object is held tightly by the end effector of mobile manipulator II and can be moved as required in space. The end effector of mobile manipulator I follows a trajectory on the surface of the object and, at the same time, exerts a certain desired force on the object.

*Assumption 2.1:* The surface of the object where the end effector of mobile arm I move on is geometrically known.

### A. Kinematic Constraints of the System

The closed kinematic relationships of the system are given by the following [12]:

$$x_c = x_o + R_o(\theta_o)x_{co} \quad (1)$$

$$x_h = x_o + R_o(\theta_o)x_{ho} \quad (2)$$

$$R_c = R_o(\theta_o)R_{co}(\theta_{co}) \quad (3)$$

$$R_h = R_o(\theta_o) \quad (4)$$

where  $R_o(\theta_o) \in \mathbb{R}^{3 \times 3}$  and  $R_{co}(\theta_{co}) \in \mathbb{R}^{3 \times 3}$  are the rotation matrices of  $\theta_o$  and  $\theta_{co}$ , respectively, and  $R_c \in \mathbb{R}^{3 \times 3}$  and  $R_h \in \mathbb{R}^{3 \times 3}$  given earlier are the rotation matrices of frames  $O_c X_c Y_c Z_c$  and  $O_h X_h Y_h Z_h$  with respect to the world coordinate, respectively. Differentiating the aforementioned equations

with respect to time  $t$  and considering that the object is tightly held by manipulator II (accordingly,  $\dot{x}_{ho} = 0$  and  $\omega_{ho} = 0$ ), we have

$$\dot{x}_c = \dot{x}_o + R_o(\theta_o)\dot{x}_{co} - S(R_o(\theta_o)x_{co})\omega_o \quad (5)$$

$$\dot{x}_h = \dot{x}_o - S(R_o(\theta_o)x_{ho})\omega_o \quad (6)$$

$$\omega_c = \omega_o + R_o(\theta_o)\omega_{co} \quad (7)$$

$$\omega_h = \omega_o \quad (8)$$

with

$$S(u) := \begin{bmatrix} 0 & -u_3 & u_2 \\ u_3 & 0 & -u_1 \\ -u_2 & u_1 & 0 \end{bmatrix}$$

for a given vector  $u = [u_1, u_2, u_3]^T$ . Define  $v_c = [\dot{x}_c^T, \omega_c^T]^T$ ,  $v_h = [\dot{x}_h^T, \omega_h^T]^T$ ,  $v_o = [\dot{x}_o^T, \omega_o^T]^T$ ,  $v_{co} = [\dot{x}_{co}^T, \omega_{co}^T]^T$ , and  $v_{ho} = [\dot{x}_{ho}^T, \omega_{ho}^T]^T$ . From (1)–(4) and (5)–(8), we have the following relationships:

$$v_c = P v_o + R_A v_{co} \quad (9)$$

$$v_h = Q v_o \quad (10)$$

where

$$R_A = \begin{bmatrix} R_o(\theta_o) & 0 \\ 0 & R_o(\theta_o) \end{bmatrix} \quad (11)$$

$$P = \begin{bmatrix} I^{3 \times 3} & -S(R_o(\theta_o)x_{co}) \\ 0 & I^{3 \times 3} \end{bmatrix} \quad (12)$$

$$Q = \begin{bmatrix} I^{3 \times 3} & -S(R_o(\theta_o)x_{ho}) \\ 0 & I^{3 \times 3} \end{bmatrix}. \quad (13)$$

Since  $R_o(\theta_o)$  is a rotation matrix,  $R_o(\theta_o)R_o^T(\theta_o) = I^{3 \times 3}$  and  $R_A R_A^T = I^{6 \times 6}$ . It is obvious that  $P$  and  $Q$  are of full rank.

From Assumption 2.1, suppose that the end effector of mobile manipulator I follows the trajectory  $\Phi(r_{co}) = 0$  in the object coordinates. The contact force  $f_c$  is given by

$$f_c = R_A J_c^T \lambda_c \quad (14)$$

$$J_c = \frac{\partial \Phi / \partial r_{co}}{\|\partial \Phi / \partial r_{co}\|} \quad (15)$$

where  $\lambda_c$  is a Lagrange multiplier related to the magnitude of the contact force. The resulting force  $f_o$  due to  $f_c$  is thus derived as follows:

$$f_o = -P^T R_A J_c^T \lambda_c. \quad (16)$$

### B. Robot Dynamics

Consider two cooperating  $n$ -DOF mobile manipulators with nonholonomic mobile platforms, as shown in Fig. 1. Combining (14) and (16), the dynamics of the constrained mobile manipulators can be described as

$$M_1(q_1)\ddot{q}_1 + C_1(q_1, \dot{q}_1)\dot{q}_1 + G_1(q_1) + d_1(t) = B_1\tau_1 + J_1^T \lambda_1 \quad (17)$$

$$M_2(q_2)\ddot{q}_2 + C_2(q_2, \dot{q}_2)\dot{q}_2 + G_2(q_2) + d_2(t) = B_2\tau_2 + J_2^T \lambda_2 \quad (18)$$

where

$$\begin{aligned} M_i(q_i) &= \begin{bmatrix} M_{ib} & M_{iva} \\ M_{iab} & M_{ia} \end{bmatrix} \\ C_i(q_i, \dot{q}_i) &= \begin{bmatrix} C_{ib} & C_{iba} \\ C_{iab} & C_{ia} \end{bmatrix} \\ G_i(q_i) &= \begin{bmatrix} G_{ib} \\ G_{ia} \end{bmatrix} \\ d_i(t) &= \begin{bmatrix} d_{ib}(t) \\ d_{ia}(t) \end{bmatrix} \\ J_1^T(q_1) &= \begin{bmatrix} A_1^T & J_{1b}^T \\ 0 & J_{1a}^T \end{bmatrix} \begin{bmatrix} I & 0 \\ 0 & R_A J_c^T \end{bmatrix} \\ J_2^T(q_2) &= \begin{bmatrix} A_2^T & J_{2b}^T \\ 0 & -J_{2a}^T P^T \end{bmatrix} \begin{bmatrix} I & 0 \\ 0 & R_A J_c^T \end{bmatrix} \\ \lambda_1 &= \begin{bmatrix} \lambda_{1n} \\ \lambda_c \end{bmatrix} \\ \lambda_2 &= \begin{bmatrix} \lambda_{2n} \\ \lambda_c \end{bmatrix} \end{aligned}$$

for  $i = 1, 2$ .  $M_i(q_i) \in \mathbb{R}^{n_i \times n_i}$  is the symmetric bounded positive-definite inertia matrix,  $C_i(q_i, \dot{q}_i)\dot{q}_i \in \mathbb{R}^{n_i}$  denote the Centripetal and Coriolis forces,  $G_i(q_i) \in \mathbb{R}^{n_i}$  are the gravitational forces,  $\tau_i \in \mathbb{R}^{p_i}$  is the vector of control inputs,  $B_i \in \mathbb{R}^{n_i \times p_i}$  is a full-rank input transformation matrix and is assumed to be known because it is a function of the fixed geometry of the system,  $d_i(t) \in \mathbb{R}^{n_i}$  is the disturbance vector,  $q_i = [q_{ib}^T, q_{ia}^T]^T \in \mathbb{R}^{n_i}$  and  $q_{ib} \in \mathbb{R}^{n_{iv}}$  describe the generalized

coordinates for the mobile platform,  $q_{ia} \in \mathbb{R}^{n_{ia}}$  are the coordinates of the manipulator, and  $n_i = n_{iv} + n_{ia}$ ;  $F_i = J_i^T \lambda_i \in \mathbb{R}^{n_i}$  denotes the vector of constraint forces; the  $n_{iv} - m$  nonintegrable and independent velocity constraints can be expressed as  $A_i \dot{q}_{ib} = 0$ ;  $\lambda_i = [\lambda_{in}^T, \lambda_c^T]^T \in \mathbb{R}^{p_i}$ , with  $\lambda_{in}$  being the Lagrangian multipliers with the nonholonomic constraints.

*Assumption 2.2:* There is sufficient friction between the wheels of the mobile platforms and the surface such that the wheels do not slip.

Under Assumption 2.2, we have  $A_i \dot{q}_{ib} = 0$ , with  $A_i(q_{ib}) \in \mathbb{R}^{(n_{iv}-m) \times n_{iv}}$ , and it is always possible to find an  $m$ -rank matrix  $H_i(q_{ib}) \in \mathbb{R}^{n_{iv} \times m}$  formed by a set of smooth and linearly independent vector fields spanning the null space of  $A_i$ , i.e.,

$$H_i^T(q_{ib})A_i^T(q_{ib}) = 0_{m \times (n_{iv}-m)}. \quad (19)$$

Since  $H_i = [h_{i1}(q_{ib}), \dots, h_{im}(q_{ib})]$  is formed by a set of smooth and linearly independent vector fields spanning the null space of  $A_i(q_{ib})$ , define an auxiliary time function  $v_{ib} = [v_{ib1}, \dots, v_{ibm}]^T \in \mathbb{R}^m$  such that

$$\dot{q}_{ib} = H_i(q_{ib})v_{ib} = h_{i1}(q_{ib})v_{ib1} + \dots + h_{im}(q_{ib})v_{ibm} \quad (20)$$

which is the so-called kinematics of nonholonomic system. Let  $v_{ia} = \dot{q}_{ia}$ . One can obtain

$$\dot{q}_i = R_i(q_i)v_i \quad (21)$$

where  $v_i = [v_{ib}^T, v_{ia}^T]^T$  and  $R_i(q_i) = \text{diag}[H_i(q_{ib}), I_{n_{ia} \times n_{ia}}]$ .

Differentiating (21) yields

$$\ddot{q}_i = \dot{R}_i(q_i)v_i + R_i(q_i)\dot{v}_i. \quad (22)$$

Substituting (22) into (17) and (18) and multiplying both sides with  $R_i^T(q_i)$  to eliminate  $\lambda_{in}$  yield

$$\begin{aligned} M_{i1}(q_i)\dot{v}_i + C_{i1}(q_i, \dot{q}_i)v_i + G_{i1}(q_i) + d_{i1}(t) \\ = B_{i1}(q_i)\tau + J_{i1}^T \lambda_i \end{aligned} \quad (23)$$

where  $M_{i1}(q_i) = R_i(q_i)^T M_i(q_i) R_i(q_i)$ ,  $C_{i1}(q_i, \dot{q}_i) = R_i^T(q_i) M_i(q_i) \dot{R}_i(q_i) + R_i^T(q_i) C_i(q_i, \dot{q}_i) R_i(q_i)$ ,  $G_{i1}(q_i) = R_i^T(q_i) G_i(q_i)$ ,  $d_{i1}(t) = R_i^T(q_i) d_i(t)$ ,  $B_{i1} = R_i^T(q_i) B_i(q_i)$ ,  $J_{i1}^T = R_i^T(q_i) J_i^T$ , and  $\lambda_i = \lambda_c$ .

*Assumption 2.3:* There exists some diffeomorphic state transformation  $T_2(q)$  for the class of nonholonomic systems considered in this paper such that the kinematic nonholonomic subsystem (21) can be globally transformed into a chained form

$$\begin{cases} \dot{\zeta}_{ib1} = u_{i1} \\ \dot{\zeta}_{ibj} = u_{i1} \zeta_{ib(j+1)} \quad (2 \leq j \leq n_v - 1) \\ \dot{\zeta}_{ibn_v} = u_{i2} \\ \dot{\zeta}_{ia} = \dot{q}_{ia} = u_{ia} \end{cases} \quad (24)$$

where

$$\zeta_i = [\zeta_{ib}^T, \zeta_{ia}^T]^T = T_1(q_i) = [T_{11}^T(q_{ib}), q_{ia}^T]^T \quad (25)$$

$$v_i = [v_{ib}^T, v_{ia}^T]^T = T_2(q_i)u_i = [(T_{21}(q_{ib})u_{ib})^T, u_{ia}^T]^T \quad (26)$$

with  $T_2(q_i) = \text{diag}[T_{21}(q_{ib}), I]$  and  $u_i = [u_{ib}^T, u_{ia}^T]^T$ , where  $u_{ia} = \dot{q}_{ia}$ .

*Remark 2.1:* This assumption is reasonable, and examples of nonholonomic system which can be globally transformed into a chained form are the differentially driven wheeled mobile robot and the unicycle wheeled mobile robot [16]. A necessary and sufficient condition was given for the existence of the transformation  $T_2(q)$  of the kinematic system (21) with a differentially driven wheeled mobile robot into this chained form (single chain) [15], [16]. For the other types of mobile platform (multichain case), the discussion on the existence condition of the transformation is given in Proposition A.1 (See Appendix A).

Consider the aforesaid transformations, the dynamic system [(17) and (18)] could be converted into the following canonical transformation, for  $i = 1, 2$ :

$$M_{i2}(\zeta_i)\dot{u}_i + C_{i2}(\zeta_i, \dot{\zeta}_i)u_i + G_{i2}(\zeta_i) + d_{i2}(t) = B_{i2}\tau_i + J_{i2}^T\lambda_i \quad (27)$$

where

$$\begin{aligned} M_{i2}(\zeta_i) &= T_2^T(q_i)M_{i1}(q)T_2(q_i)|_{q_i=T_1^{-1}(\zeta_i)} \\ C_{i2}(\zeta_i, \dot{\zeta}_i) &= T_2^T(q_i)[M_{i1}(q_i)\dot{T}_2(q_i) \\ &\quad + C_{i1}(q_i, \dot{q}_i)T_2(q_i)]|_{q_i=T_1^{-1}(\zeta_i)} \\ G_{i2}(\zeta_i) &= T_2^T(q_i)G_{i1}(q_i)|_{q_i=T_1^{-1}(\zeta_i)} \\ d_{i2}(t) &= T_2^T(q_i)d_i(t)|_{q_i=T_1^{-1}(\zeta_i)} \\ B_{i2} &= T_2^T(q_i)B_{i1}(q_i)|_{q_i=T_1^{-1}(\zeta_i)} \\ J_{i2}^T &= T_2^T(q_i)J_{i1}^T|_{q=T_1^{-1}(\zeta_i)}. \end{aligned}$$

### C. Reduced Dynamics

*Assumption 2.4:* The Jacobian matrix  $J_{i2}$  is uniformly bounded and uniformly continuous if  $q_i$  is uniformly bounded and uniformly continuous.

*Assumption 2.5:* Each manipulator is redundant and operating away from any singularity.

*Remark 2.2:* Under Assumptions 2.4 and 2.5, the Jacobian  $J_{i2}$  is of full rank. The vector  $q_{ia} \in \mathbb{R}^{n_{ia}}$  can always be properly rearranged and partitioned into  $q_{ia} = [q_{ia}^{1T}, q_{ia}^{2T}]^T$ , where  $q_{ia}^1 = [q_{ia1}^1, \dots, q_{ia(n_{ia}-\kappa_i)}^1]^T$  describes the constrained motion of the manipulator and  $q_{ia}^2 \in \mathbb{R}^{\kappa_i}$  denotes the remaining joint variables which make the arm redundant such that the possible breakage of contact could be compensated.

Therefore, we have

$$J_{i2}(q_i) = [J_{i2b}, J_{i2a}^1, J_{i2a}^2]. \quad (28)$$

Considering the object trajectory and relative motion trajectory as holonomic constraints, we can obtain

$$\dot{q}_{ia}^2 = -(J_{i2a}^2)^{-1} [J_{i2b}u_{ib} + J_{i2a}^1\dot{q}_{ia}^1] \quad (29)$$

$$\begin{aligned} u_i &= \begin{bmatrix} u_{ib} \\ \dot{q}_{ia}^1 \\ -(J_{i2a}^2)^{-1} [J_{i2b}u_{ib} + J_{i2a}^1\dot{q}_{ia}^1] \end{bmatrix} \\ &= L_i u_i^1 \end{aligned} \quad (30)$$

where

$$L_i = \begin{bmatrix} I_{m \times m} & 0 \\ 0 & I_{(n_{ia}-\kappa_i) \times (n_{ia}-\kappa_i)} \\ -(J_{i2a}^2)^{-1} J_{i2b} & -(J_{i2a}^2)^{-1} J_{i2a}^1 \end{bmatrix} \quad (31)$$

$$u_i^1 = [u_{ib} \quad \dot{q}_{ia}^1]^T \quad (32)$$

with  $u_i^1 \in \mathbb{R}^{(n_{ia}+m-\kappa_i)}$  and  $L_i \in \mathbb{R}^{(n_{ia}+m) \times (n_{ia}+m-\kappa_i)}$ . From the definition of  $J_{i2}$  in (28) and  $L_i$  previously, we have  $L_i^T J_{i2}^T = 0$ .

Combining (27) and (30), we can obtain the following compact dynamics:

$$M\dot{u}^1 + Cu^1 + G + d = B\tau + J^T\lambda \quad (33)$$

where

$$\begin{aligned} M &= \begin{bmatrix} M_{12}L_1 & 0 \\ 0 & M_{22}L_2 \end{bmatrix} & L &= \begin{bmatrix} L_1 & 0 \\ 0 & L_2 \end{bmatrix} \\ C &= \begin{bmatrix} M_{12}\dot{L}_1 + C_{12}L_1 & 0 \\ 0 & M_{22}\dot{L}_2 + C_{22}L_2 \end{bmatrix} \\ G &= \begin{bmatrix} G_{12} \\ G_{22} \end{bmatrix} & B &= \begin{bmatrix} B_{12} & 0 \\ 0 & B_{22} \end{bmatrix} & \lambda &= \lambda_c \\ d &= \begin{bmatrix} d_{12}(t) \\ d_{22}(t) \end{bmatrix} & \tau &= \begin{bmatrix} \tau_1 \\ \tau_2 \end{bmatrix} & J^T &= \begin{bmatrix} J_{12}^T \\ J_{22}^T \end{bmatrix}. \end{aligned}$$

*Property 2.1:* Matrices  $\mathcal{M} = L^T M$  and  $\mathcal{G} = L^T G$  are uniformly bounded and uniformly continuous if  $\zeta = [\zeta_1, \zeta_2]^T$  is uniformly bounded and continuous, respectively. Matrix  $\mathcal{C} = L^T C$  is uniformly bounded and uniformly continuous if  $\dot{\zeta} = [\dot{\zeta}_1, \dot{\zeta}_2]^T$  is uniformly bounded and continuous.

*Property 2.2:*  $\forall \zeta \in \mathbb{R}^{n_1+n_2}$ ,  $0 < \lambda_{\min} I \leq \mathcal{M}(\zeta) \leq \beta I$ , where  $\lambda_{\min}$  is the minimal eigenvalue of  $\mathcal{M}$  and  $\beta > 0$ .

## III. CENTRALIZED ROBUST ADAPTIVE-CONTROL DESIGN

### A. Problem Statement and Control Diagram

Let  $r_o^d(t)$  be the desired trajectory of the object,  $r_{co}^d(t)$  be the desired trajectory on the object, and  $\lambda_c^d(t)$  be the desired constraint force. The first control objective is to drive the mobile manipulators such that  $r_o(t)$  and  $r_{co}(t)$  track their desired trajectories  $r_o^d(t)$  and  $r_{co}^d(t)$ , respectively. Accordingly, it is only necessary to make  $q$  track the desired trajectory  $q^d = [q_1^{dT}, q_2^{dT}]^T$  since  $q = [q_1^T, q_2^T]^T$  completely determines  $r_o(t)$  and  $r_{co}(t)$ . Under Assumption 2.4, with the desired joint trajectory  $q^d$ , there exists a transformation  $\dot{q}^d = R(q^d)v^d$ ,  $\zeta^d = T_1(q^d)$ , and  $u_d = T_2^{-1}(q^d)v^d$ , where  $v^d = [v_1^{dT}, v_2^{dT}]^T$ ,  $v = [v_1^T, v_2^T]^T$ ,  $\zeta^d = [\zeta_1^{dT}, \zeta_2^{dT}]^T$ ,  $\zeta = [\zeta_1^T, \zeta_2^T]^T$ ,  $u_d = [u_{1d}^T, u_{2d}^T]^T$ , and  $u = [u_1^T, u_2^T]^T$ . Therefore, the tracking problem can be treated as formulating a control strategy such that  $\zeta \rightarrow \zeta^d$  and  $u \rightarrow u_d$  as  $t \rightarrow \infty$ . The second control objective is to make  $\lambda_c(t)$  track the desired trajectory  $\lambda_c^d(t)$ . The centralized control diagram for two mobile manipulators is shown in Fig. 2.

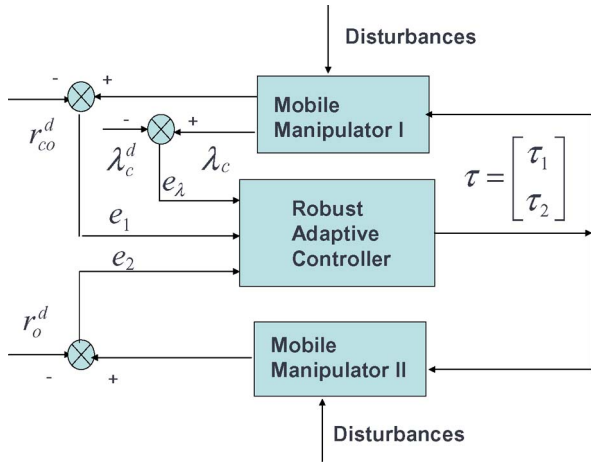

Fig. 2. Block diagram of the proposed control scheme.

**Definition 3.1:** Consider time-varying positive functions  $\delta_k$  and  $\alpha_\zeta$  which converge to zero as  $t \rightarrow \infty$  and satisfy

$$\lim_{t \rightarrow \infty} \int_0^t \delta_k(\omega) d\omega = a_k < \infty \quad (34)$$

$$\lim_{t \rightarrow \infty} \int_0^t \alpha_\zeta(\omega) d\omega = b_\zeta < \infty \quad (35)$$

with finite constants  $a_k$  and  $b_\zeta$ , where  $k = 1, \dots, 6$  and  $\zeta = 1, \dots, 5$ . There are many choices for  $\delta_k$  and  $\alpha_\zeta$  that satisfy the aforementioned condition, for example,  $\delta_k = \alpha_\zeta = 1/(1+t)^2$ .

## B. Control Design

The complete model of the coordinated nonholonomic mobile manipulators consists of the two cascaded subsystems (24) and the combined dynamic model (33). As a consequence, the

generalized velocity  $u$  cannot be used to control the system directly, as assumed in the design of controllers at the kinematic level. Instead, the desired velocities must be realized through the design of the control inputs  $\tau$ 's (33). The aforesaid properties imply that the dynamics (33) retains the mechanical system structure of the original system (18), which is fundamental for designing the robust control law. In this section, we will develop a strategy so that the subsystem (24) tracks  $\zeta^d$  through the design of a virtual control  $z$ , defined in (36) and (37) hereafter, and at the same time, the output of the mechanical subsystem (33) is controlled to track this desired signal. In turn, the tracking goal can be achieved.

For the given  $\zeta^d = [\zeta_1^{dT}, \zeta_2^{dT}]^T$ , the tracking errors are denoted as  $e = \zeta - \zeta^d = [e_1^T, e_2^T]^T$ ,  $e_i = [e_{ib}^T, e_{ia}^T]^T$ ,  $e_{ib} = [e_{i1}, e_{i2}, \dots, e_{in_v}]^T = \zeta_{ib} - \zeta_{ib}^d$ ,  $e_{ia} = \zeta_{ia} - \zeta_{ia}^d$ , and  $e_\lambda = \lambda_c - \lambda_c^d$ . Define the virtual control  $z = [z_1^T, z_2^T]^T$  and  $z_i = [z_{ib}^T, z_{ia}^T]^T$  as (36)–(39) [23], shown at the bottom of the page, and  $l = n_{iv} - 2$ ,  $u_{id1}^{(l)}$  is the  $l$ th derivative of  $u_{id1}$  with respect to  $t$ , and  $k_j$  is positive constant, and  $K_{ia}$  is diagonal positive.

Denote  $\tilde{u} = [\tilde{u}_b, \tilde{u}_a]^T = [u_b - z_b, u_a - z_a]^T$ , and define a filter tracking error

$$\sigma = \begin{bmatrix} u_b \\ \tilde{u}_a \end{bmatrix} + K_u \int_0^t \tilde{u} ds \quad (40)$$

with  $K_u = \text{diag}[0_{m \times m}, K_{u1}] > 0$ , where  $K_{u1} \in \mathbb{R}^{(n_{ia} - \kappa_i) \times (n_{ia} - \kappa_i)}$ . We could obtain  $\dot{\sigma} = \begin{bmatrix} \dot{u}_b \\ \tilde{u}_a \end{bmatrix} + K_u \tilde{u}$  and  $u = \nu + \sigma$ , with  $\nu = \begin{bmatrix} 0 \\ z_a \end{bmatrix} - K_u \int_0^t \tilde{u} ds$ .

We could rewrite (33) as

$$M\dot{\sigma} + C\sigma + M\nu + C\nu + G + d = B\tau + J^T\lambda. \quad (41)$$

If the system is certain, we could choose the control law given by

$$B\tau = M(\dot{\nu} - K_\sigma\sigma) + C(\nu + \sigma) + G + d - J^T\lambda_h \quad (42)$$

$$z_{ib} = \begin{bmatrix} u_{id1} + \eta_i \parallel u_{id2} - s_{i(n_{iv}-1)}u_{id1} - k_{n_{iv}}s_{in_{iv}} + \sum_{j=0}^{n_{iv}-3} \frac{\partial(e_{in_{iv}} - s_{in_{iv}})}{\partial u_{id1}^{(j)}} u_{id1}^{(j+1)} + \sum_{j=2}^{n_{iv}-1} \frac{\partial(e_{in_{iv}} - s_{in_{iv}})}{\partial e_{ij}} e_{i(j+1)} \end{bmatrix} \quad (36)$$

$$z_{ia} = \dot{q}_{ia}^{1d} - K_{1a}(q_{ia}^1 - q_{ia}^{1d}) \quad (37)$$

$$s_i = \begin{bmatrix} e_{i1} \\ e_{i2} \\ e_{i3} + k_2 s_{i2} u_{id1}^{2l-1} \\ e_{i4} + s_{i2} + \frac{1}{u_{id1}} \sum_{j=0}^0 \frac{\partial(e_{i3} - s_{i3})}{\partial u_{id1}^{(j)}} u_{id1}^{(j+1)} + \sum_{j=2}^2 \frac{\partial(e_{i3} - s_{i3})}{\partial e_{ij}} e_{i(j+1)} + k_3 s_{i3} u_{id1}^{2l-1} \\ \vdots \\ e_{in_{iv}} + s_{i(n_{iv}-2)} + k_{n_{iv}-1} s_{i(n_{iv}-1)} u_{id1}^{2l-1} - \frac{1}{u_{id1}} \sum_{j=0}^{n_{iv}-4} \frac{\partial(e_{i(n_{iv}-1)} - s_{i(n_{iv}-1)})}{\partial u_{id1}^{(j)}} u_{id1}^{(j+1)} - \sum_{j=2}^{n_{iv}-2} \frac{\partial(e_{i(n_{iv}-1)} - s_{i(n_{iv}-1)})}{\partial e_{ij}} e_{i(j+1)} \end{bmatrix} \quad (38)$$

$$\dot{\eta}_i = -k_0 \eta_i - k_1 s_{i1} - \sum_{j=2}^{n_{iv}-1} s_{ij} \zeta_{i(j+1)} + \sum_{k=3}^{n_{iv}} s_{ik} \sum_{j=2}^{k-1} \frac{\partial(e_{ik} - s_{ik})}{\partial e_{ik}} \zeta_{i(k+1)} \quad (39)$$

with diagonal matrix  $K_\sigma > 0$ . The force-control input  $\lambda_h$  as

$$\lambda_h = \lambda_d - K_\lambda \tilde{\lambda} - K_I \int_0^t \tilde{\lambda} dt \quad (43)$$

where  $\tilde{\lambda} = \lambda_c - \lambda_c^d$ ,  $K_\lambda$  is a constant matrix of proportional control feedback gains, and  $K_I$  is a constant matrix of integral control feedback gains.

However, since  $\mathcal{M}(\zeta)$ ,  $\mathcal{C}(\zeta, \dot{\zeta})$ , and  $\mathcal{G}(\zeta)$  are uncertain, to facilitate the control formulation, the following assumption is required.

*Assumption 3.1:* There exist some finite-positive constants  $b$ ,  $c_\zeta > 0$  ( $1 \leq \zeta \leq 4$ ), and finite-nonnegative constant  $c_5 \geq 0$  such that  $\forall \zeta \in \mathbb{R}^{2n}$ ,  $\forall \dot{\zeta} \in \mathbb{R}^{2n}$ ,  $\|\Delta M\| = \|\mathcal{M} - M_0\| \leq c_1$ ,  $\|\Delta C\| = \|\mathcal{C} - C_0\| \leq c_2 + c_3 \|\dot{\zeta}\|$ ,  $\|\Delta G\| = \|\mathcal{G} - G_0\| \leq c_4$ , and  $\sup_{t \geq 0} \|d_L(t)\| \leq c_5$ , where  $M_0$ ,  $C_0$ , and  $G_0$  are nominal parameters of the system [22], [24].

Letting  $\mathcal{B} = L^T B$ , the proposed control for the system is given as

$$\mathcal{B}\tau = U_1 + U_2 \quad (44)$$

where  $U_1$  is the nominal control

$$U_1 = M_0(\dot{\nu} - K_\sigma \sigma) + C_0(\nu + \sigma) + G_0 \quad (45)$$

and  $U_2$  is designed to compensate for the parametric errors arising from estimating the unknown functions  $\mathcal{M}$ ,  $\mathcal{C}$ , and  $\mathcal{G}$  and the disturbance, respectively

$$U_2 = U_{21} + U_{22} + U_{23} + U_{24} + U_{25} + U_{26} \quad (46)$$

$$U_{21} = -\frac{\beta}{\lambda_{\min}} \frac{\hat{c}_1^2 \|K_\sigma \sigma - \dot{\nu}\|^2 \sigma}{\hat{c}_1 \|K_\sigma \sigma - \dot{\nu}\| \|\sigma\| + \delta_1} \quad (47)$$

$$U_{22} = -\frac{\beta}{\lambda_{\min}} \frac{\hat{c}_2^2 \|\sigma + \nu\|^2 \sigma}{\hat{c}_2 \|\sigma + \nu\| \|\sigma\| + \delta_2} \quad (48)$$

$$U_{23} = -\frac{\beta}{\lambda_{\min}} \frac{\hat{c}_3^2 \|\dot{\zeta}\|^2 \|\sigma + \nu\|^2 \sigma}{\hat{c}_3 \|\dot{\zeta}\| \|\sigma + \nu\| \|\sigma\| + \delta_3} \quad (49)$$

$$U_{24} = -\frac{\beta}{\lambda_{\min}} \frac{\hat{c}_4^2 \sigma}{\hat{c}_4 \|\sigma\| + \delta_4} \quad (50)$$

$$U_{25} = -\frac{\beta}{\lambda_{\min}} \frac{\hat{c}_5^2 \|L\|^2 \sigma}{\hat{c}_5 \|L\| \|\sigma\| + \delta_5} \quad (51)$$

$$U_{26} = -\beta \frac{\|\tilde{u}_b\| \|\Lambda\|^2 \sigma}{\|\Lambda\| \|\sigma\| + \delta_6} \quad (52)$$

where  $\delta_k$  ( $k = 1, \dots, 6$ ) satisfies the conditions defined in Definition 3.1, and  $\hat{c}_\zeta$  denotes the estimate  $c_\zeta$ , which are adaptively tuned according to

$$\dot{\hat{c}}_1 = -\alpha_1 \hat{c}_1 + \frac{\gamma_1}{\lambda_{\min}} \|\sigma\| \|K_\sigma \sigma - \dot{\nu}\|, \quad \hat{c}_1(0) > 0 \quad (53)$$

$$\dot{\hat{c}}_2 = -\alpha_2 \hat{c}_2 + \frac{\gamma_2}{\lambda_{\min}} \|\sigma\| \|\sigma + \nu\|, \quad \hat{c}_2(0) > 0 \quad (54)$$

$$\dot{\hat{c}}_3 = -\alpha_3 \hat{c}_3 + \frac{\gamma_3}{\lambda_{\min}} \|\sigma\| \|\dot{\zeta}\| \|\sigma + \nu\|, \quad \hat{c}_3(0) > 0 \quad (55)$$

$$\dot{\hat{c}}_4 = -\alpha_4 \hat{c}_4 + \frac{\gamma_4}{\lambda_{\min}} \|\sigma\|, \quad \hat{c}_4(0) > 0 \quad (56)$$

$$\dot{\hat{c}}_5 = -\alpha_5 \hat{c}_5 + \frac{\gamma_5}{\lambda_{\min}} \|L\| \|\sigma\|, \quad \hat{c}_5(0) > 0 \quad (57)$$

with  $\alpha_\zeta > 0$  satisfying the condition in Definition 3.1 and  $\gamma_\zeta > 0$  ( $\zeta = 1, \dots, 5$ ), and

$$\Lambda = [\Lambda_1 \quad \Lambda_2]^T \quad (58)$$

$$\Lambda_i = \left[ k_1 s_{i1} + \sum_{j=2}^{n_{iv}-1} s_{ij} \zeta_{i(j+1)} - \sum_{j=3}^{n_{iv}} s_{ij} \sum_{k=2}^{j-1} \frac{\partial(e_{ik} - s_{ik})}{\partial e_{ik}} \zeta_{i(k+1)} \|s_{in_v}\| 0 \right]. \quad (59)$$

*Remark 3.1:* The variables  $U_{21}, \dots, U_{26}$  are to compensate for the parametric errors arising from estimating the unknown functions  $\mathcal{M}$ ,  $\mathcal{C}$ , and  $\mathcal{G}$  and the disturbance. The choice of the variables in (47)–(52) is to avoid the use of sign functions which will lead to chattering. Based on the definition of  $\delta_k$  in Definition 3.1, the denominators in (47)–(52) are nonnegative and will only approach zero when  $\delta_k \rightarrow 0$ . However, when  $\delta_k = 0$ , we can rewrite the equations in (47)–(52) as

$$U_{21} = -\frac{\beta}{\lambda_{\min}} \hat{c}_1 \|K_\sigma \sigma - \dot{\nu}\| \text{sgn}(\sigma)$$

$$U_{22} = -\frac{\beta}{\lambda_{\min}} \hat{c}_2 \|\sigma + \nu\| \text{sgn}(\sigma)$$

$$U_{23} = -\frac{\beta}{\lambda_{\min}} \hat{c}_3 \|\dot{\zeta}\| \|\sigma + \nu\| \text{sgn}(\sigma)$$

$$U_{24} = -\frac{\beta}{\lambda_{\min}} \hat{c}_4 \text{sgn}(\sigma)$$

$$U_{25} = -\frac{\beta}{\lambda_{\min}} \hat{c}_5 \|L\| \text{sgn}(\sigma)$$

$$U_{26} = -\beta \|\tilde{u}_b\| \|\Lambda\| \text{sgn}(\sigma).$$

From the aforementioned expressions, we can see that the variables  $U_{21}, \dots, U_{26}$  are bounded when  $\hat{c}_\zeta$ ,  $\zeta$ ,  $\sigma$ ,  $\nu$ ,  $\dot{\zeta}$ , and  $\Lambda$  are bounded. As such, there is no division by zero in the control design.

*Remark 3.2:* Noting (47)–(52), and the corresponding adaptive laws (53)–(57), the signals required for the implementation of the adaptive robust control are  $\sigma$ ,  $\dot{\nu}$ ,  $\nu$ ,  $\dot{\zeta}$ , and  $\Lambda$ . Acceleration measurements are not required for the adaptive robust control.

*Remark 3.3:* For the computation of the control  $\tau$ , we require the left inverse of the matrix  $\mathcal{B}$  to exist such that  $\mathcal{B}^+ \mathcal{B} = \mathcal{B}^T (\mathcal{B} \mathcal{B}^T)^{-1} \mathcal{B} = I$ . The matrix  $\mathcal{B}$  can be written as  $\mathcal{B} = \text{diag}[L_1^T T_2^T R_1^T B_1, L_2^T T_2^T R_2^T B_2]$ . From the definition of  $L_i$  in (31), we have that  $L_i^T \in \mathbb{R}^{(n_{ia}+m) \times (n_{ia}+m-\kappa_i)}$  is full row ranked, and the left inverse of  $L_i^T$  exists. The matrix  $R_i$  is defined as  $R_i(q_i) = \text{diag}[H_i(q_{ib}), I_{n_{ia} \times n_{ia}}] \in \mathbb{R}^{n_i \times (n_{ia}+m)}$ . Since  $H_i \in \mathbb{R}^{n_{iv} \times m}$  is formed by a set of  $m$  smooth and linearly independent vector fields, we have that  $R_i^T$  is full row ranked, and the left inverse of  $R_i^T$  exists.

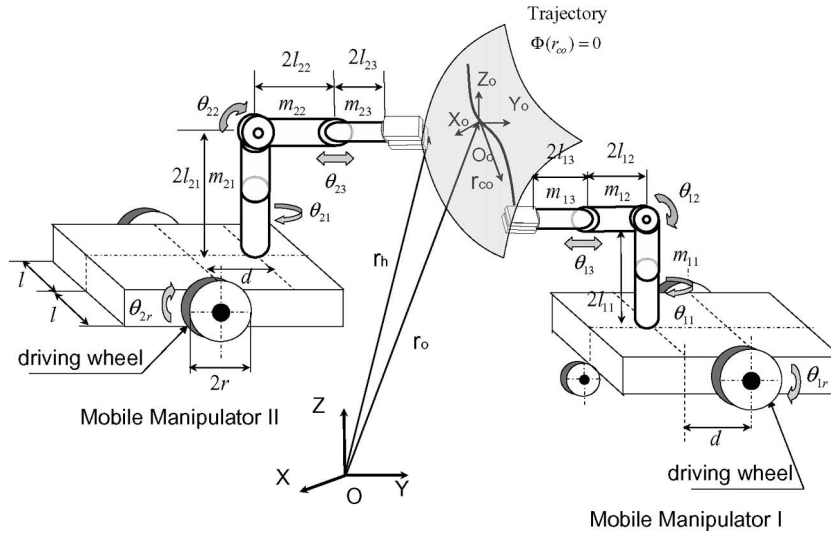

Fig. 3. Cooperating 3-DOF mobile manipulators.

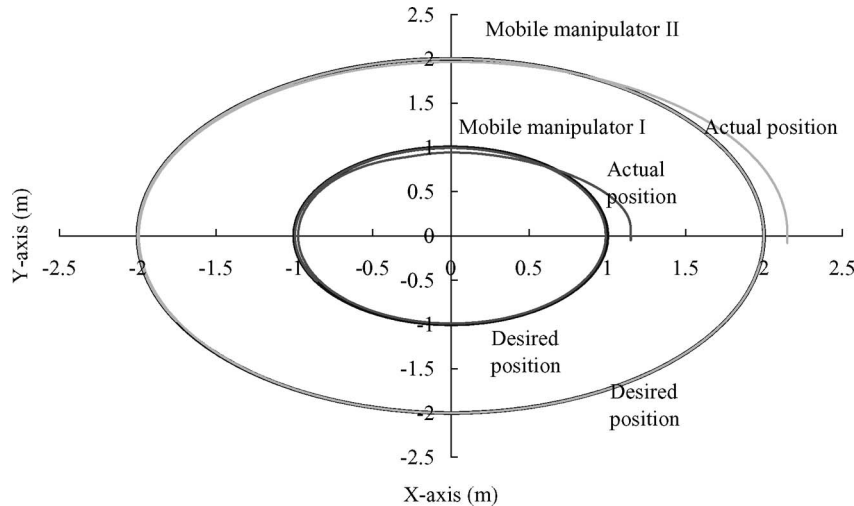

Fig. 4. Tracking trajectories of both mobile platforms.

Since the matrices  $L_i^T$  and  $R_i^T$  are full row ranked,  $B_i$  is a full-ranked input transformation matrix, and  $T_2$  is a diffeomorphism, there exists a left inverse of the matrix  $B$  such that  $B^+ B = B^T (B B^T)^{-1} B = I$ .

*Remark 3.4:* Application of sliding-mode control generally leads to the introduction of the  $\text{sgn}$  function in the control laws, which would lead to the chattering phenomenon in the practical control [18]. To reduce the chattering phenomenon, we introduce positive time-varying functions  $\delta_j$ , with properties described in Definition 3.1, in the control laws (45)–(50), such that the controls are continuous for  $\delta_j \neq 0$ .

C. Control Stability

*Theorem 3.1:* Considering the mechanical system described by (27), under Assumption 2.2, using the control law (44), the following can be achieved.

- 1)  $e_\zeta = \zeta - \zeta_d$ ,  $\dot{e}_\zeta = \dot{\zeta} - \dot{\zeta}_d$ , and  $e_\lambda = \lambda_c - \lambda_c^d$  converge to a small set containing the origin as  $t \rightarrow \infty$ .

- 2) All the signals in the closed loop are bounded for all  $t \geq 0$ .

*Proof:* See Appendix B. ■

IV. SIMULATION STUDIES

To verify the effectiveness of the proposed control algorithm, we consider two similar 3-DOF mobile manipulator systems shown in Fig. 3. Both mobile manipulators are subjected to the following constraint:

$$\dot{x}_i \cos \theta_i + \dot{y}_i \sin \theta_i = 0, \quad i = 1, 2.$$

Using the Lagrangian approach, we can obtain the standard form for (17) and (18) with  $q_{iv} = [x_i, y_i, \theta_i]^T$ ,  $q_{ia} = [\theta_{i1}, \theta_{i2}, \theta_{i3}]^T$ , where  $\theta_{i2} = \pi/2$  and is fixed,  $q_i = [q_{iv}, q_{ia}]^T$ , and  $A_i = [\cos \theta_i, \sin \theta_i, 0]^T$  and

$$M_{iv} = \begin{bmatrix} M_{iv11} & M_{iv12} \\ M_{iv21} & M_{iv22} \end{bmatrix}, \quad C_{iv} = \begin{bmatrix} C_{iv11} & C_{iv12} \\ C_{iv21} & C_{iv22} \end{bmatrix},$$



$$B_{iv} = \begin{bmatrix} \sin \theta_i / r & -\cos \theta_i / r & -l / r \\ -\sin \theta_i / r & \cos \theta_i / r & l / r \end{bmatrix}^T, \quad M_{iv12} = [m_{i1i2i3}d \cos \theta_i + m_{i2i3} \cos(\theta_i + \theta_{i1}), m_{i1i2i3}d \sin \theta_i + m_{i2i3} \sin(\theta_i + \theta_{i1})]^T, \quad M_{iv11} = \text{diag}[m_{ipi1i2i3}], \quad m_{i2i3} = m_{i2}l_{i2} + m_{i3}L_{i3}, \quad L_{i3} = 2l_{i2} + l_{i3} + \theta_{i3}, \quad M_{iv22} = I_{ip} + I_{i1i2i3} + m_{i1i2i3}d^2 + m_{i2}(l_{i2}^2 + 2dl_{i2} \cos \theta_{i1}) + m_{i3}(L_{i3}^2 + 2dL_{i3} \cos \theta_{i1}), \quad M_{iva} = [M_{iva1}, M_{iva2}, M_{iva3}], \quad M_{iva1} = [m_{i2i3} \cos(\theta_i + \theta_{i1}), m_{i2i3} \sin(\theta_i + \theta_{i1}), I_{i1i2i3} + m_{i2}(l_{i2}^2 + 2dl_{i2} \cos \theta_{i1}) + m_{i3}(L_{i3}^2 + 2dL_{i3} \cos \theta_{i1})]^T, \quad M_{iva2} = 0.0, \quad M_{iva3} = [\sin(\theta_i + \theta_{i1}), -\cos(\theta_i + \theta_{i1}), 0]^T, \quad B_{ia} = \text{diag}[1.0], \quad M_{ia} = \text{diag}[I_{i1i2i3}, I_{i2i3}, m_{i3}], \quad \tau_i = [\tau_{il}, \tau_{ir}, \tau_{i1}, \tau_{i2}, \tau_{i3}]^T, \quad G_{iv} = [0.0, 0.0, 0.0]^T, \quad m_{ipi1i2i3} = m_{ip} + m_{i1i2i3}, \quad m_{i1i2i3} = m_{i1} + m_{i2} + m_{i3}, \quad I_{i1i2i3} = I_{i1} + I_{i2} + I_{i3} + m_{i3}L_{i3}^2, \quad I_{i2i3} = I_{i2} + I_{i3} + m_{i3}L_{i3}^2, \quad C_{iv11} = 0, \quad C_{iv12} = C_{iv21}^T, \quad C_{iv22} = -2m_{i2i3}d \sin \theta_{i1} \dot{\theta}_{i1}, \quad C_{ia} = \text{diag}[-m_{i2i3}d \sin \theta_{i1} \dot{\theta}_i, -m_{i2i3}d \sin \theta_{i1} \dot{\theta}_i, 0], \quad C_{iv12} = [-m_{i1i2i3}d \dot{\theta}_i \sin \theta_i - m_{i2i3} \sin(\theta_i + \theta_{i1})(\dot{\theta}_i + \dot{\theta}_{i1}), m_{i1i2i3}d \dot{\theta}_i \cos \theta_i + m_{i2i3} \cos(\theta_i + \theta_{i1})(\dot{\theta}_i + \dot{\theta}_{i1})]^T, \quad G_{ia} = [0.0, m_{i2}gl_{i2}, m_{i3}gL_{i3}]^T, \quad C_{iva} = [C_{iva1}, C_{iva2}, C_{iva3}], \quad C_{iva1} = C_{iva2} = [-m_{i2i3} \sin(\theta_i + \theta_{i1})(\dot{\theta}_i + \dot{\theta}_{i1}), -m_{i2i3} \sin \cos(\theta_i + \theta_{i1})(\dot{\theta}_i + \dot{\theta}_{i1}), 0]^T, \quad C_{iva3} = [-m_{i3} \cos(\theta_i + \theta_{i1})(\dot{\theta}_i + \dot{\theta}_{i1}), -m_{i3} \sin \cos(\theta_i + \theta_{i1})(\dot{\theta}_i + \dot{\theta}_{i1}), 0]^T, \quad C_{iav1} = C_{iav1}^T, \quad C_{iav2} = C_{iav2}^T, \quad \text{and } C_{iav3} = [m_{i3} \cos(\theta_i + \theta_{i1})(\dot{\theta}_i + \dot{\theta}_{i1}), m_{i3} \sin(\theta_i + \theta_{i1})(\dot{\theta}_i + \dot{\theta}_{i1}), m_{i3}d \sin \theta_i \dot{\theta}_{i1}]. \quad \text{The disturbances are } d_1 = d_2 = [0.5 \sin(t), 0.5 \sin(t), 0, 0.1 \sin(t), 0.1 \sin(t), 0.1 \sin(t)]^T.$$

The parameters of the mobile manipulators used in this simulation are as follows:  $m_{1p} = m_{2p} = 5.0$  kg,  $m_{11} = m_{21} = 1.0$  kg,  $m_{12} = m_{22} = m_{13} = m_{23} = 0.5$  kg,  $I_{1w} = I_{2w} = 1.0$  kg · m<sup>2</sup>,  $I_{1p} = I_{2p} = 2.5$  kg · m<sup>2</sup>,  $I_{11} = I_{21} = 1.0$  kg · m<sup>2</sup>,  $I_{12} = I_{22} = 0.5$  kg · m<sup>2</sup>,  $I_{13} = I_{23} = 0.5$  kg · m<sup>2</sup>,  $d = l = r = 0.5$  m,  $2l_{11} = 2l_{21} = 1.0$  m,  $2l_{12} = 2l_{22} = 0.5$  m,  $2l_{13} = 0.05$  m, and  $2l_{23} = 0.35$  m. The mass of the object is  $m_{\text{obj}} = 0.5$  kg. The parameters are used for simulation purposes only; they are assumed to be unknown and are not used in the control design. The desired trajectory of the object is  $r_{od} = [x_{od}, y_{od}, z_{od}]^T$ , where  $x_{od} = 1.5 \cos(t)$ ,  $y_{od} = 1.5 \sin(t)$ , and  $z_{od} = 2l_1$ . The corresponding desired trajectory of mobile manipulator II is  $q_{2d} = [x_{2d}, y_{2d}, \theta_{2d}, \theta_{21d}, \theta_{22d}]^T$ , with  $x_d = 2.0 \cos(t)$ ,  $y_d = 2.0 \sin(t)$ ,  $\theta_d = t$ ,  $\theta_{22d} = \pi/2$  rad, and  $\theta_{21d}, \theta_{23}$  are to control the force and compensate the task space errors. The end effector holds tightly on the top point of the surface. The constraint relative motion by mobile manipulator I is an arc with the center on joint 2 of mobile manipulator I, where angle =  $\pi/2 - \pi/6 \cos(t)$ , and the constraint force is set as  $\lambda_c^d = 10.0$  N. Therefore, from the constraint relative motion, we can obtain the desired trajectory of mobile manipulator I as  $q_{1d} = [x_{1d}, y_{1d}, \theta_{1d}, \theta_{11d}, \theta_{12d}]^T$  with the corresponding trajectories  $x_{1d} = 1.0 \cos(t)$ ,  $y_{1d} = 1.0 \sin(t)$ ,  $\theta_{1d} = t$ ,  $\theta_{11d} = \pi/2 - \pi/6 \cos(t)$ , and  $\theta_{12} = \pi/2$ , and  $\theta_{13}$  is used to compensate the position errors of the mobile platform.

For each mobile manipulator, by the transformation similar to (25) and (26),  $T_{11}(q_{ib}) = [\theta_i, x_i \cos(\theta_i) + y_i \sin(\theta_i), -x_i \sin(\theta_i) + y_i \cos(\theta_i)]^T$  and  $u_{ib} = [v_{i2}, v_{i1} - (x_i \cos(\theta_i) + y_i \sin(\theta_i))v_{i2}]^T$ . One can obtain the kinematic system in the chained form  $\dot{\zeta}_i = [u_{i1}, \zeta_{i3}u_{i1}, u_{i2}, u_{i3}, u_{i4}]^T$ .

The robust adaptive control (44) is used, the tracking errors for both mobile manipulators are given by  $[e_i^T, e_{\lambda_c}]^T = [\zeta_i^T - \zeta_i^{dT}, \lambda_c - \lambda_c^d]^T$ , and  $s_i^T = [e_{i1}, e_{i2}, e_{i3} + k_{i2}e_{i2}u_{id1}]^T$ .

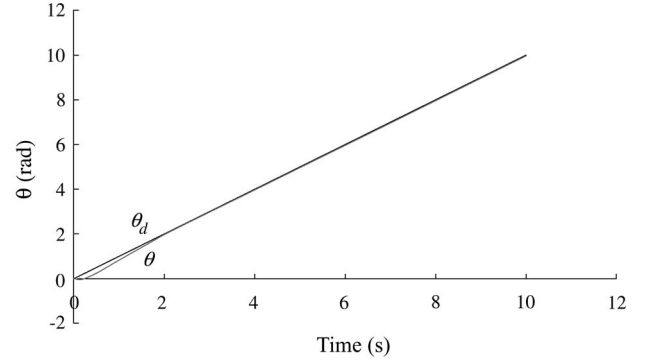
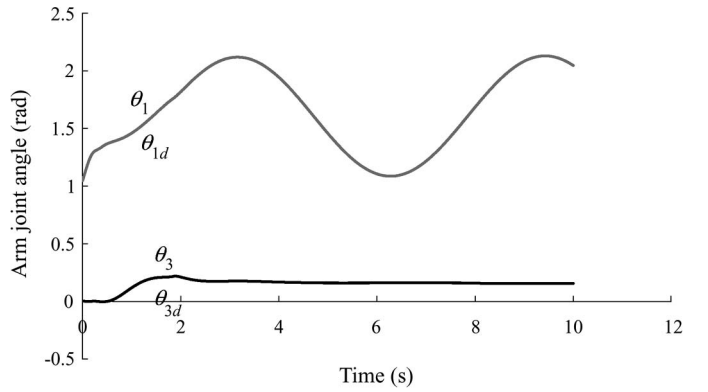
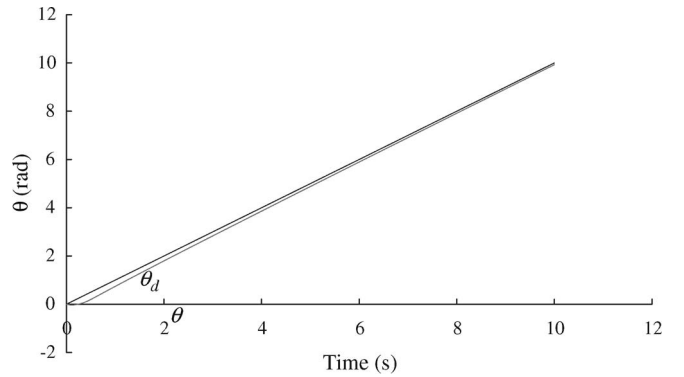

 Fig. 5. Tracking of  $\theta$  for mobile manipulator I.

Fig. 6. Tracking of arm joint angles of mobile manipulator I.

 Fig. 7. Tracking of  $\theta$  for mobile manipulator II.

The initial conditions selected for mobile manipulator I are  $x_1(0) = 1.15$  m,  $y_1(0) = 0.0$  m,  $\theta_1(0) = 0.0$  rad,  $\theta_{11}(0) = 1.047$  rad,  $\theta_{12}(0) = \pi/2$  rad,  $\theta_{13}(0) = 0.0$  rad,  $\lambda(0) = 0.0$  N,  $\dot{x}_1(0) = 0.5$  m/s, and  $\dot{y}_1(0) = \dot{\theta}_1(0) = \dot{\theta}_{11}(0) = \dot{\theta}_{12}(0) = \dot{\theta}_{13}(0) = 0.0$ , and the initial conditions selected for mobile manipulator II are  $x_2(0) = 2.15$  m,  $y_2(0) = 0$  m,  $\theta_2(0) = 0.0$  rad,  $\theta_{21}(0) = 1.57$  rad,  $\theta_{22}(0) = \pi/2$  rad,  $\theta_{23}(0) = 0.0$  rad, and  $\dot{x}_2(0) = \dot{y}_2(0) = \dot{\theta}_2(0) = \dot{\theta}_{12}(0) = \dot{\theta}_{22}(0) = \dot{\theta}_{23}(0) = 0.0$ .

In the simulation, the design parameters are selected as  $k_0 = 5.0$ ,  $k_1 = 180.0$ ,  $k_2 = 5.0$ ,  $k_3 = 5.0$ ,  $\eta(0) = 0.0$ ,  $K_{a1} = \text{diag}[2.0]$ ,  $K_\lambda = 0.3$ ,  $K_I = 1.5$ ,  $K_\sigma = \text{diag}[0.5]$ ,  $K_u = \text{diag}[1.0]$ ,  $\gamma_i = 0.1$ ,  $\alpha_i = \delta_i = 1/(1+t)^2$ , and  $\hat{c}_i(0) = 1.0$ . Fig. 4 shows the trajectory of the mobile platforms of both mobile manipulators. Figs. 5–8 show the tracking performance, and the corresponding input torques

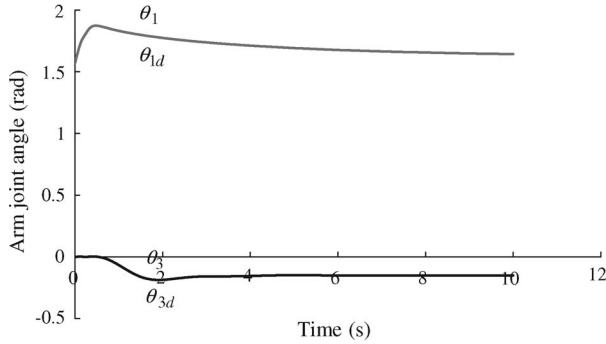

Fig. 8. Tracking of arm joint angles of mobile manipulator II.

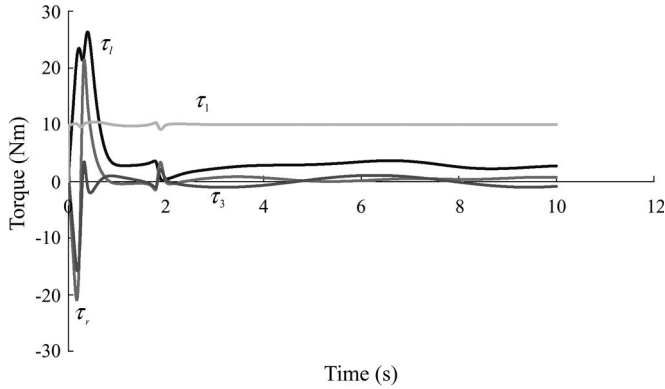

Fig. 9. Input torques for mobile manipulator I.

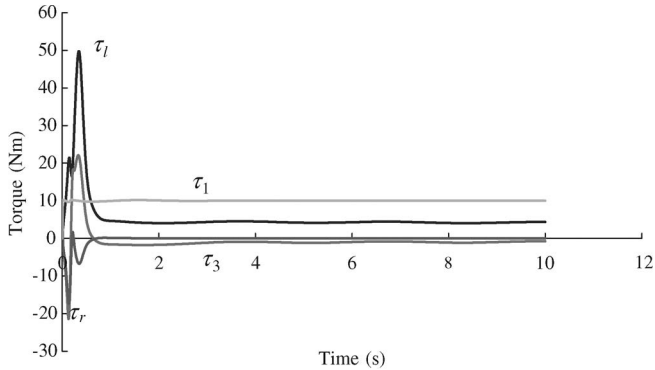

Fig. 10. Torques of mobile manipulator II.

are shown in Figs. 9 and 10. Fig. 11 shows the contact force tracking  $\lambda_c - \lambda_c^d$ , since joint 3 makes the manipulator redundant in the force space. From Fig. 11, we can see that the contact force is always more than zero, which means that the two mobile manipulators always keep in contact, and the force error converges to zero through the selection of  $K_\lambda$  and  $K_I$ .

## V. CONCLUSION

In this paper, the dynamics and control of two mobile robotic manipulators manipulating a constrained object have been investigated. In addition to the motion of the object with respect to the world coordinates, its relative motion with respect to the mobile manipulators is also taken into consideration. The dynamics of such a system is established, and its properties are discussed. Robust adaptive controls have been developed, which can guarantee the convergence of positions and bounded-

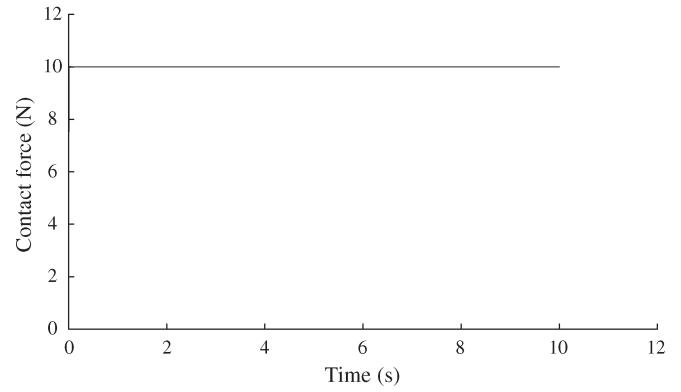

Fig. 11. Contact force of relative motion.

ness of the constraint force. The control signals are smooth, and no projection is used in the parameter update law. Simulation results illustrate the performance of the proposed controls.

## APPENDIX A TRANSFORMATION INTO THE CHAINED SYSTEM

*Proposition A.1:* Consider the drift-free nonholonomic system

$$\dot{q}_v = r_1(q_v)\dot{z}_1 + \cdots + r_m(q_v)\dot{z}_m$$

where  $r_i(q_v)$  are smooth linearly independent input vector fields. There exist state transformation  $X = \mathcal{T}_1(q_v)$  and feedback  $\dot{z} = \mathcal{T}_2(q_v)u_b$  on some open set  $U \subset \mathbb{R}^n$  to transform the system into an  $(m-1)$ -chain single-generator chained form if and only if there exists a basis  $f_1, \dots, f_m$  for  $\Delta_0 := \text{span}\{r_1, \dots, r_m\}$  which has the form

$$f_1 = (\partial/\partial q_{v1}) + \sum_{i=2}^{n_v} f_1^i(q_v)\partial/\partial q_{vi}$$

$$f_j = \sum_{i=2}^n f_j^i(q_v)\partial/\partial q_{vi}, \quad 2 \leq j \leq m$$

such that the distributions

$$G_j = \text{span}\{\text{ad}_{f_1}^i f_2, \dots, \text{ad}_{f_1}^i f_m : 0 \leq i \leq j\},$$

$$0 \leq j \leq n_v - 1$$

have constant dimension on  $U$  and are all involutive, and  $G_{n_v-1}$  has dimension  $n_v - 1$  on  $U$  [13].

## APPENDIX B PROOF OF THEOREM 3.1

*Proof:* Combining the dynamic equation (41) together with (38), (39), and (44), the close-loop system dynamics can be written as

$$M\dot{\sigma} = -M\dot{\nu} - C(\nu + \sigma) - G - d + B\tau + J^T\lambda \quad (60)$$

$$\dot{\eta}_i = -k_0\eta_i - \Lambda_{i1} \quad (61)$$

$$\dot{s}_{i1} = \eta_i + \tilde{u}_{i1} \quad (62)$$

$$\dot{s}_{i2} = (\eta_i + \tilde{u}_{i1})\zeta_{i3} + s_{i3}u_{id1} - k_2s_{i2}u_{id1}^2 \quad (63)$$

$$\begin{aligned} \dot{s}_{i3} &= (\eta_i + \tilde{u}_{i1}) \left( \zeta_{i4} - \frac{\partial(e_{i3} - s_{i3})}{\partial e_{i2}} \zeta_{i3} \right) \\ &\quad + s_{i4} u_{id1} - s_{i2} u_{id1} - k_3 s_{i3} u_{id1}^{2l} \\ &\quad \vdots \end{aligned} \quad (64)$$

$$\begin{aligned} \dot{s}_{i(n_{iv}-1)} &= (\eta_i + \tilde{u}_{i1}) \zeta_{in_{iv}} - k_{(n_{iv}-1)} \\ &\quad \times s_{i(n_{iv}-1)} u_{id1}^{2l} - (\eta_i + \tilde{u}_{i1}) \\ &\quad \times \left( \sum_{j=2}^{n_{iv}-2} \frac{\partial(e_{i(n_{iv}-1)} - s_{i(n_{iv}-1)})}{\partial e_{ji}} \zeta_{i(j+1)} \right) \\ &\quad + s_{in_{iv}} u_{id1} - s_{i(n_{iv}-2)} u_{id1} \end{aligned} \quad (65)$$

$$\begin{aligned} \dot{s}_{in_{iv}} &= (\eta_i + \tilde{u}_{i1}) \sum_{j=2}^{n_{iv}-2} \frac{\partial(e_{in_{iv}} - s_{in_{iv}})}{\partial e_{ij}} \zeta_{i(j+1)} \\ &\quad - k_{n_{iv}} s_{in_{iv}} - s_{i(n_{iv}-1)} u_{id1} + \tilde{u}_{i2}. \end{aligned} \quad (66)$$

Let  $\mathcal{D} = L^T d$ . Multiplying  $L^T$  on both sides of (60), using (44), one can obtain

$$\begin{aligned} \mathcal{M}\dot{\sigma} &= -\mathcal{M}_0 K_\sigma \sigma + (\mathcal{M}_0 - \mathcal{M})\dot{\nu} + (\mathcal{C}_0 - \mathcal{C})(\nu + \sigma) \\ &\quad + (\mathcal{G}_0 - \mathcal{G}) - \mathcal{D} + U_2 \\ &= -\mathcal{M} K_\sigma \sigma + \Delta M (K_\sigma \sigma - \dot{\nu}) - \Delta C (\nu + \sigma) - \Delta G \\ &\quad - \mathcal{D} + \sum_{i=1}^6 U_{2i} \end{aligned} \quad (67)$$

where

$$\begin{aligned} \dot{\sigma} &= -K_\sigma \sigma + \mathcal{M}^{-1} \Delta M (K_\sigma \sigma - \dot{\nu}) - \mathcal{M}^{-1} \Delta C (\nu + \sigma) \\ &\quad - \mathcal{M}^{-1} \Delta G - \mathcal{M}^{-1} \mathcal{D} + \mathcal{M}^{-1} \sum_{i=1}^6 U_{2i}. \end{aligned} \quad (68)$$

Consider the following positive-definite functions:

$$\begin{aligned} V &= V_1 + V_2 \\ V_1 &= \frac{1}{2} \sum_{i=1}^2 \sum_{j=2}^{n_{iv}} s_{ij}^2 + \frac{1}{2} \sum_{i=1}^2 k_{i1} s_{i1}^2 + \frac{1}{2} \sum_{i=1}^2 \eta_i^2 \\ V_2 &= \frac{1}{2} \sigma^T \sigma + \sum_{\varsigma=1}^5 \frac{1}{2\gamma_\varsigma} \tilde{c}_\varsigma^2 \end{aligned} \quad (69)$$

where  $\tilde{c}_\varsigma := \hat{c}_\varsigma - c_\varsigma$ . Taking the time derivative of  $V_1$  with (61)–(66) results in

$$\begin{aligned} \dot{V}_1 &= \sum_{i=1}^2 \sum_{j=2}^{n_{iv}-1} s_{ij} \dot{s}_{ij} + \sum_{i=1}^2 k_{i1} s_{i1} \dot{s}_{i1} + \sum_{i=1}^2 \eta_i \dot{\eta}_i \\ &= -\sum_{i=1}^2 \left( \sum_{j=2}^{n_{iv}-1} k_{ij} s_{ij}^2 u_{id1}^{2l} + k_{in_{iv}} s_{in_{iv}}^2 + k_0 \eta_i^2 + \tilde{u}_b^T \Lambda \right). \end{aligned} \quad (70)$$

Taking the time derivative of  $V_2$  and integrating (68) result in

$$\begin{aligned} \dot{V}_2 &= -\sigma^T K_\sigma \sigma + \sigma^T \mathcal{M}^{-1} U_{26} \\ &\quad + \left[ \sigma^T \mathcal{M}^{-1} \Delta M (K_\sigma \sigma - \dot{\nu}) + \sigma^T \mathcal{M}^{-1} U_{21} + \frac{\tilde{c}_1 \dot{\hat{c}}_1}{\gamma_1} \right] \\ &\quad + \left[ -\sigma^T \mathcal{M}^{-1} \Delta C (\sigma + \nu) + \sum_{\varsigma=2}^3 \left( \sigma^T \mathcal{M}^{-1} U_{2\varsigma} + \frac{\tilde{c}_\varsigma \dot{\hat{c}}_\varsigma}{\gamma_\varsigma} \right) \right] \\ &\quad + \left[ -\sigma^T \mathcal{M}^{-1} \Delta G + \sigma^T \mathcal{M}^{-1} U_{24} + \frac{\tilde{c}_4 \dot{\hat{c}}_4}{\gamma_4} \right] \\ &\quad + \left[ -\sigma^T \mathcal{M}^{-1} \mathcal{D} + \sigma^T \mathcal{M}^{-1} U_{25} + \frac{\tilde{c}_5 \dot{\hat{c}}_5}{\gamma_5} \right]. \end{aligned} \quad (71)$$

Considering Property 2.2, Assumption 3.1, and (47), the third right-hand term of (71) is bounded by

$$\begin{aligned} &\sigma^T \mathcal{M}^{-1} \Delta M (K_\sigma \sigma - \dot{\nu}) + \sigma^T \mathcal{M}^{-1} U_{21} + \frac{1}{\gamma_1} \tilde{c}_1 \dot{\hat{c}}_1 \\ &\leq \frac{c_1}{\lambda_{\min}} \|K_\sigma \sigma - \dot{\nu}\| \|\sigma\| \\ &\quad - \frac{1}{\lambda_{\min}} \frac{\hat{c}_1^2 \|K_\sigma \sigma - \dot{\nu}\|^2 \|\sigma\|^2}{\hat{c}_1 \|K_\sigma \sigma - \dot{\nu}\| \|\sigma\| + \delta_1} + \frac{1}{\gamma_1} \tilde{c}_1 \dot{\hat{c}}_1 \\ &= \frac{\hat{c}_1}{\lambda_{\min}} \|K_\sigma \sigma - \dot{\nu}\| \|\sigma\| - \frac{1}{\lambda_{\min}} \frac{\hat{c}_1^2 \|K_\sigma \sigma - \dot{\nu}\|^2 \|\sigma\|^2}{\hat{c}_1 \|K_\sigma \sigma - \dot{\nu}\| \|\sigma\| + \delta_1} \\ &\quad + \tilde{c}_1 \left[ \frac{1}{\gamma_1} \dot{\hat{c}}_1 - \frac{1}{\lambda_{\min}} \|K_\sigma \sigma - \dot{\nu}\| \|\sigma\| \right] \\ &\leq \frac{\delta_1}{\lambda_{\min}} - \frac{\alpha_1}{\gamma_1} \tilde{c}_1 \dot{\hat{c}}_1 \leq \frac{\delta_1}{\lambda_{\min}} - \frac{\alpha_1}{\gamma_1} \left( \hat{c}_1 - \frac{1}{2} c_1 \right)^2 + \frac{\alpha_1}{4\gamma_1} c_1^2. \end{aligned} \quad (72)$$

The last inequality obtained is because  $-\tilde{c}_1 \dot{\hat{c}}_1 = -(\hat{c}_1 - (1/2)c_1)^2 + (1/4)c_1^2$ .

Similarly, considering Property 2.2, Assumption 3.1, (48), and (49), the fourth right-hand term of (71) is bounded by

$$\begin{aligned} &-\sigma^T \mathcal{M}^{-1} \Delta C (\sigma + \nu) \sum_{\varsigma=2}^3 \left( \sigma^T \mathcal{M}^{-1} U_{2\varsigma} + \frac{\tilde{c}_\varsigma \dot{\hat{c}}_\varsigma}{\gamma_\varsigma} \right) \\ &\leq \frac{1}{\lambda_{\min}} \left[ \left( c_2 + c_3 \|\dot{\zeta}\| \right) \|\sigma + \nu\| \|\sigma\| \right. \\ &\quad \left. - \frac{\hat{c}_2^2 \|\sigma + \nu\|^2 \|\sigma\|^2}{\hat{c}_2 \|\sigma + \nu\| \|\sigma\| + \delta_2} \right] + \frac{1}{\gamma_2} \tilde{c}_2 \dot{\hat{c}}_2 \\ &\quad - \frac{1}{\lambda_{\min}} \frac{\hat{c}_3^2 \|\dot{\zeta}\|^2 \|\sigma + \nu\|^2 \|\sigma\|^2}{\hat{c}_3 \|\dot{\zeta}\| \|\sigma + \nu\| \|\sigma\| + \delta_2} + \frac{1}{\gamma_3} \tilde{c}_3 \dot{\hat{c}}_3 \\ &= \frac{1}{\lambda_{\min}} \hat{c}_2 \|\sigma + \nu\| \|\sigma\| - \frac{1}{\lambda_{\min}} \frac{\hat{c}_2^2 \|\sigma + \nu\|^2 \|\sigma\|^2}{\hat{c}_2 \|\sigma + \nu\| \|\sigma\| + \delta_2} \\ &\quad + \tilde{c}_2 \left[ \frac{1}{\gamma_2} \dot{\hat{c}}_2 - \frac{1}{\lambda_{\min}} \|\sigma + \nu\| \|\sigma\| \right] \end{aligned}$$

$$\begin{aligned}
& + \frac{\hat{c}_3}{\lambda_{\min}} \|\dot{\zeta}\| \|\sigma + \nu\| \|\sigma\| - \frac{\hat{c}_3^2}{\lambda_{\min} \hat{c}_3} \frac{\|\dot{\zeta}\|^2 \|\sigma + \nu\|^2 \|\sigma\|^2}{\|\dot{\zeta}\| \|\sigma + \nu\| \|\sigma\| + \delta_3} \\
& + \tilde{c}_3 \left[ \frac{1}{\gamma_3} \dot{\hat{c}}_3 - \frac{1}{\lambda_{\min}} \|\dot{\zeta}\| \|\sigma + \nu\| \|\sigma\| \right] \\
& \leq \sum_{\varsigma=2}^3 \frac{1}{\lambda_{\min}} \delta_{\varsigma} - \frac{\alpha_{\varsigma}}{\gamma_{\varsigma}} \left( \hat{c}_{\varsigma} - \frac{1}{2} c_{\varsigma} \right)^2 + \frac{\alpha_{\varsigma}}{4\gamma_{\varsigma}} c_{\varsigma}^2. \quad (73)
\end{aligned}$$

Similarly, considering Property 2.2, Assumption 3.1, and (50), the fifth right-hand term of (71) is bounded by

$$\begin{aligned}
& \sigma^T M^{-1} \Delta G + \sigma^T M^{-1} u_{24} + \frac{1}{\gamma_4} \tilde{c}_4 \dot{\hat{c}}_4 \\
& \leq \frac{c_4 \|\sigma\|}{\lambda_{\min}} - \frac{1}{\lambda_{\min}} \frac{\hat{c}_4^2 \|\sigma\|^2}{\hat{c}_4 \|\sigma\| + \delta_4} + \frac{\tilde{c}_4 \dot{\hat{c}}_4}{\gamma_4} \\
& = \frac{\hat{c}_4 \|\sigma\|}{\lambda_{\min}} - \frac{1}{\lambda_{\min}} \frac{\hat{c}_4^2 \|\sigma\|^2}{\hat{c}_4 \|\sigma\| + \delta_4} + \tilde{c}_4 \left[ \frac{\dot{\hat{c}}_4}{\gamma_4} - \frac{\|\sigma\|}{\lambda_{\min}} \right] \\
& \leq \frac{1}{\lambda_{\min}} \delta_4 - \frac{\alpha_4}{\gamma_4} \left( \hat{c}_4 - \frac{1}{2} c_4 \right)^2 + \frac{\alpha_4}{4\gamma_4} c_4^2. \quad (74)
\end{aligned}$$

Similarly, considering Property 2.2, Assumption 3.1, and (51), the sixth right-hand term of (71) is bounded by

$$\begin{aligned}
& \sigma^T \mathcal{M}^{-1} \mathcal{D} + \sigma^T \mathcal{M}^{-1} u_{25} + \frac{1}{\gamma_5} \tilde{c}_5 \dot{\hat{c}}_5 \\
& \leq \frac{1}{\lambda_{\min}} c_5 \|L\| \|\sigma\| - \frac{1}{\lambda_{\min}} \frac{\hat{c}_5^2 \|L\|^2 \|\sigma\|^2}{\hat{c}_5 \|L\| \|\sigma\| + \delta_5} + \frac{1}{\gamma_5} \tilde{c}_5 \dot{\hat{c}}_5 \\
& = \frac{1}{\lambda_{\min}} \hat{c}_5 \|L\| \|\sigma\| - \frac{1}{\lambda_{\min}} \frac{\hat{c}_5^2 \|L\|^2 \|\sigma\|^2}{\hat{c}_5 \|L\| \|\sigma\| + \delta_5} \\
& \quad + \tilde{c}_5 \left[ \frac{1}{\gamma_5} \dot{\hat{c}}_5 - \frac{1}{\lambda_{\min}} \|L\| \|\sigma\| \right] \\
& \leq \frac{1}{\lambda_{\min}} \delta_5 - \frac{\alpha_5}{\gamma_5} \left( \hat{c}_5 - \frac{1}{2} c_5 \right)^2 + \frac{\alpha_5}{4\gamma_5} c_5^2. \quad (75)
\end{aligned}$$

Combining (70) and (71), we obtain

$$\begin{aligned}
\dot{V} & \leq -\sum_{i=1}^2 \sum_{j=2}^{n_{iv}-1} k_{ij} s_{ij}^2 u_{id1}^{2l} - \sum_{i=1}^2 k_{in_{iv}} s_{in_{iv}}^2 - \sum_{i=1}^2 k_0 \eta_i^2 \\
& \quad + \tilde{u}_b^T \Lambda - \sigma^T K_{\sigma} \sigma - \sum_{\varsigma=1}^5 \frac{\alpha_{\varsigma}}{\gamma_{\varsigma}} \left( \hat{c}_{\varsigma} - \frac{1}{2} c_{\varsigma} \right)^2 \\
& \quad + \frac{1}{\lambda_{\min}} \sum_{k=1}^5 \delta_k + \sum_{\varsigma=1}^5 \frac{\alpha_{\varsigma}}{4\gamma_{\varsigma}} c_{\varsigma}^2 + \sigma^T \mathcal{M}^{-1} U_{26}. \quad (76)
\end{aligned}$$

Considering Property 2.2 and (52), the fourth and ninth right-hand terms of (76) are bounded by

$$\tilde{u}_b^T \Lambda + \sigma^T \mathcal{M}^{-1} U_{26} \leq \|\tilde{u}_b\| \|\Lambda\| - \frac{\|\tilde{u}_b\| \|\Lambda\|^2 \|\sigma\|^2}{\|\Lambda\| \|\sigma\|^2 + \delta_6} \leq \delta_6. \quad (77)$$

Therefore, we can rewrite (76) as

$$\begin{aligned}
\dot{V} & \leq -\sum_{i=1}^2 \left( \sum_{j=2}^{n_{iv}-1} k_{ij} s_{ij}^2 u_{id1}^{2l} + k_{in_{iv}} s_{in_{iv}}^2 + k_0 \eta_i^2 \right) \\
& \quad - \sigma^T K_{\sigma} \sigma - \sum_{\varsigma=1}^5 \frac{\alpha_{\varsigma}}{\gamma_{\varsigma}} \left( \hat{c}_{\varsigma} - \frac{1}{2} c_{\varsigma} \right)^2 \\
& \quad + \sum_{\varsigma=1}^5 \left( \frac{\delta_{\varsigma}}{\lambda_{\min}} + \frac{\alpha_{\varsigma} c_{\varsigma}^2}{4\gamma_{\varsigma}} \right) + \delta_6. \quad (78)
\end{aligned}$$

Noting Definition 3.1, we have  $\mathcal{F} = (1/\lambda_{\min}) \sum_{k=1}^5 \delta_k + \sum_{\varsigma=1}^5 (\alpha_{\varsigma}/4\gamma_{\varsigma}) c_{\varsigma}^2 + \delta_6 \rightarrow 0$  as  $t \rightarrow \infty$ .

We define  $\mathcal{A} = \sum_{i=1}^2 k_0 \eta_i^2 + \sum_{i=1}^2 k_{in_{iv}} s_{in_{iv}}^2 + \sum_{i=1}^2 \times \sum_{j=2}^{n_{iv}-1} k_{ij} s_{ij}^2 u_{id1}^{2l} + \lambda_{\min} (K_{\sigma}) \|\sigma\|^2 + \sum_{\varsigma=1}^5 (\alpha_{\varsigma}/\gamma_{\varsigma}) (\hat{c}_{\varsigma} - (1/2)c_{\varsigma})^2$ , and from the definition, we have  $\mathcal{A} > 0 \forall \eta_i, s_{in_{iv}}, s_{ij}, u_{id1}, \sigma$ , and  $c_{\varsigma}$ , where  $i = 1, 2$  and  $\varsigma = 1, \dots, 5$ .

Integrating both sides of (78) gives

$$V(t) - V(0) \leq -\int_0^t \mathcal{A} ds + \int_0^t \mathcal{F} ds < -\int_0^t \mathcal{A} ds + \mathcal{C} \quad (79)$$

where  $\mathcal{C} = \sum_{k=1}^5 (a_k/\lambda_{\min}) + \sum_{\varsigma=1}^5 (b_{\varsigma}/4\gamma_{\varsigma}) c_{\varsigma}^2 + a_6$  is a finite constant from Definition 3.1; we have  $V(t) < V(0) - \int_0^t \mathcal{A} ds + \mathcal{C}$ . Thus,  $V$  is bounded, and subsequently,  $\eta_i, s_i, \sigma, \hat{c}_i$ , and  $\nu$  are bounded. From the definition of  $s_i$  in (38), it is concluded that  $[e_{i1}, e_{i2}, \dots, e_{in_{iv}}]^T$  is bounded, which follows that  $\eta$  is bounded. From (79), we have  $s_{ij} u_{id1}, s_{in_{iv}}, \eta_i, \sigma \in L_2$ , which implies that  $\tilde{u}_b \in L_2^2$ . Since  $\sigma = u - z$  is bounded, and considering (25), (30), (37), and the definition of  $e_{ia}$ , we can say that  $\dot{e}_{ia} + K_{1a} e_{ia}$  is bounded, which can be rewritten as  $\dot{e}_{ia} \leq -K_{1a} e_{ia} + P$ . Considering  $V_e = (1/2) e_{ia}^T e_{ia}$ , we can obtain

$$\dot{V} \leq -e_{ia}^T (K_{1a} - K_e) e_{ia} + \frac{1}{4} (n_{ia} - k_i) \lambda_{\max}(K_e) \|p\|^2$$

where  $P = [p, \dots, p]^T \in \mathbb{R}^{n_{ia}-k_i}$  is a constant vector,  $p > \|\sigma(t)\| \forall t$ ,  $K_e \in \mathbb{R}^{n_{ia}-k_i \times n_{ia}-k_i}$  is a constant diagonal matrix chosen such that  $\lambda_{\min}(K_{1a} - K_e) > 0$ ,  $\lambda_{\max}(K_e)$  denotes the maximum eigenvalue of  $K_e$ , and  $\lambda_{\min}(K_{1a} - K_e)$  denotes the minimum eigenvalue of  $K_{1a} - K_e$ . From the previous equations, we can conclude that  $e_{ia}$  is bounded. Since  $q_{ia}^{1d}$ , the desired trajectory, is bounded, we can say that  $q_{ia}^1$  and  $\dot{q}_{ia}^1$  are bounded, which implies that  $\zeta_{ia}$  and  $\tilde{u}_{ia}$  are bounded as well. From (61) and (62), we can say that  $d(s_{ij} u_{id1})/dt, \dot{s}_{iv}, \dot{\eta}_i$ , and  $\dot{u}$  are bounded. Thus, from (40), we can say that  $\dot{\nu}$  is bounded and that  $\dot{\sigma}$  is bounded as well. Therefore, from Remark 3.1, we can conclude that  $u_{21}, \dots, u_{26}$  are bounded.

Differentiating  $u_{id1}^l \eta_i$  yields

$$\begin{aligned}
\frac{d}{dt} u_{id1}^l \eta_i & = -k_1 u_{id1}^l s_{i1} + l u_{id1}^{l-1} \dot{u}_{id1}^l \eta_i - k_0 u_{id1}^l \eta_i \\
& \quad - u_{id1}^l \left\{ \sum_{j=2}^{v-1} s_{ij} \zeta_{i(j+1)} - \sum_{j=3}^v s_{ij} \sum_{k=2}^{j-1} \frac{\partial(e_{ik} - s_{ik})}{\partial e_{ik}} \zeta_{i(k+1)} \right\}
\end{aligned}$$

where the first term is uniformly continuous and the other terms tend to zero. Since  $(d/dt)u_{id}^l \eta$  converges to zero [18], therefore,  $s_i$  and  $\dot{s}_i$  converge to zero, and  $\zeta_i \rightarrow \zeta_{id}$  and  $\dot{\zeta}_i \rightarrow \dot{\zeta}_{id}$  as  $t \rightarrow \infty$ .

Substituting the control (44) into the reduced-order dynamics (33) yields

$$J^T \left[ (K_\lambda + 1)e_\lambda + K_I \int_0^t e_\lambda dt \right] = M(\dot{\sigma} + \dot{\nu}) + G + d + C(\nu + \sigma) - L(L^T L)^{-1}(u_1 + u_2). \quad (80)$$

Since  $\dot{\sigma}$ ,  $\sigma$ ,  $\dot{\nu}$ ,  $\nu$ ,  $c_i$ ,  $\alpha_i$ ,  $\dot{\zeta}$ ,  $\gamma_i$ ,  $\Lambda$ , and  $\delta_i$  are all bounded, the right-hand side of (80) is also bounded, i.e.,  $J^T[(K_\lambda + 1)e_\lambda + K_I \int_0^t e_\lambda dt] = \Gamma(\dot{\sigma}, \sigma, \dot{\nu}, \nu, c_i, \alpha_i, \dot{\zeta}, \gamma_i, \Lambda, \delta_i), \Gamma(*) \in L_\infty$ .

Let  $\int_0^t e_\lambda dt = E_\lambda$ , where  $\dot{E}_\lambda = e_\lambda$ . By appropriately choosing  $K_\lambda = \text{diag}[K_{\lambda,i}]$ , where  $K_{\lambda,i} > -1$ , and  $K_I = \text{diag}[K_{I,i}]$ , where  $K_{I,i} > 0$ , to make  $E_i(p) = (1/(K_{\lambda,i} + 1)p + K_{I,i})$ , where  $p = d/dt$ , a strictly proper exponential stable transfer function, it can be concluded that  $\int_0^t e_\lambda dt \in L_\infty$ ,  $e_\lambda \in L_\infty$ , and the size of  $e_\lambda$  can be adjusted by choosing the proper gain matrices  $K_\lambda$  and  $K_I$ .

Since  $\dot{\sigma}$ ,  $\sigma$ ,  $\dot{\nu}$ ,  $\nu$ ,  $c_i$ ,  $\alpha_i$ ,  $\dot{\zeta}$ ,  $\gamma_i$ ,  $\Lambda$ ,  $\delta_i$ ,  $e_\lambda$ , and  $\int_0^t e_\lambda dt$  are all bounded, we can say that  $\tau$  is bounded as well. ■

REFERENCES

[1] O. Khatib, K. Yokoi, K. Chang, D. Ruspini, R. Holmberg, and A. Casal, "Coordination and decentralized cooperation of multiple mobile manipulators," *J. Robot. Syst.*, vol. 13, no. 11, pp. 755–764, Nov. 1996.

[2] T. G. Sugar and V. Kumar, "Control of cooperating mobile manipulators," *IEEE Trans. Robot. Autom.*, vol. 18, no. 1, pp. 94–103, Feb. 2002.

[3] H. G. Tanner, K. J. Kyriakopoulos, and N. J. Krikelis, "Modeling of multiple mobile manipulators handling a common deformable object," *J. Robot. Syst.*, vol. 15, no. 11, pp. 599–623, Nov. 1998.

[4] Y. Yamamoto, Y. Hiyama, and A. Fujita, "Semi-autonomous reconfiguration of wheeled mobile robots in coordination," in *Proc. IEEE Int. Conf. Robot. Autom.*, 2004, pp. 3456–3461.

[5] H. G. Tanner, S. Loizou, and K. J. Kyriakopoulos, "Nonholonomic navigation and control of cooperating mobile manipulators," *IEEE Trans. Robot. Autom.*, vol. 19, no. 1, pp. 53–64, Feb. 2003.

[6] T. L. Huntsberger, A. Trebi-Ollennu, H. Aghazarian, P. S. Schenker, P. Pirjanian, and H. D. Nayar, "Distributed control of multi-robot systems engaged in tightly coupled tasks," *Auton. Robots*, vol. 17, no. 1, pp. 929–5593, Jul. 2004.

[7] Y. Hirata, Y. Kume, T. Sawada, Z. Wang, and K. Kosuge, "Handling of an object by multiple mobile manipulators in coordination based on caster-like dynamics," in *Proc. IEEE Int. Conf. Robot. Autom.*, 2004, vol. 26, pp. 807–812.

[8] S. S. Ge and F. L. Lewis, Eds., *Autonomous Mobile Robots: Sensing, Control, Decision-Making, and Applications*. Boca Raton, FL: CRC Press, 2006.

[9] S. Lin and A. A. Goldenberg, "Neural-network control of mobile manipulators," *IEEE Trans. Neural Netw.*, vol. 12, no. 5, pp. 1121–1133, Sep. 2001.

[10] W. Dong, "On trajectory and force tracking control of constrained mobile manipulators with parameter uncertainty," *Automatica*, vol. 38, no. 9, pp. 1475–1484, Sep. 2002.

[11] P. Dauchez, A. Fournier, and R. Jourdan, "Hybrid control of a two-arm robot for complex tasks," *Robot. Auton. Syst.*, vol. 5, no. 4, pp. 323–332, Dec. 1989.

[12] S. S. Ge, L. Huang, and T. H. Lee, "Model-based and neural-network-based adaptive control of two robotic arms manipulating an object with relative motion," *Int. J. Syst. Sci.*, vol. 32, no. 1, pp. 9–23, Jan. 2001.

[13] G. C. Walsh and L. G. Bushnell, "Stabilization of multiple input chained form control systems," *Syst. Control Lett.*, vol. 25, no. 3, pp. 227–234, Jun. 1995.

[14] C. Samson, "Control of chained systems: Application to path following and time-varying point-stabilization of mobile robots," *IEEE Trans. Autom. Control*, vol. 40, no. 1, pp. 64–77, Jan. 1995.

[15] R. M. Murray and S. S. Sastry, "Nonholonomic motion planning: Steering using sinusoids," *IEEE Trans. Autom. Control*, vol. 38, no. 5, pp. 700–716, May 1993.

[16] W. Leroquais and B. d'Andréa-Novet, "Transformation of the kinematic models of restricted mobility wheeled mobile robots with a single platform into chain forms," in *Proc. 34th Conf. Decision Control*, New Orleans, LA, 1995, pp. 1443–1447.

[17] S. S. Ge, T. H. Lee, and C. J. Harris, *Adaptive Neural Network Control of Robotic Manipulators*. London, U.K.: World Scientific, 1998.

[18] J. Slotine and W. Li, *Applied Nonlinear Control*. Englewood, NJ: Prentice-Hall, 1991.

[19] G. S. Bolmsjo, "Programming robot systems for arc welding in small series production," *Robot. Comput.-Integr. Manuf.*, vol. 5, no. 2/3, pp. 498–510, 1989.

[20] R. Weston, "Robot workplaces," *Microprocess. Microsyst.*, vol. 8, no. 5, pp. 245–248, 1984.

[21] S. Ahmad and S. Luo, "Coordinated motion control of multiple robotic devices for welding and redundancy coordination through constrained optimization in Cartesian space," *IEEE Trans. Robot. Autom.*, vol. 5, no. 4, pp. 409–417, Aug. 1989.

[22] W. Dong, W. Xu, and W. Huo, "Trajectory tracking control of dynamic nonholonomic systems with unknown dynamics," *Int. J. Robust Nonlinear Control*, vol. 9, no. 13, pp. 905–922, Nov. 1999.

[23] M. Oya, C. Y. Su, and R. Katoh, "Robust adaptive motion/force tracking control of uncertain nonholonomic mechanical systems," *IEEE Trans. Robot. Autom.*, vol. 19, no. 1, pp. 175–181, Feb. 2003.

[24] Z. Li, S. S. Ge, and A. Ming, "Adaptive robust motion/force control of holonomic constrained nonholonomic mobile manipulators," *IEEE Trans. Syst., Man, Cybern. B, Cybern.*, vol. 37, no. 3, pp. 607–617, Jun. 2007.



**Zhijun Li** (M'07) received the Dr.Eng. degree in mechatronics from Shanghai Jiao Tong University, Shanghai, China, in 2002.

From 2003 to 2005, he was a Postdoctoral Fellow with the Department of Mechanical Engineering and Intelligent Systems, The University of Electro-Communications, Tokyo, Japan. From 2005 to 2006, he was a Research Fellow with the Department of Electrical and Computer Engineering, National University of Singapore, Singapore, and Nanyang Technological University, Singapore. Currently, he is with

the Department of Automation, Shanghai Jiao Tong University. His research interests include adaptive/robust control, mobile manipulators, nonholonomic systems, etc.



**Pey Yuen Tao** received the B.Eng. degree in electrical and computer engineering from the National University of Singapore, Singapore, in 2004, where he is currently working toward the Ph.D. degree in the Department of Electrical and Computer Engineering, National University of Singapore.

His current research interests include intelligent and adaptive control.



**Shuzhi Sam Ge** (S'90–M'92–SM'00–F'06) received the B.Sc. degree from the Beijing University of Aeronautics and Astronautics, Beijing, China, and the Ph.D. degree and the Diploma of Imperial College from the Imperial College of Science, Technology, and Medicine, University of London, London, U.K.

He is the Director of the Social Robotics Laboratory, Interactive Digital Media Institute, and a Professor with the Department of Electrical and Computer Engineering, National University of Singapore, Singapore. He has authored or coauthored three books entitled *Adaptive Neural Network Control of Robotic Manipulators* (World Scientific, 1998), *Stable Adaptive Neural Network Control* (Kluwer, 2001), and *Switched Linear Systems: Control and Design* (Springer-Verlag, 2005), edited a book entitled *Autonomous Mobile Robots: Sensing, Control, Decision Making and Applications* (Taylor & Francis, 2006), and has over 300 international journal and conference papers. He also serves as an Editor of the *Taylor and Francis Automation and Control Engineering Series*. His current research interests include social robotics, multimedia fusion, adaptive control, and intelligent systems.

Dr. Ge has served/been serving as an Associate Editor for a number of flagship journals including the IEEE TRANSACTIONS ON AUTOMATIC CONTROL, the IEEE TRANSACTIONS ON CONTROL SYSTEMS TECHNOLOGY, the IEEE TRANSACTIONS ON NEURAL NETWORKS, and *Automatica*. He is an elected member of the Board of Governors, IEEE Control Systems Society. He was the recipient of the 1999 National Technology Award, the 2001 University Young Research Award, the 2002 Temasek Young Investigator Award, Singapore, and the 2004 Outstanding Overseas Young Researcher Award from the National Science Foundation, China.



**Martin Adams** (M'93) received the B.A. degree in engineering science in 1988, and the D.Phil. degree, both from the University of Oxford, Oxford, U.K., in 1992.

He continued his research in autonomous robot navigation as a Project Leader and Part-Time Lecturer with the Institute of Robotics, Swiss Federal Institute of Technology (ETH), Zurich, Switzerland. He was a Guest Professor and taught control theory at Buchs University, Switzerland, from 1994 to 1995. From 1996 to 2000, he served as a Senior Research

Scientist in robotics and control, in the field of semiconductor assembly automation, at the European Semiconductor Equipment Centre, Switzerland. He is currently an Associate Professor with the School of Electrical and Electronic Engineering, Nanyang Technological University (NTU), Singapore. He has been a Principle Investigator of various robotics projects at NTU, currently leads a collaborative research project providing autonomous cleaning agents within Singapore's largest theme park, and acts as a Consultant to Singapore Technologies Kinetics on various autonomous robotic applications. He has published many articles in top-ranking robotics journals and conferences, as well as various book chapters and a monograph. He has also been serving as an Associate Editor of a leading international journal. His research interests include sensor data processing for robot navigation, simultaneous localization and mapping, inertial navigation, and sensor fusion.



**Wijerupage Sardha Wijesoma** (M'99) received the B.Sc. degree (Engineering Hons.) in electronics and telecommunication engineering from the University of Moratuwa, Moratuwa, Sri Lanka, in 1983 and the Ph.D. degree in robotics from Cambridge University, Cambridge, U.K., in 1990.

He is an Associate Professor with the School of Electrical and Electronic Engineering, Nanyang Technological University (NTU), Singapore. He is also the Program Director for Mobile Robotics of the Center for Intelligent Machines, NTU. He was previously the Head of the Department of Computer Science and Engineering, University of Moratuwa. His research interests include autonomous land and underwater vehicles, with emphasis on problems related to navigation and perception.

Dr. Wijesoma is a member of the British Computer Society and a Chartered Information Systems Engineer (C. Eng.) of the Engineering Council of the U.K. He is a founding committee member of the IEEE Systems, Man, and Cybernetics Society Chapter, Singapore, and the Secretary of the IEEE Oceanic Engineering Society Chapter, Singapore.