

Lecture Notes in Complex Analysis

Based on lectures by Dr Sheng-Chi Liu

Throughout these notes, \square signifies end proof, \blacktriangle signifies end of example, and \blacksquare marks the end of exercise. The exposition in these notes is based in part on [Con78]. This is also where most exercises are from, and is a good source of further exercises for the intrepid reader.

Table of Contents

Table of Contents	i
Lecture 1 Review of Basic Complex Analysis	1
1.1 Basics	1
1.2 Analytic functions	2
1.3 Cauchy–Riemann equations	3
Lecture 2 Möbius Transformations	5
2.1 Conformal mappings	5
2.2 Möbius transformations	6
Lecture 3 Power Series	10
3.1 Möbius transformations preserve lines and circles	10
3.2 Power series representation of analytic functions	11
Lecture 4 Entire Functions	13
4.1 Properties of analytic and entire functions	13
Lecture 5 Cauchy’s Integral Theorem	18
5.1 Winding numbers	18
5.2 Homotopy	21
Lecture 6 Counting Zeros	21
6.1 Simply connected sets and Simple closed curve	21
6.2 Counting zeros	23
Lecture 7 Singularities	26
7.1 Classifying isolated singularities	26
Lecture 8 Laurent Expansion	29
8.1 Laurent expansion around isolated singularity	29
8.2 Residues	33

Notes by Jakob Streipel. Last updated November 11, 2020.

Lecture 9 The Argument Principle	34
9.1 Residue calculus	34
9.2 The argument principle	35
Lecture 10 Bounds of Analytic Functions	38
10.1 Simple bounds	38
10.2 Automorphisms of the unit disk	40
10.3 Automorphisms of the upper half-plane	42
Lecture 11 Hadamard Three-Lines Theorem	44
11.1 Generalising the maximum modulus principle	44
Lecture 12 Phragmén–Lindelöf Principle	46
12.1 Further generalising the maximum modulus principle	46
Lecture 13 The Space of Analytic Functions	50
13.1 The topology of $C(G, \mathbb{C})$	50
13.2 The space of analytic functions	52
Lecture 14 Compactness in $H(G)$	52
14.1 Compactness in the space of analytic functions	52
14.2 Montel’s theorem	54
Lecture 15 The Space of Meromorphic Functions	56
15.1 The topology of $C(G, \mathbb{C}_\infty)$	56
Lecture 16 Compactness in $M(G)$	58
16.1 Compactness in the space of meromorphic functions	58
Lecture 17 Compactness in $M(G)$, continued	62
17.1 Compactness in the space of meromorphic functions, finalised . .	62
17.2 Riemann mapping theorem	64
Lecture 18 The Riemann Mapping Theorem	64
18.1 Proving the Riemann mapping theorem	64
18.2 Entire functions	68
Lecture 19 Infinite Products	69
19.1 Review of infinite products	69
Lecture 20 Weierstrass Factorisation Theorem	74
20.1 Elementary factors	74
Lecture 21 Rank and Genus	79
21.1 Jensen’s formula	79
21.2 The genus and rank of entire functions	81
Lecture 22 Order	84
22.1 The order of entire functions	84
22.2 Hadamard’s factorisation theorem	85
Lecture 23 Range of Analytic Functions	88

23.1 Proof of Hadamard's factorisation theorem	88
23.2 The range of entire functions	89
23.3 The range of an analytic function	90
Lecture 24 Bloch's and Landau's Constants	92
24.1 Proof of Bloch's theorem	92
24.2 The Little Picard theorem	96
Lecture 25 Toward the Little Picard Theorem	97
25.1 Another lemma	97
Lecture 26 The Little Picard Theorem	98
26.1 Proof of the Little Picard theorem	98
26.2 Schottky's theorem	99
Lecture 27 The Great Picard Theorem	101
27.1 The range of entire functions, revisited	101
27.2 Runge's theorem	104
Lecture 28 Mittag-Leffler's Theorem	105
28.1 Runge's theorem	105
28.2 Mittag-Leffler's theorem	108
Lecture 29 Analytic Continuation	110
29.1 Analytic continuation	110
29.2 Dirichlet series	112
Lecture 30 Perron's Formula	114
30.1 Uniqueness of Dirichlet series	114
30.2 Perron's formula	116
References	119
Index	120

Lecture 1 Review of Basic Complex Analysis

1.1 Basics

Throughout we will denote complex numbers by $z = x + iy$, where $x, y \in \mathbb{R}$ and $i = \sqrt{-1}$. We call $x = \operatorname{Re}(z)$ and $y = \operatorname{Im}(y)$, the *real* and *imaginary* parts of z , respectively. Moreover we call $\bar{z} = x - iy$ the *complex conjugate* of z and $|z| = \sqrt{x^2 + y^2} = |\bar{z}|$ the *absolute value* or *modulus* of z . Note, which occasionally comes in handy, that $|z|^2 = z\bar{z}$.

Also commonplace is to discuss *polar representation* of complex numbers. To this end, let $\theta \in \mathbb{R}$ and define

$$e^{i\theta} := \cos(\theta) + i \sin(\theta).$$

This way $e^{i\theta}$ is a point on the unit circle in the complex plane, and so naturally we can scale this by a real number to reach any point in the plane.

Since the complex plane \mathbb{C} has an absolute value $|\cdot|$, as per above, we also have an induced metric, namely for $z_1, z_2 \in \mathbb{C}$ we define the distance $d(z_1, z_2) = |z_1 - z_2|$. Under this metric (\mathbb{C}, d) is a complete metric space.

We will take a moment to discuss some commonly useful functions on the complex plane. The first suspect we have almost seen above already, namely e^z . If $z = x + iy$, then of course

$$e^z = e^{x+iy} = e^x \cdot e^{iy} = e^x (\cos(y) + i \sin(y)),$$

so $|e^z| = e^x = e^{\operatorname{Re}(z)}$.

Close cousin of the exponential function are the basic trigonometric functions; we would like for $\sin(z)$ and $\cos(z)$ to satisfy $e^z = \cos(z) + i \sin(z)$ (and, correspondingly, $e^{iz} = \cos(z) - i \sin(z)$), and so to that end we define

$$\cos(z) := \frac{e^{iz} + e^{-iz}}{2}$$

and

$$\sin(z) := \frac{e^{iz} - e^{-iz}}{2i}.$$

Another close cousin to the exponential function is the natural logarithm. This, for the first time in our brief exploration, is where things get a little bit hairy. We of course would like for $e^{\log(z)} = z$, since we want \log to be the inverse function of the exponential. Now, writing $z = |z|e^{i\theta}$, where $\theta = \arg(z)$, its argument, we can try to puzzle out what $\log(z)$ should look like, by setting $\log(z) = u + iv$ and studying $e^{\log(z)}$.

Since we then have

$$e^{\log(z)} = e^{u+iv} = e^u \cdot e^{iv},$$

and in turn we want $e^{\log(z)} = z = |z|e^{i\theta}$ we have, comparing sides, $e^u = |z|$, i.e., $u = \log|z|$, and $e^{iv} = e^{i\theta}$. This last one is where it gets hairy: this does not imply $v = \theta$, but more loosely that $v = \theta + k2\pi$ for any $k \in \mathbb{Z}$.

Thus

$$\log(z) := \log|z| + i(\theta + k2\pi)$$

for $k \in \mathbb{Z}$, meaning this right-hand side is not unique, so $\log(z)$ is not well-defined, and hence not a function. To resolve this we need to choose a **branch** of $\log(z)$, by which we mean deciding in what range we let the argument live; so long as it's any open interval of length 2π we are fine. For instance, between 0 and 2π would be fine, as would $-\pi$ to π .

1.2 Analytic functions

Definition 1.2.1 (Complex differentiable). Let $G \subset \mathbb{C}$ be an open set. A function $f: G \rightarrow \mathbb{C}$ is **differentiable** at $z \in G$ if

$$f'(z) := \lim_{h \rightarrow 0} \frac{f(z+h) - f(z)}{h}$$

exists.

Note that, crucially, since h is a complex number, this limit must exist along *all* paths.

Definition 1.2.2 (Analytic function). Let $G \subset \mathbb{C}$ be an open set. A function $f: G \rightarrow \mathbb{C}$ is **analytic** if it is continuously differentiable in G , i.e., $f'(z)$ exists and is continuous for all $z \in G$.

Remark 1.2.3. (i) Every (complex) differentiable function is analytic (so the requirement of *continuously* above is not necessary). This, of course, is *not* true in real analysis. Take, for example,

$$f(x) = \begin{cases} x^2 \sin(\frac{1}{x}), & \text{if } x \neq 0, \\ 0, & \text{if } x = 0. \end{cases}$$

Then $f'(x)$ exists everywhere, but is not continuous at $x = 0$.

(ii) Every analytic function is infinitely differentiable, and has a power series representation. This, again, is *not* true in the real case. Take, say,

$$f(x) = \begin{cases} 0, & \text{if } x \leq 0, \\ e^{-\frac{1}{x^2}}, & \text{if } x > 0. \end{cases}$$

Then $f^{(n)}(0) = 0$ for all $n \in \mathbb{N}$, meaning that the Taylor series centred at $x = 0$ is identically zero, but f is not identically zero near 0, so $f(x)$ has no power series there (or, another way of putting it, the radius of convergence of its power series around $x = 0$ is zero).

Exercise 1.1. Show that $f(z) = |z|^2$ has a derivative only at $z = 0$. ■

Proposition 1.2.4. Suppose that $\sum_{n=0}^{\infty} a_n(z-a)^n$ has radius of convergence $R >$

0. Then $f(z) := \sum_{n=0}^{\infty} a_n(z-a)^n$ is analytic in $|z-a| < R$, and moreover

$$f^{(k)}(z) = \sum_{n=0}^{\infty} n(n-1)\dots(n-k+1)a_n(z-a)^{n-k}$$

for $|z-a| < R$ (meaning that the derivative can be taken termwise), and in addition

$$a_n = \frac{f^{(n)}(a)}{n!}.$$

Example 1.2.5. As expected we have

$$e^z = \sum_{n=0}^{\infty} \frac{z^n}{n!}$$

for all $z \in \mathbb{C}$, i.e., $R = \infty$.

Also as expected,

$$(e^z)' = \sum_{n=1}^{\infty} \frac{nz^n}{n!} = \sum_{n=0}^{\infty} \frac{z^n}{n!} = e^z$$

by reindexing the first sum.

Hence this is analytic. ▲

Example 1.2.6. Similarly, we then get

$$\sin(z) = \frac{e^{iz} - e^{-iz}}{2i} = z - \frac{z^3}{3!} + \frac{z^5}{5!} - \cdots + (-1)^n \frac{z^{2n-1}}{(2n-1)!} + \cdots$$

and

$$\cos(z) = \frac{e^{iz} + e^{-iz}}{2} = 1 - \frac{z^2}{2!} + \frac{z^4}{4!} - \cdots + (-1)^n \frac{z^{2n}}{(2n)!} + \cdots,$$

again with infinite radius of convergence. Differentiating termwise we thus, once again as expected, get $(\sin(z))' = \cos(z)$ and $(\cos(z))' = -\sin(z)$, making the two analytic. ▲

Example 1.2.7. Take a branch of $f(z) = \log(z)$, e.g., $-\pi < \arg(z) < \pi$. Then $f(z)$ is analytic in this branch, and $f'(z) = \frac{1}{z}$. ▲

1.3 Cauchy–Riemann equations

Suppose $f: G \rightarrow \mathbb{C}$ is analytic, and write f as a function of the real and imaginary parts of z , i.e., $f(z) = f(x + iy) = f(x, y) = u(x, y) + iv(x, y)$, where then naturally $u, v: G \rightarrow \mathbb{R}$.

Since f is analytic, the derivative

$$f'(z) = \lim_{h \rightarrow 0} \frac{f(z+h) - f(z)}{h}$$

exists, and so in particular exists along any particular given path. We will compute it along two paths, namely parallel to the real axis and parallel to the imaginary axis. In other words, for $h = \delta \in \mathbb{R}$ and for $h = i\delta$, $\delta \in \mathbb{R}$.

First, then,

$$\begin{aligned} f'(z) &= \lim_{\delta \rightarrow 0} \frac{f(z+\delta) - f(z)}{\delta} \\ &= \lim_{\delta \rightarrow 0} \frac{(u(x+\delta, y) - u(x, y)) + i(v(x+\delta, y) - v(x, y))}{\delta} \\ &= \frac{\partial u}{\partial x}(x, y) + i \frac{\partial v}{\partial x}(x, y). \end{aligned}$$

Similarly, along the imaginary direction,

$$\begin{aligned} f'(z) &= \lim_{\delta \rightarrow 0} \frac{(u(x, y + \delta) - u(x, y)) + i(v(x, y + \delta) - v(x, y))}{i\delta} \\ &= \frac{\partial v}{\partial y}(x, y) - i \frac{\partial u}{\partial y}(x, y). \end{aligned}$$

Since those are equal, we compare real and imaginary parts and see that

$$\begin{cases} \frac{\partial u}{\partial x} = \frac{\partial v}{\partial y} \\ \frac{\partial u}{\partial y} = -\frac{\partial v}{\partial x}, \end{cases}$$

known as the **Cauchy–Riemann equations**, which the real and imaginary parts of an analytic function must therefore satisfy.

Differentiating these relations again, we get

$$\frac{\partial^2 u}{\partial x^2} = \frac{\partial^2 v}{\partial x \partial y}$$

and

$$\frac{\partial^2 u}{\partial y^2} = -\frac{\partial^2 v}{\partial y \partial x}.$$

Taking for granted at the moment that the imaginary parts have continuous partials, so that the second partials in the right-hand sides are equal, we then get

$$\frac{\partial^2 u}{\partial x^2} + \frac{\partial^2 u}{\partial y^2} = 0,$$

i.e., letting $\Delta = \frac{\partial^2}{\partial x^2} + \frac{\partial^2}{\partial y^2}$, the **Laplace operator**, we have $\Delta u = 0$, meaning that u is **harmonic**. Taking the opposite partials we can draw the same conclusion about v .

Theorem 1.3.1. *Let u and v be real-valued functions defined on an open set $G \subset \mathbb{C}$. Suppose u and v have continuous partial derivatives. Then $f(z) := u(z) + iv(z)$ is analytic if and only if u and v satisfy the Cauchy–Riemann equations.*

Remark 1.3.2. The function v above is called a **harmonic conjugate** of u .

Proof sketch. Use the Cauchy–Riemann equations to show that the derivative of $f(z) = u(z) + iv(z)$ exists. The converse direction we proved by the previous discussion. \square

Theorem 1.3.3. *Let $G \subset \mathbb{C}$ be a simply connected open set. If $u: G \rightarrow \mathbb{C}$ is a harmonic function, then u has a harmonic conjugate, i.e., there exists a $v: G \rightarrow \mathbb{C}$ such that $f = u + iv$ is analytic.*

Proof sketch. Assume G is a ball, say $G = B(0, R)$. We need to find v such that u and v satisfy the Cauchy–Riemann equations. In other words, we first need $\frac{\partial v}{\partial y} = \frac{\partial u}{\partial x}$. Defining

$$v(x, y) = \int_0^y \frac{\partial u}{\partial x}(x, t) dt + \varphi(x)$$

does the job, since u is given. Now using the second equation, $\frac{\partial v}{\partial x} = -\frac{\partial u}{\partial y}$, we can solve for $\varphi(x)$, namely

$$\frac{\partial v}{\partial x} = \int_0^y \frac{\partial^2 u}{\partial x^2}(x, t) dt + \varphi'(x).$$

Since u is harmonic, we can rewrite this as

$$\int_0^y -\frac{\partial^2 u}{\partial y^2}(x, t) dt + \varphi'(x) = -\frac{\partial u}{\partial y}(x, y) + \frac{\partial u}{\partial y}(x, 0) + \varphi'(x).$$

On the other hand, by the second Cauchy–Riemann equation, this equals

$$-\frac{\partial u}{\partial y}(x, y),$$

whence

$$\varphi'(x) = \frac{\partial u}{\partial y}(x, 0),$$

implying

$$v(x, y) = \int_0^y \frac{\partial u}{\partial x}(x, t) dt + \int_0^x \frac{\partial u}{\partial y}(s, 0) ds.$$

Of course if G isn't a ball we might not be able to integrate along quite this path, but similar arguments work. \square

Exercise 1.2. Let G be an open subset of \mathbb{C} . Define $\bar{G} = \{z \mid \bar{z} \in G\}$. Suppose that $f: G \rightarrow \mathbb{C}$ is analytic. Show that $f^*: \bar{G} \rightarrow \mathbb{C}$ defined by $f^*(z) = \overline{f(\bar{z})}$ is also analytic. \blacksquare

Lecture 2 Möbius Transformations

2.1 Conformal mappings

Let $f: G \rightarrow \mathbb{C}$ be some function and let $z_0 \in G$. Imagine any two (differentiable) curves γ_1 and γ_2 going through z_0 . At the point z_0 these curves have tangent lines, and we can measure the (anticlockwise) angle between the two, say θ .

Now imagine mapping γ_1 and γ_2 through f , resulting in two new curves $f(\gamma_1)$ and $f(\gamma_2)$ going through a point $f(z_0)$. As before, we can measure the angles between the tangent lines of the two curves at this point, say α .

In the event that $\theta = \alpha$ we say that f **preserves angles** at z_0 .

Definition 2.1.1 (Conformal mapping). A function $f: G \rightarrow C$ is a **conformal mapping** if it preserves angles at each point $z_0 \in G$.

Theorem 2.1.2. Let $f: G \rightarrow \mathbb{C}$ be analytic and $z_0 \in G$. Suppose $f'(z_0) \neq 0$. Then f preserves angles at z_0 .

Corollary 2.1.3. If $f: G \rightarrow \mathbb{C}$ is analytic and $f'(z) \neq 0$ for all $z \in G$, then f is a conformal mapping.

Proof of Theorem 2.1.2. Take $\gamma: [a, b] \rightarrow G$ with $\gamma(t_0) = z_0$ and $\gamma'(t_0) \neq 0$. Let $\sigma(t) = f(\gamma(t))$, so that $\sigma(t_0) = f(z_0)$.

Then by the chain rule $\sigma'(t) = f'(\gamma(t)) \cdot \gamma'(t)$, so in particular

$$\sigma'(t_0) = f'(z_0) \cdot \gamma'(t_0).$$

Now by assumption and choice both terms in the right-hand side are nonzero, so $\sigma'(t_0) \neq 0$ too.

Looking at the angles, we then get

$$\arg \sigma'(t_0) = \arg f'(z_0) + \arg \gamma'(t_0),$$

meaning that $\arg \sigma'(t_0) - \arg \gamma'(t_0) = \arg f'(z_0)$, which is fixed and independent of γ . Therefore we get the same

$$\arg \sigma'_1(t_0) - \arg \gamma'_1(t_0) = \arg f'(z_0)$$

for another curve γ_1 , and setting those equal and rearranging we see that

$$\arg \gamma'_1(t_0) - \arg \gamma'(t_0) = \arg \sigma'_1(t_0) - \arg \sigma'(t_0)$$

for any two curves γ and γ_1 , the angle between the tangent lines before applying f is equal to the angle between the tangent lines after applying f , so f preserves angles at z_0 . \square

Example 2.1.4. Let $f(z) = z^2$, so that $f'(z) = 2z$, and in particular $f'(0) = 0$: as expected, f does not preserve angles at $z = 0$.

To see this, imagine mapping the real line through f , ending up with the nonnegative real line in the image space. Similarly, the imaginary line mapped through f results in the nonpositive real line in the image space.

The angles between the two axes before mapping through f is $\pi/2$, but the angle afterwards is π . \blacktriangle

Example 2.1.5. Consider $f(z) = e^z$, for which $f'(z) = e^z \neq 0$ for all $z \in \mathbb{C}$, so f is conformal. Keeping in mind that $e^z = e^{x+iy} = e^x e^{iy}$, we see that, for example, the vertical line $x = c$ gets mapped to $e^c e^{iy}$, with c fixed, so in other words the circle of radius e^c centred on the origin

Similarly, the horizontal line $y = \theta$ gets mapped to $e^x e^{i\theta}$ for a fixed angle θ , where e^x takes any value on $(0, \infty)$, so this line gets mapped to the ray from the origin pointing outward at the angle θ .

Of course this ray lies on a radius of the above circle, so their the angles between those curves is $\pi/2$, just like the angle between vertical and horizontal lines. \blacktriangle

2.2 Möbius transformations

Definition 2.2.1 (Möbius transformation). Let a, b, c , and d be complex numbers with $ad - bc \neq 0$. Then the function

$$S(z) := \frac{az + b}{cz + d}$$

is called a *Möbius transformation* or *linear fractional transformation*.

Notice how for any complex number $\lambda \neq 0$,

$$S(z) = \frac{az + b}{cz + d} = \frac{\lambda az + b}{\lambda cz + d} = \frac{(\lambda a)z + (\lambda b)}{(\lambda c)z + (\lambda d)},$$

meaning that we can choose a, b, c , and d such that $ad - bc = 1$ (by just dividing through by whatever the original $ad - bc \neq 0$ is).

This means that we can identify the Möbius transformation S with a matrix

$$\gamma = \begin{pmatrix} a & b \\ c & d \end{pmatrix} \in \mathrm{SL}_2(\mathbb{C}),$$

where by $\mathrm{SL}_2(\mathbb{C})$ we mean the **special linear group** of 2×2 matrices over \mathbb{C} with determinant 1.

There is a small complication: this identification is not unique, since

$$\frac{az + b}{cz + d} = \frac{(-a)z + (-b)}{(-c)z + (-d)},$$

meaning that γ and $-\gamma$ represent the same Möbius transformation. Consequently we should really identify S with a matrix γ in

$$\mathrm{PSL}_2(\mathbb{C}) = \mathrm{SL}_2(\mathbb{C}) / \{+I, -I\},$$

the **projective special linear group** of 2×2 matrices over \mathbb{C} with determinant 1 (where by I we mean the identity matrix).

Correspondingly then we define for

$$\gamma = \begin{pmatrix} a & b \\ c & d \end{pmatrix} \in \mathrm{SL}_2(\mathbb{C})$$

the action

$$\gamma z = \frac{az + b}{cz + d}.$$

This is a group action on \mathbb{C} , meaning that $Iz = z$ for all z and $(\gamma_1 \gamma_2)z = \gamma_1(\gamma_2 z)$ for all $\gamma_1, \gamma_2 \in \mathrm{SL}_2(\mathbb{C})$ and $z \in \mathbb{C}$. This second property is a fairly lengthy but straight-forward computation.

Keeping the second property in mind, since $\mathrm{SL}_2(\mathbb{C})$ is a group, γ has an inverse element (which is precisely its matrix inverse), $(\gamma^{-1} \gamma)z = Iz = z$, meaning that the Möbius transformation S corresponding to γ has an inverse corresponding to γ^{-1} , i.e.

$$S^{-1}(z) = \gamma^{-1} z = \frac{dz - b}{-cz + a}$$

since the determinant of γ is 1.

Notice moreover that since $z = -\frac{d}{c}$ makes the denominator zero, it is sensible to define Möbius transformations not only on \mathbb{C} but on the **Riemann sphere** $\mathbb{C}_\infty = \mathbb{C} \cup \{\infty\}$. on which we have in particular

$$S\left(-\frac{d}{c}\right) = \infty \quad \text{and} \quad S(\infty) = \frac{a}{c}.$$

One (useful) way to visualise the Riemann sphere is as the projection from the pole (which we label ∞) of a sphere centred on the origin of the complex plane onto said plane. An illustration of this is given in Figure 2.2.1.

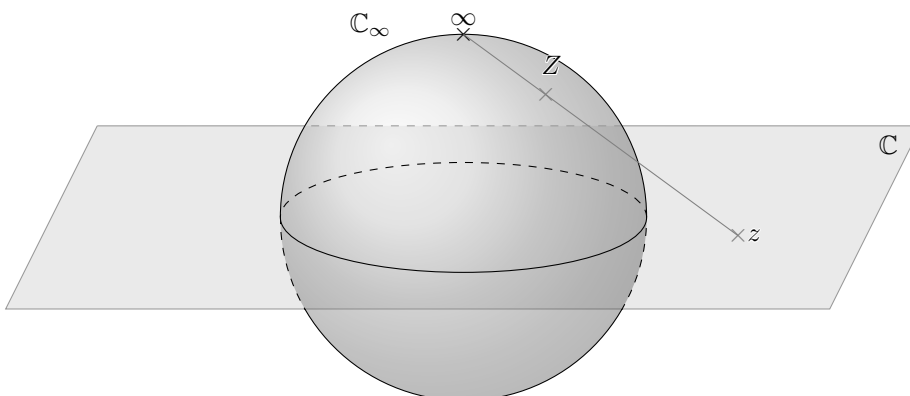

Figure 2.2.1: A model of the Riemann sphere, identifying a point $z \in \mathbb{C}$ with a point Z on \mathbb{C}_∞ .

In this view we see that circles on \mathbb{C}_∞ passing through ∞ correspond to straight lines in \mathbb{C} .

Recalling how

$$S(z) = \frac{az + b}{cz + d}$$

we can see immediately that a Möbius transformation S has at most two fixed points, since $S(z) = z$ becomes $cz^2 + (d - a)z - b = 0$, unless $S = \text{Id}$, i.e., $S(z) = z$ for all $z \in \mathbb{C}_\infty$.

A very useful consequence of this is the fact that $S(z)$ is uniquely determined by its values on any three given points in \mathbb{C}_∞ .

To see this, suppose S and T are Möbius transformations such that $S(z_0) = T(z_0)$, $S(z_1) = T(z_1)$, and $S(z_2) = T(z_2)$ for three distinct points $z_0, z_1, z_2 \in \mathbb{C}_\infty$. Then since T is invertible, we have $T^{-1} \circ S(z_0) = z_0$, $T^{-1} \circ S(z_1) = z_1$, and $T^{-1} \circ S(z_2) = z_2$, meaning that the Möbius transformation $T^{-1} \circ S$ (which is a Möbius transformation by closure of matrix multiplication in $\text{SL}_2(\mathbb{C})$, for the record) has more than two fixed points, meaning that $T^{-1} \circ S = \text{Id}$, and so $S = T$.

As a consequence we have the following

Lemma 2.2.2. *Let $z_2, z_3, z_4 \in \mathbb{C}_\infty$. Then the map*

$$S(z) = \begin{cases} \frac{(z - z_3)(z_2 - z_4)}{(z - z_4)(z_2 - z_3)}, & \text{if } z_2, z_3, z_4 \in \mathbb{C}, \\ \frac{z - z_3}{z - z_4}, & \text{if } z_2 = \infty, \\ \frac{z - z_4}{z_2 - z_4}, & \text{if } z_3 = \infty, \\ \frac{z - z_4}{z - z_3}, & \text{if } z_4 = \infty \end{cases}$$

is the unique Möbius transformation mapping $z_2 \mapsto 1$, $z_3 \mapsto 0$, and $z_4 \mapsto \infty$.

Proof. This is more or less straight-forward construction. If we want $z_4 \mapsto \infty$, we need to have a factor of $z - z_4$ in the denominator but not in the numerator. Similarly, to make $z_3 \mapsto 0$, we must have a $z - z_3$ in the numerator but not the

denominator. Finally for $z_2 \mapsto 1$, we need to make sure we have all the same factors in the numerator and denominator when z is replaced by z_2 , so we need a new $z_2 - z_4$ in the numerator and $z_2 - z_3$ in the denominator.

For the infinity cases, just cancel the relevant infinite factors. \square

We denote this unique map $S(z)$ as (z, z_2, z_3, z_4) , known as the **cross ratio** of z, z_2, z_3 , and z_4 , meaning the Möbius transformation mapping $z_2 \mapsto 1$, $z_3 \mapsto 0$, and $z_4 \mapsto \infty$

Example 2.2.3. This means that for example $(z, 1, 0, \infty) = z$, since a Möbius transformation agreeing with the identity map at three points must agree with it everywhere.

Similarly, $(z_2, z_2, z_3, z_4) = 1$ no matter what z_2, z_3 , and z_4 are. \blacktriangle

Exercise 2.1. Evaluate the following cross ratios:

(a) $(7 + i, 1, 0, \infty)$,

(b) $(2, 1 - i, 1, 1 + i)$,

(c) $(0, 1, i, -1)$,

(d) $(-1 + i, \infty, 1 + i, 0)$. \blacksquare

Proposition 2.2.4. Let $z_2, z_3, z_4 \in \mathbb{C}_\infty$ be three distinct points. Let T be any Möbius transformation. Then

$$(z_1, z_2, z_3, z_4) = (T(z_1), T(z_2), T(z_3), T(z_4))$$

for all $z_1 \in \mathbb{C}_\infty$.

Proof. Let $S(z) = (z, z_2, z_3, z_4)$ and set $M = S \circ T^{-1}$. Then

$$M(T(z_2)) = S \circ T^{-1} \circ T(z_2) = S(z_2) = 1,$$

$M(T(z_3)) = S(z_3) = 0$, and $M(T(z_4)) = S(z_4) = \infty$. Therefore $M = S \circ T^{-1} = S$, and

$$M(z) = (z, T(z_2), T(z_3), T(z_4)).$$

Letting $z_1 = T^{-1}(z)$, so that $T(z_1) = z$, we then get

$$(T(z_1), T(z_2), T(z_3), T(z_4)) = (z_1, z_2, z_3, z_4)$$

for all $z_1 \in \mathbb{C}_\infty$, as desired. \square

Corollary 2.2.5. The unique Möbius transformation $W = T(z)$ mapping z_2, z_3 , and z_4 to w_2, w_3 , and w_4 , respectively, is given by

$$(w, w_2, w_3, w_4) = (z, z_2, z_3, z_4).$$

Exercise 2.2. Find the unique Möbius transformation mapping $z_2 = 1, z_3 = 2, z_4 = 7$ to $w_2 = 1, w_3 = 2, w_4 = 3$, respectively. \blacksquare

Proposition 2.2.6. Let z_1, z_2, z_3 , and z_4 be four distinct points in \mathbb{C}_∞ . then (z_1, z_2, z_3, z_4) is a real number if and only if the four points lie on a circle in \mathbb{C}_∞ .

Exercise 2.3. Let $T(z) = \frac{az + b}{cz + d}$. Show that $T(\mathbb{R}_\infty) = \mathbb{R}_\infty$ if and only if we can choose a, b, c, d to be real numbers. \blacksquare

Lecture 3 Power Series

3.1 Möbius transformations preserve lines and circles

Remember how lines in \mathbb{C} are identified as circles through ∞ on the Riemann sphere. Similarly, circles in \mathbb{C} are circles on \mathbb{C}_∞ .

Let $S(z, z_2, z_3, z_4)$. Then $S^{-1}(\mathbb{R}_\infty) = \{z \in \mathbb{C}_\infty \mid (z, z_2, z_3, z_4) \in \mathbb{R}_\infty\}$, the image of S^{-1} on \mathbb{R}_∞ .

The proposition then follows from the claim that a Möbius transformation maps \mathbb{R}_∞ to a circle in \mathbb{C}_∞ .

Proof. Let $S(z) = \frac{az+b}{cz+d}$, and take $z = x \in \mathbb{R}$, as well as $w = S^{-1}(x) \neq \infty$, i.e., $S(w) = x \in \mathbb{R}$. Then

$$\overline{S(w)} = \frac{\overline{aw+b}}{\overline{cw+d}} = \frac{aw+b}{cw+d} = S(w)$$

since it is real.

Subtracting and doing some algebra then yields

$$(3.1.1) \quad (a\bar{c} - \bar{a}c)|w|^2 + (a\bar{d} - \bar{a}c)w + (\bar{a}d - b\bar{c})\bar{w} + (b\bar{d} - \bar{b}d) = 0.$$

This is essentially a quadratic polynomial in w , unless the leading coefficient is 0, so there are two options. First, if $a\bar{c} \in \mathbb{R}$, meaning that $a\bar{c} - \bar{a}c = 0$. Then setting $\alpha = 2(a\bar{d} - \bar{a}c)$ and $\beta = 2b\bar{d}$, Equation (3.1.1) becomes

$$\text{Im}(\alpha w) + \text{Im}(\beta) = 0,$$

or in other words $\text{Im}(\alpha w + \beta) = 0$. This is a line in \mathbb{C} , and so a circle in \mathbb{C}_∞ (through infinity).

On the other hand if $a\bar{c} \notin \mathbb{R}$, then Equation (3.1.1) becomes

$$|w|^2 + \bar{\gamma}w + \gamma\bar{w} - \delta = 0$$

where

$$\gamma = \frac{\bar{a}d - b\bar{c}}{\bar{a}c - a\bar{c}} \quad \text{and} \quad \delta = \frac{b\bar{d} - \bar{b}d}{\bar{a}c - a\bar{c}}.$$

We then get

$$|w + \gamma| = \left| \frac{ad - bc}{\bar{a}c - a\bar{c}} \right| > 0,$$

so w lies on a circle. □

Theorem 3.1.1. *A Möbius transformation maps circles to circles in \mathbb{C}_∞ .*

Proof. Let Γ be any circle in \mathbb{C}_∞ and let S be a Möbius transformation. Let z_2, z_3 , and z_4 be three distinct points in Γ , and set $w_j = S(z_j)$ for $j = 2, 3, 4$. Then, being three distinct points, w_2, w_3 , and w_4 determine some circle Γ' in \mathbb{C}_∞ .

We need to show that any other point $z \in \Gamma$ then also has the property that $S(z)$ lies on the same circle Γ' , or in other words $S(\Gamma) = \Gamma'$.

But we have, since Möbius transformations preserve cross ratios, that

$$(z, z_2, z_3, z_4) = (S(z), S(z_2), S(z_3), S(z_4)) = (S(z), w_2, w_3, w_4).$$

By Proposition 2.2.6, we have $z \in \Gamma$ if and only if $(z, z_2, z_3, z_4) \in \mathbb{R}$, if and only if $(S(z), w_2, w_3, w_4) \in \mathbb{R}$, if and only if $S(z) \in \Gamma'$. \square

3.2 Power series representation of analytic functions

We will make use of the following calculus result.

Proposition 3.2.1. *Let $\varphi: [a, b] \times [c, d] \rightarrow \mathbb{C}$ be continuous. Define $g: [c, d] \rightarrow \mathbb{C}$ by*

$$g(t) = \int_a^b \varphi(s, t) ds.$$

Then g is continuous, and moreover if $\frac{\partial \varphi}{\partial t}$ exists and is continuous, then $g \in C^1([c, d])$, and

$$g'(t) = \int_a^b \frac{\partial \varphi}{\partial t}(s, t) ds.$$

Lemma 3.2.2. *For $|z| < 1$ we have*

$$\int_0^{2\pi} \frac{e^{is}}{e^{is} - z} ds = 2\pi.$$

Proof. Let $\varphi(s, t) = \frac{e^{is}}{e^{is} - tz}$ for $0 \leq t \leq 1$ and $0 \leq s \leq 2\pi$. Then, because of the size of $|z|$ and the choice of range of t , we are avoiding singularity and have $\varphi \in C^1([0, 2\pi] \times [0, 1])$. Set

$$g(t) = \int_0^{2\pi} \varphi(s, t) ds,$$

so that our goal is to show that $g(1) = 2\pi$.

To this end, first note how $g(0) = 2\pi$, being the integral from 0 to 2π of 1.

We claim that $g'(t)$ is identically 0, which would imply $g(t)$ is constant, and so $g(1) = g(0) = 2\pi$. Fortunately this is easy:

$$\begin{aligned} g'(t) &= \int_0^{2\pi} \frac{e^{is}}{(e^{is} - tz)^2} (-1)(-z) ds = \int_0^{2\pi} \frac{ze^{is}}{(e^{is} - tz)^2} ds \\ &= \frac{-z}{i(e^{is} - tz)} \Big|_{s=0}^{s=2\pi} = 0. \end{aligned} \quad \square$$

Proposition 3.2.3 (Simple version of Cauchy's theorem). *Let G be an open set in \mathbb{C} and let $f: G \rightarrow \mathbb{C}$ be analytic. Suppose $B(a, r) \subset G$ with $r > 0$, and let $\gamma(t) = a + re^{it}$ for $0 \leq t \leq 2\pi$. Then*

$$f(z) = \frac{1}{2\pi i} \int_{\gamma} \frac{f(w)}{w - z} dw$$

for $|z - a| < r$.

Proof. Without loss of generality we may assume $a = 0$ and $r = 1$ (else study $g(z) = f(a + rz)$). Fix z with $|z| < 1$. We need to show that

$$f(z) = \frac{1}{2\pi i} \int_{\gamma} \frac{f(w)}{w - z} dw = \frac{1}{2\pi} \int_0^{2\pi} \frac{f(e^{is})e^{is}}{e^{is} - z} ds,$$

where in the last integral we have parametrised by $w = 1 \cdot e^{is}$ and $dw = ie^{is} ds$. Subtracting $f(z)$, this is equivalent to

$$\int_0^{2\pi} \left(\frac{f(e^{is})e^{is}}{e^{is} - z} - f(z) \right) ds = 0.$$

In view of our previous proposition, let

$$\varphi(s, t) = \frac{f(z + t(e^{is} - z))e^{is}}{e^{is} - z} - f(z)$$

for $0 \leq t \leq 1$ and $0 \leq s \leq 2\pi$. Again it is the case $t = 1$ we are interested in.

Note that since $|z| < 1$, $|z + t(e^{is} - z)| = |(1 - t)z + te^{is}| \leq 1$, meaning that $\varphi \in C^1([0, 2\pi] \times [0, 1])$. Again let

$$g(t) = \int_0^{2\pi} \varphi(s, t) ds,$$

and notice how

$$g(0) = \int_0^{2\pi} \left(\frac{f(z)e^{is}}{e^{is} - z} - f(z) \right) ds = f(z) \int_0^{2\pi} \frac{e^{is}}{e^{is} - z} ds - 2\pi f(z) = 0$$

by the Lemma.

We claim that $g'(t) = 0$ for all $0 \leq t \leq 1$, and again it is a quick computation:

$$\begin{aligned} g'(t) &= \int_0^{2\pi} \frac{\partial \varphi}{\partial t}(s, t) ds = \int_0^{2\pi} f'(z + t(e^{is} - z))(e^{is} - z) \frac{e^{is}}{e^{is} - z} - 0 ds \\ &= \frac{f(z + t(e^{is} - z))}{it} \Big|_{s=0}^{s=2\pi} = 0. \end{aligned}$$

Hence $g(t)$ is constant, and so $g(1) = g(0) = 0$, as desired. \square

Exercise 3.1. Evaluate $\int_{\gamma} \frac{e^{iz}}{z^2} dz$, where $\gamma(t) = e^{it}$, $0 \leq t \leq 2\pi$. \blacksquare

Exercise 3.2. Evaluate $\int_{\gamma} \frac{z^2 + 1}{z(z^2 + 4)} dz$, where $\gamma(t) = re^{it}$, $0 \leq t \leq 2\pi$, for all possible values of $0 < r < 2$ and $2 < r < \infty$. \blacksquare

Theorem 3.2.4 (Power series representation of analytic functions). *Let f be analytic in $B(a, R)$, $R > 0$. Then*

$$f(z) = \sum_{n=0}^{\infty} a_n(z - a)^n$$

for $|z - a| < R$, where

$$a_n = \frac{f^{(n)}(a)}{n!}.$$

Proof. Let $0 < r < R$, and set $\gamma(t) = a + re^{it}$, $0 \leq t \leq 2\pi$. For $w \in \gamma$ and $|z - a| < r$, we have, for $M = \max_{w \in \gamma} |f(w)|$ (which exists since γ is a compact set)

$$\frac{|f(w)||z - a|^n}{|w - a|^{n+1}} \leq \frac{M|z - a|^n}{r^{n+1}} = \frac{M}{r} \left(\frac{|z - a|}{r} \right)^n,$$

where the parenthesis at the end is less than 1 and so term goes to 0 exponentially. Hence

$$\sum_{n=0}^{\infty} \frac{f(w)(z - a)^n}{(w - a)^{n+1}}$$

converges uniformly for $w \in \gamma$, $|z - a| < r$.

But on the other hand, this sum is a geometric series in n , specifically

$$\sum_{n=0}^{\infty} \frac{f(w)(z - a)^n}{(w - a)^{n+1}} = \frac{f(w)}{w - a} \frac{1}{1 - \frac{z - a}{w - a}} = \frac{f(w)}{w - z}.$$

By Cauchy's formula, we then have

$$f(z) = \frac{1}{2\pi i} \int_{\gamma} \frac{f(w)}{w - z} dw = \frac{1}{2\pi i} \int_{\gamma} \sum_{n=0}^{\infty} \frac{f(w)(z - a)^n}{(w - a)^{n+1}} dw.$$

Since the series is uniformly continuous, we can switch the order of summation and integration, giving us

$$f(z) = \sum_{n=0}^{\infty} \left(\frac{1}{2\pi i} \int_{\gamma} \frac{f(w)}{w - a}^{n+1} dw \right) (z - a)^n,$$

meaning that $f(z)$ has a power series representation. \square

Lecture 4 Entire Functions

4.1 Properties of analytic and entire functions

Let us first establish the following corollary to the theorem at the end of last lecture.

Corollary 4.1.1. *Let $G \subset \mathbb{C}$ be open. If $f: G \rightarrow \mathbb{C}$ is analytic, then*

- (i) f is infinitely differentiable;
- (ii) $f^{(n)}(a) = \frac{n!}{2\pi i} \int_{\gamma} \frac{f(w)}{(w - a)^{n+1}} dw$ where $\gamma(t) = a + re^{it}$ for $0 \leq t \leq 2\pi$, and $\gamma \subset G$; and
- (iii) $f(z) = \frac{1}{2\pi} \int_0^{2\pi} f(z + re^{it}) dt$, i.e., the mean value of an analytic function on a circle is the value at the central point.

Proof. The first two properties follow directly from the calculation at the end, noting that the integral in the last equality must be the coefficients from the Taylor expansion (since Taylor's theorem guarantees uniqueness).

For the last property, note that when evaluating

$$f(z) = \frac{1}{2\pi i} \int_{\gamma} \frac{f(w)}{w-z} dw$$

over $w = \gamma(t) = z + re^{it}$ for $0 \leq t \leq 2\pi$, noting that $dw = ire^{it} dt$, we get

$$f(z) = \frac{1}{2\pi i} \int_0^{2\pi} \frac{f(z + re^{it})}{z + re^{it} - z} ire^{it} dt = \frac{1}{2\pi} \int_0^{2\pi} f(z + re^{it}) dt. \quad \square$$

Corollary 4.1.2. *Let f be analytic in $B(a, R)$. Suppose $|f(z)| \leq M$ for every $z \in B(a, R)$. Then*

$$|f^{(n)}(a)| \leq \frac{n!M}{R^n}.$$

Proof. Using (ii) from the previous corollary, we have

$$|f^{(n)}(a)| = \left| \frac{n!}{2\pi i} \int_{\gamma} \frac{f(w)}{(w-a)^{n+1}} dw \right| \leq \frac{n!}{2\pi} \int_{\gamma} \frac{M}{r^{n+1}} |dw|$$

for $0 < r < R$. Evaluating this we get

$$\frac{n!}{2\pi} \frac{M}{r^{n+1}} \cdot 2\pi r = \frac{n!M}{r^n} \rightarrow \frac{n!M}{R^n}$$

as we let r tend to R . □

Theorem 4.1.3. *Let f be analytic in $B(a, R)$. Suppose γ is a closed rectifiable¹ curve in $B(a, R)$. Then f has a primitive and thus $\int_{\gamma} f(z) dz = 0$.*

Proof. Since f is analytic, it has a series representation

$$f(z) = \sum_{n=0}^{\infty} a_n (z-a)^n.$$

Since this series converges uniformly on compact sets, we can integrate termwise, getting

$$F(z) = \sum_{n=0}^{\infty} \frac{a_n}{n+1} (z-a)^{n+1},$$

for which $F'(z) = f(z)$ on $B(a, R)$. Therefore, if we say γ is parametrised from $t = 0$ to $t = 1$, we have

$$\int_{\gamma} f(z) dz = F(\gamma(t)) \Big|_{t=0}^{t=1} = 0. \quad \square$$

Definition 4.1.4 (Entire function). A function f is an *entire* function if it is defined and analytic on \mathbb{C} .

¹Meaning of bounded variation.

Proposition 4.1.5. *If f is an entire function, then*

$$f(z) = \sum_{n=0}^{\infty} a_n z^n$$

where

$$a_n = \frac{f^{(n)}(0)}{n!},$$

with infinite radius of convergence.

Proof. By Theorem 3.2.4, f has a power series representation on any ball $B(0, R)$. Let R tend to infinity, and the proposition follows. \square

Exercise 4.1. Let f be an entire function. Suppose there are constants $M, R > 0$ and an integer $n \geq 1$ such that $|f(z)| \leq M|z|^n$ for $|z| > R$. Show that f is a polynomial of degree $\leq n$. \blacksquare

Note how this means that, in some sense, we can think of an entire function as a ‘polynomial of infinite degree’. This raises a natural question: can the theory of polynomials be generalised to entire functions?

For instance, a polynomial (over \mathbb{C}) can be factored as a product over its zeros by the Fundamental theorem of algebra. Is the same true for entire functions? The answer, it turns out, is yes, known as the Weierstrass factorisation theorem.

Another interesting question, which is easier to answer: no non-constant polynomial is bounded. How about entire functions? The same thing holds, it turns out:

Theorem 4.1.6 (Liouville’s theorem). *If f is a bounded entire function, then f is a constant function.*

Proof. Since f is entire, meaning differentiable, it must be continuous. Hence if we can show that $f'(z) = 0$ for all $z \in \mathbb{C}$, f must be constant.

We already have the estimate we need for this. Suppose f is bounded by M , then by Corollary 4.1.2 with $n = 1$,

$$|f'(x)| \leq \frac{M}{R} \rightarrow 0$$

as $R \rightarrow \infty$. \square

As it happens, an important consequence of this is one of the most elegant proofs of the Fundamental theorem of algebra.

Theorem 4.1.7 (Fundamental theorem of algebra). *If $p(z)$ is a non-constant polynomial, then $p(a) = 0$ for some $a \in \mathbb{C}$.*

Proof. Suppose $p(z) \neq 0$ for all $z \in \mathbb{C}$, and let $f(z) = 1/p(z)$. Since the denominator is never zero, $f(z)$ is an entire function.

Moreover, since $p(z)$ is non-constant,

$$\lim_{|z| \rightarrow \infty} |p(z)| = \infty,$$

implying that

$$\lim_{|z| \rightarrow \infty} \frac{1}{|p(z)|} = \lim_{|z| \rightarrow \infty} |f(z)| = 0.$$

Hence $f(z)$ is bounded, and by Liouville's theorem constant. But that implies that $g(z)$ too is constant, which is a contradiction. \square

Corollary 4.1.8. *Let $p(z)$ be a polynomial of degree n . Then*

$$p(z) = c(z - a_1)^{k_1}(z - a_2)^{k_2} \cdots (z - a_m)^{k_m}$$

for some $c \in \mathbb{C}$, $a_1, a_2, \dots, a_m \in \mathbb{C}$, and $k_1 + k_2 + \cdots + k_m = n$.

Theorem 4.1.9. *Let G be a region² in \mathbb{C} . Let $f: G \rightarrow \mathbb{C}$ be analytic. Then the following are equivalent:*

- (i) $f(z) = 0$ for all $z \in G$;
- (ii) there exists some $a \in G$ such that $f^{(n)}(a) = 0$ for all $n \geq 0$; and
- (iii) the zero set

$$Z(f) := \{ z \in G \mid f(z) = 0 \}$$

of f has a limit point in G .

Proof. That (i) implies (ii) and (i) implies (iii) is trivial.

Let us show that (ii) implies (iii). Let $a \in G$ be a limit point of $Z(f)$. Then since f is continuous, $f(a) = 0$, since we can pass the limit inside the function by continuity. Suppose there exists some $n \in \mathbb{N}$ such that $f'(a) = f''(a) = \cdots = f^{(n-1)}(a) = 0$, but $f^{(n)}(a) \neq 0$. Then

$$f(z) = \sum_{k=n}^{\infty} a_k(z - a)^k = (z - a)^n \sum_{k=n}^{\infty} a_k(z - a)^k.$$

Call the series at the end $g(z)$, which is necessarily analytic, being defined in terms of its power series. Hence $g(a) = a_n \neq 0$. Since a is a limit point of $Z(f)$, there exists $z_n \in Z(f)$ such that $z_n \rightarrow a$, $z_n \neq a$, and hence

$$f(z_n) = (z_n - a)^n g(z_n)$$

where the left-hand side is 0 and the first factor of the right-hand side is nonzero, so $g(z_n) = 0$, implying $g(a) = 0$, which is a contradiction.

Finally let us show that (ii) implies (i). To this end, let

$$A = \{ z \in G \mid f^{(n)}(z) = 0 \text{ for all } n \geq 0 \}.$$

By (ii) we know that at least $a \in A$, so $A \neq \emptyset$. If we can show that $A = G$ we are done, since then f as defined locally by its power series anywhere in G is zero there.

Since G is connected, and a connected set is one in which every open and closed subset is either empty or the entire set, we need to show that A is both open and closed, for it is nonempty, and so must then be G .

²Meaning an open and connected set.

First, to show that A is closed, let $b \in \overline{A}$, and take $\{a_k\} \subset A$ with $a_k \rightarrow b$ as $k \rightarrow \infty$. Then $f^{(n)}(a_k) = 0$ for all $n \geq 0$, since $a_k \in A$, and since $f^{(n)}$ is continuous we also have $f^{(n)}(b) = 0$ for all $n \in \mathbb{N}$. Hence $b \in A$ too, so $A = \overline{A}$ is closed.

Second, we need to show that A is open, which is almost trivial: take $a \in A$ and take some $r > 0$ such that $B(a, r) \subset G$. Then since f is analytic, we have a power representation around a ,

$$f(z) = \sum_{n=0}^{\infty} a_n(z-a)^n$$

for all $z \in B(a, r)$, where crucially

$$a_n = \frac{f^{(n)}(a)}{n!} = 0$$

meaning that $f(z) = 0$ for all $z \in B(a, r)$, whence $B(a, r) \subset A$, so A is open. \square

Corollary 4.1.10. *Let f and g be analytic on a region G . Then $f = g$ if and only if $\{z \in G \mid f(z) = g(z)\}$ has a limit point in G .*

Proof. Take $h(z) = f(z) - g(z)$ in the previous theorem. \square

Example 4.1.11. Consider the function

$$f(z) = \cos\left(\frac{1+z}{1-z}\right)$$

on the region $G = \{z \mid |z| < 1\}$. Since the potential singularity is avoided, f is analytic in G , with the zero set

$$Z(f) = \left\{ \frac{\pi n - 2}{\pi n + 2} \mid n > 0 \text{ odd} \right\}.$$

This has a limit point 1, but it is not in G . \blacktriangle

Corollary 4.1.12. *Let $f \neq 0$ be analytic in a region G . Then for each $a \in G$ with $f(a) = 0$, there exists some $n \in \mathbb{N}$ and some analytic function $g: G \rightarrow \mathbb{C}$ such that*

$$f(z) = (z-a)^n g(z)$$

with $g(a) \neq 0$. In other words, each zero of f has finite order.

Proof. A zero a being of order n means that $f^{(k)}(a) = 0$ for all $k < n$, so the power series representation of f around a starts at $(z-a)^n$, meaning that we can factor out $(z-a)^n$. \square

Corollary 4.1.13. *Let G be a region and let $f: G \rightarrow \mathbb{C}$ be analytic, $f \neq 0$ and $f(a) = 0$ for some $a \in G$. Then there exists some $R > 0$ such that $B(a, R) \subset G$ and $f(z) \neq 0$ for all $0 < |z-a| < R$. That is to say, zeros of an analytic function (not identically zero) are isolated.*

Proof. This is Theorem 4.1.9. \square

Exercise 4.2. Let G be a region. Let f and g be analytic functions on G such that $f(z)g(z) = 0$ for all $z \in G$. Show that either $f \equiv 0$ or $g \equiv 0$. ■

Theorem 4.1.14 (Maximum modulus principle). *Let G be a region and let $f: G \rightarrow \mathbb{C}$ be analytic. Suppose there exists some $a \in G$ such that $|f(a)| \geq |f(z)|$ for all $z \in G$. Then f is constant.*

Proof. Take $\overline{B(a, R)} \subset G$. Then

$$f(a) = \frac{1}{2\pi} \int_0^{2\pi} f(a + re^{it}) dt$$

for $r < R$. Hence

$$|f(a)| \leq \left| \frac{1}{2\pi} \int_0^{2\pi} f(a + re^{it}) dt \right| \leq \frac{1}{2\pi} \int_0^{2\pi} |f(a + re^{it})| dt,$$

but by assumption $|f(a + re^{it})| \leq |f(a)|$, so this is bounded by

$$\frac{1}{2\pi} \int_0^{2\pi} |f(a)| dt = |f(a)|.$$

Hence

$$\left| \frac{1}{2\pi} \int_0^{2\pi} f(a + re^{it}) dt \right| = |f(a)| = \frac{1}{2\pi} \int_0^{2\pi} |f(a)| dt,$$

so rearranging

$$\frac{1}{2\pi} \int_0^{2\pi} |f(a)| - |f(a + re^{it})| dt = 0.$$

Again by assumption this integrand must be nonnegative, but if the integral of a nonnegative continuous function is zero, the function must be zero, so $|f(a)| = |f(a + re^{it})|$ for all $0 \leq t \leq 2\pi$, implying too that $|f(z)| = |f(a)|$ for all $z \in B(a, R)$. Finally this implies that $f(z)$ is constant on $B(a, R)$, since f is continuous, meaning that $f(z)$ is constant also in G . □

Exercise 4.3. Show the last part of the above proof. In other words: Let f be analytic on a region G . Suppose $|f(z)|$ is a constant on G . Show that $f(z)$ is a constant. ■

Lecture 5 Cauchy's Integral Theorem

5.1 Winding numbers

Let $\gamma_1(t) = a + re^{it}$ for $0 \leq t \leq 2\pi$, i.e., the anticlockwise circle of radius r around a . Then

$$\frac{1}{2\pi i} \int_{\gamma_1} \frac{1}{z - a} dz = \frac{1}{2\pi i} \int_0^{2\pi} \frac{ire^{it}}{a + re^{it} - a} dt = \frac{1}{2\pi} \int_0^{2\pi} dt = 1.$$

On the other hand, for b outside the region enclosed by γ_1 , we get

$$\frac{1}{2\pi i} \int_{\gamma_1} \frac{1}{z-b} dz = 0,$$

since the integrand is analytic on the region enclosed by γ_1 .

Similarly, consider another curve $\gamma_2(t) = a + re^{it}$, but this time for $0 \leq t \leq 4\pi$. Then

$$\frac{1}{2\pi i} \int_{\gamma_2} \frac{1}{z-a} dz = 2.$$

So it appears, in general, as though this kind of integral counts how many times the curve goes around a . Indeed this is the case, and first let us make sure it counts in a reasonable way:

Proposition 5.1.1. *If $\gamma: [0, 1] \rightarrow \mathbb{C}$ is a closed rectifiable curve and $a \notin \{\gamma\}$. Then*

$$\frac{1}{2\pi i} \int_{\gamma} \frac{1}{z-a} dz$$

is an integer.

Proof. We may assume that γ is a smooth curve (otherwise approximate it by a smooth curve). Define the function

$$g(t) = \int_0^t \frac{\gamma'(s)}{\gamma(s)-a} ds,$$

so that $g(0) = 0$ and

$$g(1) = \int_{\gamma} \frac{1}{z-a} dz.$$

The strategy is this: since $e^{2\pi ik} = 1$ for all integers k , we want to show that something like $e^{g(t)}$ is constant. To this end, note how by the Fundamental theorem of calculus

$$g'(t) = \frac{\gamma'(t)}{\gamma(t)-a},$$

and notice how

$$\frac{d}{dt} \left(e^{-g(t)} (\gamma(t) - a) \right) = e^{-g(t)} \gamma'(t) - g'(t) e^{-g(t)} (\gamma(t) - a) = 0.$$

Hence $e^{-g(t)} (\gamma(t) - a) = e^{-g(0)} (\gamma(0) - a) = \gamma(0) - a$ is a constant, since $g(0) = 0$. But γ is a closed curve, so $\gamma(0) = \gamma(1)$, meaning that

$$e^{-g(1)} (\gamma(1) - a) = \gamma(0) - a,$$

meaning that $e^{-g(1)} = 1$, so $g(1) = 2\pi ik$ for some integer k . \square

Consequently we make the following definition.

Definition 5.1.2 (Winding number). If γ is a closed rectifiable curve in \mathbb{C} , then for $a \notin \{\gamma\}$,

$$n(\gamma; a) := \frac{1}{2\pi i} \int_{\gamma} \frac{1}{z-a} dz \in \mathbb{Z}$$

is called the **winding number** of γ around a . This simply counts how many times the curve γ winds around a , as suggested by the name.

Example 5.1.3. If a belongs to the unbounded component of $\mathbb{C} \setminus \{\gamma\}$ for some closed rectifiable curve γ , then of course $n(\gamma; a) = 0$, since $\frac{1}{z-a}$ is analytic there. \blacktriangle

Theorem 5.1.4 (Cauchy's integral formula). *Let G be an open set and $f: G \rightarrow \mathbb{C}$ be analytic. Suppose γ is a closed rectifiable curve in G such that $n(\gamma; w) = 0$ for all $w \in \mathbb{C} \setminus G$. Then for $a \in G \setminus \{\gamma\}$,*

$$n(\gamma; a)f(a) = \frac{1}{2\pi i} \int_{\gamma} \frac{f(z)}{z-a} dz.$$

Remark 5.1.5. The condition $n(\gamma; w) = 0$ for all $w \in \mathbb{C} \setminus G$ is to avoid cases where, for instance, G is an annulus and with w in the inside the inner disk and γ around it.

Often in practice we use this theorem for simply connected G , where this is not a problem.

Corollary 5.1.6. *Let G be an open set and $f: G \rightarrow \mathbb{C}$ be analytic. Suppose γ is a closed and rectifiable curve in G such that $n(\gamma; w) = 0$ for all $w \in \mathbb{C} \setminus G$. Then for $a \in G \setminus \{\gamma\}$,*

$$n(\gamma; a)f^{(k)}(a) = \frac{k!}{2\pi i} \int_{\gamma} \frac{f(z)}{(z-a)^{k+1}} dz.$$

Corollary 5.1.7 (Cauchy's theorem). *Let G be an open set and $f: G \rightarrow \mathbb{C}$ an analytic function. Suppose γ is a closed and rectifiable curve in G such that $n(\gamma; w) = 0$ for all $w \in \mathbb{C} \setminus G$. Then*

$$\int_{\gamma} f(z) dz = 0.$$

Proof. Replace $f(z)$ by $f(z)(z-a)$ in Cauchy's integral formula, making the left-hand side 0 and the right-hand side the above integral. \square

It is useful to note that all of these, along with Cauchy's residue theorem (which we might talk about in future) are equivalent.

An interesting question one might naturally ask is if there are other functions that satisfy

$$\int_{\gamma} f(z) dz = 0$$

for all closed curves γ . The answer is no:

Theorem 5.1.8 (Morera's theorem). *Let G be a region and let $f: G \rightarrow \mathbb{C}$ be continuous such that*

$$\int_T f(z) = 0$$

for all triangular paths T in G .³ Then f is analytic in G .

³By triangular path we mean simply a curve composed of three line segments meeting end on end.

Proof. We will show that f has a primitive F , i.e., $F'(z) = f(z)$ in G . This implies that F and f are both analytic, since one derivative implies infinite derivatives in \mathbb{C} .

Without loss of generality we may assume that $G = B(a, R)$, since if we can make the theorem work on any small ball in G , then we can make it work in all of G .

For $z \in G$, define

$$F(z) = \int_{[a,z]} f(z) dz,$$

where by $[a, z]$ we mean the line segment joining a and z , with that orientation. Then for any $z_0 \in G$ we have

$$F(z) = \int_{[a,z]} f(z) dz = \int_{[a,z_0]} f(z) dz + \int_{[z_0,z]} f(z) dz$$

since the interval over all three segments added together is 0 by hypothesis. Therefore

$$\frac{F(z) - F(z_0)}{z - z_0} = \frac{\int_{[z_0,z]} f(z) dz}{z - z_0}.$$

We expect this to be $f(z_0)$, so we study the difference

$$\left| \frac{F(z) - F(z_0)}{z - z_0} - f(z_0) \right| = \left| \frac{1}{z - z_0} \int_{[z_0,z]} (f(w) - f(z_0)) dw \right|.$$

We can bound the integrand by its supremum on $[z_0, z]$, so this is bounded by

$$\frac{1}{|z - z_0|} \int_{[z_0,z]} \sup_{w \in [z_0,z]} |f(w) - f(z_0)| dw = \sup_{w \in [z_0,z]} |f(w) - f(z_0)|$$

since the integrand no longer depends on w . Taking the limit as $z \rightarrow z_0$, this goes to 0 since f is continuous, and hence $F'(z_0) = f(z_0)$ for every $z_0 \in G$. \square

5.2 Homotopy

Definition 5.2.1 (Homotopic). We say that two curves γ_1 and γ_2 are **homotopic** in a domain G if they can be continuously deformed from one to the other inside of the domain.

Definition 5.2.2 (Simply connected). We say that a set G is **simply connected** if every closed curve γ in G is homotopic to a point, denoted $\gamma \simeq 0$.

Lecture 6 Counting Zeros

6.1 Simply connected sets and Simple closed curve

Proposition 6.1.1 (Independence of path). *Let γ_0 and γ_1 be two rectifiable curves in an open set G , both from a to b , and suppose $\gamma_0 \simeq \gamma_1$. Then*

$$\int_{\gamma_0} f(z) dz = \int_{\gamma_1} f(z) dz$$

for any analytic function f on G .

Date: September 5th, 2019.

Proof. Consider the path $\gamma_0 \cup -\gamma_1$, which is then a closed path from a to itself. Then

$$0 = \int_{\gamma_0 \cup -\gamma_1} f(z) dz = \int_{\gamma_0} f(z) dz - \int_{\gamma_1} f(z) dz. \quad \square$$

Corollary 6.1.2. *Let G be simply connected and let $f: G \rightarrow \mathbb{C}$ be analytic. Then f has a primitive.*

Proof. We use the method from our proof of Morera's theorem: since G is simply connected, and f is analytic, the integral of f over any simple closed curve is 0. So in particular the integral of f over any triangular path is 0, so we can construct a primitive of f in the same way we did for Morera's theorem. \square

Corollary 6.1.3. *Let G be simply connected and $f: G \rightarrow \mathbb{C}$ be an analytic function. Suppose $f(z) \neq 0$ for all $z \in G$. Then there exists an analytic function $g: G \rightarrow \mathbb{C}$ such that $f(z) = \exp(g(z))$. Moreover, for fixed $z_0 \in G$ and $f(z_0) = e^{w_0}$, we can choose g such that $g(z_0) = w_0$.*

Before we go on to prove this, let us briefly discuss the idea behind this result. If we have a nonzero thing in \mathbb{R} , we can take its logarithm. The same thing is not *quite* true in \mathbb{C} , because the complex logarithm is not analytic—it requires a branch cut, but it does make sense to take logarithms *locally*, just make sure the branch cut doesn't interfere in the local neighbourhood at hand.

Hence, since we can't take logarithms globally, we instead express a sort of inverse of the result, hence the exponential function.

Proof. Since $f(z) \neq 0$ for all $z \in G$ and f' exists since f is analytic, we must have that its logarithmic derivative $\frac{f'}{f}(z)$ is analytic in G .

Hence by Corollary 6.1.2 $\frac{f'}{f}(z)$ has a primitive, say g_1 . Setting $h(z) = \exp(g_1(z))$, this must be analytic in G and moreover because of the exponential $h(z) \neq 0$ for all $z \in G$. Thus $\frac{f}{h}$ is analytic in G , and computing its derivative we get

$$\left(\frac{f}{h}\right)' = \frac{f'h - fh'}{h^2} = \frac{f'e^{g_1} - fe^{g_1}g_1'}{h^2} = \frac{f'e^{g_1} - fe^{g_1}\frac{f'}{f}}{h^2} = 0.$$

Therefore $\frac{f}{h}$ is constant, so, say, $f = c \cdot h$ for some $c \neq 0$. But then

$$f(z) = c \exp(g_1(z)) = \exp(g(z))$$

for some scaled version $g(z)$ of $g_1(z)$.

Note finally how, since the exponential is invariant under shifts of $2\pi ik$ for integers k , this is equal to $\exp(g(z) + 2\pi ik)$ for all integers k , and so if we want

$$f(z_0) = e^{w_0} = \exp(g(z_0) + 2\pi ik),$$

we need just choose k such that $w_0 = g(z_0) + 2\pi k$ and rename g to include this shift. \square

6.2 Counting zeros

Recall how if G is a region and $f: G \rightarrow \mathbb{C}$ is analytic with zeros a_1, a_2, \dots, a_m (repeated according to multiplicities), we can write

$$f(z) = (z - a_1)(z - a_2) \cdots (z - a_m)g(z)$$

where g is analytic in G and $g(z) \neq 0$ for all $z \in G$. Taking the logarithmic derivative of this we get

$$\frac{f'}{f}(z) = \frac{1}{z - a_1} + \frac{1}{z - a_2} + \cdots + \frac{1}{z - a_m} + \frac{g'}{g}(z).$$

Notice how $\frac{g'}{g}$ is analytic in G since g , by construction, is never zero. Hence if we integrate this expression over a closed rectifiable curve $\gamma \simeq 0$, the last term goes away, and importantly, by Cauchy's integral formula, each of the remaining terms will contribute exactly $2\pi i$ times the winding number of γ around them if they are inside the region enclosed by γ , and otherwise zero. Therefore

Theorem 6.2.1. *Let G be a region and let f be an analytic function on G with zeros a_1, a_2, \dots, a_m , repeated according to multiplicities. Let γ be a closed rectifiable curve in G such that $a_i \notin \{\gamma\}$ for any $i = 1, 2, \dots, m$, and $\gamma \simeq 0$ in G . Then*

$$\frac{1}{2\pi i} \int_{\gamma} \frac{f'}{f}(z) dz = \sum_{i=1}^m n(\gamma; a_i).$$

In practice, we often care about a simpler version of this result:

Corollary 6.2.2. *Let G be a region and let γ be a simple closed curve in G . Then the integral*

$$\int_{\gamma} \frac{f'}{f}(z) dz$$

counts the zeros of f enclosed by γ with multiplicities (assuming no zeros of f lie on γ).

Theorem 6.2.3. *Let f be analytic in $B(a, R)$, and let $f(a) = \alpha$. Suppose $f(z) - \alpha$ has a zero of order m at $z = a$. Then there exist $\varepsilon > 0$ and $\delta > 0$ such that for all $0 < |\xi - \alpha| < \delta$, the function $f(z) - \xi$ has exactly m simple roots in $B(a, \varepsilon)$.*

Remark 6.2.4. This theorem implies that $f(B(a, \varepsilon)) \supset B(\alpha, \delta)$. This will be important in just a moment.

Proof. Since the zeros of an analytic function are isolated, we can find $0 < \varepsilon < \frac{R}{2}$ such that $f(z) = \alpha$ has no solutions in $0 < |z - a| < 2\varepsilon$, and $f'(z) \neq 0$ in $0 < |z - a| < 2\varepsilon$. For this second part, note that it is of course possible that f' has a zero near a , but f' is also analytic, and its zeros are also isolated, so in that case shrink the ball some more.

Let $\gamma(t) = a + \varepsilon \exp(2\pi it)$ for $0 \leq t \leq 1$, and let $\sigma = f \circ \gamma$, the image of this circle under f .

Since $\alpha = f(a) \notin \{\sigma\}$, there exists some $\delta > 0$ such that $B(\alpha, \delta) \cap \{\sigma\} = \emptyset$. Hence $B(\alpha, \delta) \subset \mathbb{C} \setminus \{\sigma\}$. Therefore, since both α and ξ are inside the region enclosed by σ ,

$$n(\sigma; \alpha) = \frac{1}{2\pi i} \int_{\sigma} \frac{1}{z - \alpha} dz = \frac{1}{2\pi i} \int_{\sigma} \frac{1}{z - \xi} dz.$$

But $\sigma = f \circ \gamma$, so taking the change of variables $z = f(w) - \alpha$, $dz = (f(w) - \alpha)' dw$ in the first integral, we get

$$\frac{1}{2\pi i} \int_{\gamma} \frac{(f(w) - \alpha)'}{f(w) - \alpha} dw,$$

which is the number of zeros of $f(z) - \alpha$ in $B(a, \varepsilon)$, or in other words m . Doing the same thing to the second integral we get that

$$\frac{1}{2\pi i} \int_{\sigma} \frac{1}{z - \xi} dz$$

is the number of zeros of $f(z) - \xi$ in $B(a, \varepsilon)$, but we chose ε such that $f'(z) \neq 0$ for all $0 < |z - a| < 2\varepsilon$, so each of these roots of $f(z) - \xi$ is simple. \square

The remark, as promised, is fairly important:

Theorem 6.2.5 (Open mapping theorem). *Let G be a region. Suppose f is a non-constant analytic function on G . Then for any open set $U \subset G$, $f(U)$ is open.*

Proof. Let $U \subset G$ be open. We want to show that $f(U)$ is open, i.e., for every $\alpha \in f(U)$ there exists some $\delta > 0$ such that $B(\alpha, \delta) \subset f(U)$.

To this end, suppose $a \in G$ such that $f(a) = \alpha$. By the previous theorem there exists $\varepsilon > 0$ and $\delta > 0$ such that $B(a, \varepsilon) \subset U$ and $f(B(a, \varepsilon)) \supset B(\alpha, \delta)$, and $f(U) \supset f(B(a, \varepsilon))$, so $f(U)$ is open. \square

As an aside, this implies that an injective analytic function has analytic inverse, since it says that preimages of open sets under the inverse are open sets. Though we know more than that about an injective analytic function: its derivative must be nonzero everywhere, so in fact it would be a conformal mapping:

Exercise 6.1. Let G be a region. Suppose that $f: G \rightarrow \mathbb{C}$ is analytic and one-to-one. Show that $f'(z) \neq 0$ for all $z \in G$. \blacksquare

Remark 6.2.6. The converse of this exercise is not true: there exist analytic functions with non-vanishing derivatives that are not one-to-one. An easy example is $f(z) = e^z$; the derivative of this is never zero, but $f(z + 2\pi ik) = f(z)$ for all integers k , so it is certainly not injective.

We mentioned a long time ago, in Remark 1.2.3 (i), that requiring the derivative of a function to be continuous in the definition of analytic is superfluous. We are finally ready to prove this:

Theorem 6.2.7 (Goursat's theorem). *Let G be an open set and let $f: G \rightarrow \mathbb{C}$ be differentiable. Then f is analytic.*

Proof. We want to show, ultimately, that f' is continuous, but it turns out a better idea, by Morera's theorem, is to show that

$$\int_T f(z) dz = 0$$

for all triangular paths T in G , since f , being differentiable, is continuous, and by Morera's theorem this would make it analytic.

Let T be an arbitrary triangular path in G . Then if we form new add and subtract the line segments between the midpoints of the line segments making up T , as per Figure 6.2.1, we have not changed the path, and we have

$$\int_T f(z) dz = \sum_{i=1}^4 \int_{T_i} f(z) dz.$$

Now let T^1 be the triangular path among T_1, T_2, T_3 , and T_4 such that

$$\left| \int_{T^1} f(z) dz \right| = \max_{1 \leq i \leq 4} \left| \int_{T_i} f(z) dz \right|.$$

Then by construction

$$\left| \int_T f(z) dz \right| \leq 4 \left| \int_{T^1} f(z) dz \right|.$$

Repeat this process with T^1 in place of T , getting T^2 , and so on. In general, then, we have

$$\left| \int_{T^n} f(z) dz \right| \leq 4^n \left| \int_{T^1} f(z) dz \right|,$$

the lengths of the paths halve every time, i.e.,

$$\ell(T^n) = \frac{1}{2} \ell(T^{n-1}) = \dots = \frac{1}{2^n} \ell(T),$$

and letting Δ^n denote the closed triangle inside T^n , so that

$$\Delta \supset \Delta^1 \supset \dots \supset \Delta^n,$$

we have

$$\text{diam}(\Delta^n) = \frac{1}{2} \text{diam}(\Delta^{n-1}) = \dots = \frac{1}{2^n} \text{diam}(\Delta),$$

which goes to 0 as $n \rightarrow \infty$. Now the intersection

$$\bigcap_{n=1}^{\infty} \Delta^n$$

is nonempty, since the Δ^n are closed and nested, but the diameter of the intersection goes to 0, so the intersection contains only a single point, say z_0 .

Since f is differentiable at z_0 , we have that for every $\varepsilon > 0$ there exists some $\delta > 0$ such that $B(z_0, \delta) \subset G$ and

$$\left| \frac{f(z) - f(z_0)}{z - z_0} - f'(z_0) \right| < \varepsilon$$

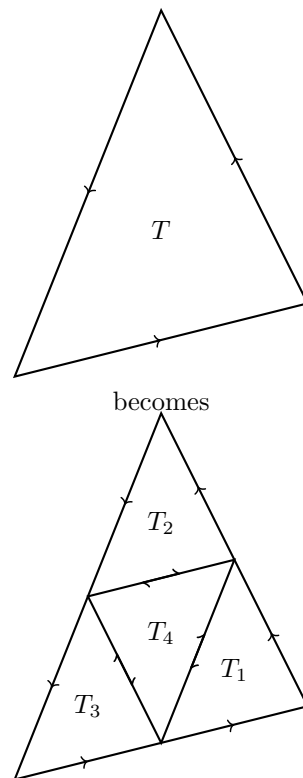

Figure 6.2.1: Decomposing a triangular path T into smaller triangular paths.

for every $0 < |z - z_0| < \delta$. Hence

$$|f(z) - f(z_0) - f'(z_0)(z - z_0)| < \varepsilon|z - z_0|.$$

Now, since the functions 1 and z are analytic, by Cauchy's theorem

$$\int_{T^n} 1 \, dz = \int_{T^n} z \, dz = 0,$$

and thus for n sufficiently large

$$\left| \int_{T^n} f(z) \, dz \right| = \left| \int_{T^n} f(z) - f(z_0) - f'(z_0)(z - z_0) \, dz \right| \leq \varepsilon \int_{T^n} |z - z_0| \, dz.$$

But z is on T^n and z_0 is in the interior of Δ^n , so this distance is bounded by $\text{diam}(\Delta^n)$. Hence the integral is bounded above by

$$\varepsilon \text{diam}(\Delta^n) \ell(T^n) = \frac{\varepsilon}{4^n} \text{diam}(\Delta) \ell(T).$$

Hence

$$\left| \int_T f(z) \, dz \right| \leq 4^n \frac{\varepsilon}{4^n} \text{diam}(\Delta) \ell(T) = \varepsilon \text{diam}(\Delta) \ell(T),$$

but $\varepsilon > 0$ is arbitrary, so

$$\left| \int_T f(z) \, dz \right| = \int_T f(z) \, dz = 0,$$

as desired. □

Lecture 7 Singularities

7.1 Classifying isolated singularities

Definition 7.1.1 (Singularity). A function f has an *isolated singularity* at $z = a$ if there is an $R > 0$ such that f is defined and analytic on $B(a, R) \setminus \{a\}$, but not at $z = a$ itself.

Moreover the point $z = a$ is called a *removable singularity* if there is an analytic function $g: B(a, R) \rightarrow \mathbb{C}$ such that $g(z) = f(z)$ for all $z \in B(a, R) \setminus \{a\}$.

Example 7.1.2. The function $f(z) = \frac{\sin(z)}{z}$, $z \neq 0$, has the limit $\lim_{z \rightarrow 0} f(z) = 1$.

Hence we can define

$$g(z) = \begin{cases} \frac{\sin(z)}{z}, & \text{if } z \neq 0 \\ 1, & \text{if } z = 0, \end{cases}$$

where g is analytic. So f has a removable singularity at $z = 0$. ▲

This is an interesting point about complex analysis: if we have a function that is analytic apart from a single point, and we can fill that point in so that the resulting function is continuous, then the whole function becomes analytic. Compare that with the real case: if we have a differentiable function with a hole, filling that point in does not mean the filled in function is differentiable. For example, consider $f(x) = |x|$, except undefined at 0.

Example 7.1.3. The function $f(z) = \frac{1}{z}$ has an isolated singularity at $z = 0$, but it is not removable, because $\lim_{z \rightarrow 0} |f(z)| = \infty$. ▲

Example 7.1.4. The function $f(z) = \exp(\frac{1}{z})$, $z \neq 0$, is sort of different: this also has an isolated singularity at $z = 0$, but $\lim_{z \rightarrow 0} |f(z)|$ does not exist, even in the sense of infinity. ▲

Of course the natural question that arises is how we would determine, in general, if an isolated singularity is removable or not.

Theorem 7.1.5. Suppose f has an isolated singularity at $z = 0$. Then $z = a$ is a removable singularity if and only if $\lim_{z \rightarrow a} (z - a)f(z) = 0$.

Proof. For the forward direction, assume $z = a$ is a removable singularity of f , i.e., there exists some analytic $g: B(a, R) \rightarrow \mathbb{C}$ such that $f(z) = g(z)$ for all $z \in B(a, R) \setminus \{a\}$. So

$$\lim_{z \rightarrow a} (z - a)f(z) = \lim_{z \rightarrow a} (z - a)g(z) = (a - a)g(a) = 0,$$

where we can replace f by g in the limit since the limit never touches $z = a$, and in the last step we use the fact that both $z - a$ and $g(z)$ are continuous at $z = a$.

For the converse direction, define

$$h(z) = \begin{cases} (z - a)f(z), & \text{if } z \neq a \\ 0, & \text{if } z = a. \end{cases}$$

Since $\lim_{z \rightarrow a} (z - a)f(z) = 0 = h(a)$, h is continuous. Then if we can show that h is analytic, then we are done, since it means that $h(z) = (z - a)g(z)$, g analytic, and so for $z \neq a$ we have $(z - a)f(z) = (z - a)g(z)$, and cancelling $z - a$ we have $f(z) = g(z)$.

Now to prove that h is analytic, it suffices by Morera's theorem to show that $\int_T h(z) dz = 0$ for all triangular paths R in the domain.

There are (sort of) four cases to consider here. Case 1, the point $z = a$ lies outside of T . In that case

$$\int_T h(z) dz = \int_T (z - a)f(z) dz = 0$$

since $(z - a)f(z)$ is analytic inside T .

Case 2, $z = a$ is a vertex of T . Then we can divide T into a quadrilateral path P and a smaller triangular path T_ε , as per Figure 7.1.1. Since h is analytic inside P , we have

$$\int_T h(z) dz = \int_{T_\varepsilon} h(z) dz + \int_P h(z) dz = \int_{T_\varepsilon} h(z) dz.$$

Since h is continuous at $z = a$ and $h(a) = 0$, for every $\varepsilon > 0$ there exists some T_ε small enough such that $|h(z)| < \varepsilon$ for all $z \in T_\varepsilon$. Hence

$$\left| \int_{T_\varepsilon} h(z) dz \right| \leq \int_{T_\varepsilon} |h(z)| dz \leq \int_{T_\varepsilon} \varepsilon = \varepsilon \ell(T_\varepsilon) < \varepsilon,$$

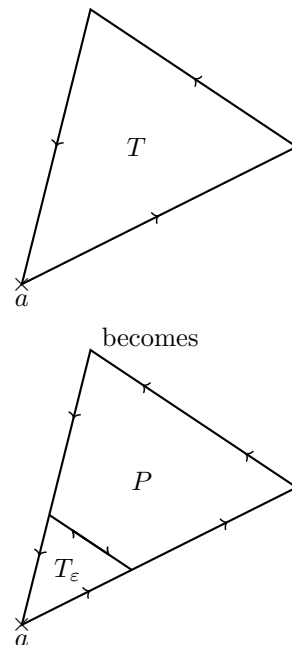

Figure 7.1.1: Decomposing a triangular path T into a smaller triangular path T_ε and a quadrilateral path P .

since we can choose the subdivision so that $\ell(T_\varepsilon) < 1$. Hence $\int_T h(z) dz = 0$.

Case 3, $z = a$ lies inside of T . In this case, split T into three triangular paths by joining the vertices up with $z = a$, see Figure 7.1.2. Then

$$\int_T h(z) dz = \int_{T_1} h(z) dz + \int_{T_2} h(z) dz + \int_{T_3} h(z) dz = 0$$

by the previous case, since a is a vertex for each of the three triangular paths.

Finally case 4, $z = a$ might sit on T but not on a vertex. In this case, we play the same subdivision game, only splitting into two triangular paths, and again $z = a$ is a vertex of each. \square

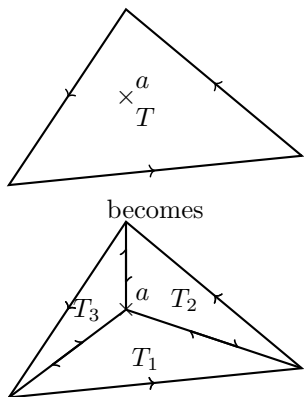

Figure 7.1.2: Dividing a triangular path T into three triangular paths T_1 , T_2 , and T_3 .

Remark 7.1.6. If $f(z)$ has a ‘true’ singularity at $z = a$, i.e., not removable, then $f(z)$ must behave badly near $z = a$, in the sense that $|f(z)| \rightarrow \infty$ as $z \rightarrow a$ or the limit doesn’t exist at all.

Definition 7.1.7 (Pole, essential singularity). Let $z = a$ be an isolated singularity of a function f . We call $z = a$ a **pole** of f if $\lim_{z \rightarrow a} |f(z)| = \infty$.

If $z = a$ is neither a pole nor a removable singularity, then we call $z = a$ an **essential singularity** of f .

Example 7.1.8. The function $f(z) = \frac{1}{(z-a)^m}$, $m \in \mathbb{N}$, has a pole at $z = a$. \blacktriangle

Example 7.1.9. The example discussed previously, $f(z) = \exp(\frac{1}{z})$, has an essential singularity at $z = 0$. \blacktriangle

Proposition 7.1.10. Let G be a region and $a \in G$. Suppose f is analytic on $G \setminus \{a\}$ with a pole at $z = a$. Then there exists some $m \in \mathbb{N}$ and an analytic $g: G \rightarrow \mathbb{C}$ such that

$$f(z) = \frac{g(z)}{(z-a)^m},$$

where $g(a) \neq 0$.

Compare this to how we can factor zeros of multiplicity m out analytic functions.

Remark 7.1.11. We say that f as above has a pole of **order** m at $z = a$.

Proof. Let

$$h(z) = \begin{cases} \frac{1}{f(z)}, & \text{if } z \neq a, \\ 0, & \text{if } z = a. \end{cases}$$

Then $h(z)$ is analytic on a ball $B(a, R)$ for some $R > 0$ since the zeros of f are isolated, and $h(a) = 0$. Hence we can factor

$$h(z) = (z-a)^m h_1(z)$$

for some $m \in \mathbb{N}$ and h_1 analytic on $B(a, R)$ with $h_1(a) \neq 0$. For $z \neq a$ we can therefore write

$$\frac{1}{f(z)} = (z-a)^m h_1(z),$$

and since the h_1 is analytic, its zeros are isolated, so there exists some ball $B(a, r)$, $r \leq R$, such that $h_1(z) \neq 0$ on it. Thus

$$f(z)(z-a)^m = \frac{1}{h_1(z)},$$

for all $z \in B(a, r) \setminus \{a\}$, where the left-hand side is undefined for $z = a$ but the right-hand side is. This means that $z = a$ is a removable singularity of $f(z)(z-a)^m$, and therefore there exist some analytic $g: G \rightarrow \mathbb{C}$ such that $f(z)(z-a)^m = g(z)$ for all $z \neq a$ in G , and so finally

$$f(z) = \frac{g(z)}{(z-a)^m}. \quad \square$$

Note that since this resulting g is analytic, it has a power series expansion

$$g(z) = A_m + A_{m-1}(z-a) + \cdots + A_1(z-a)^{m-1} + (z-a)^m \sum_{k=0}^{\infty} a_k(z-a)^k.$$

Therefore f has a sort of ‘almost’ power series representation

$$f(z) = \frac{A_m}{(z-a)^m} + \frac{A_{m-1}}{(z-a)^{m-1}} + \cdots + \frac{A_1}{z-a} + \sum_{k=0}^{\infty} a_k(z-a)^k,$$

where the infinite series at the end is analytic, and the m terms at the front are not. We will talk more about this representation in the near future.

Lecture 8 Laurent Expansion

8.1 Laurent expansion around isolated singularity

Theorem 8.1.1 (Laurent expansion). *Let f be analytic in the annulus $R_1 < |z-a| < R_2$. Then*

$$f(z) = \sum_{n=-\infty}^{\infty} a_n(z-a)^n$$

where the convergence is absolute, and uniform in compact subsets $r_1 \leq |z-a| \leq r_2$, $R_1 < r_1 < r_2 < R_2$. Moreover

$$a_n = \frac{1}{2\pi i} \int_{\gamma} \frac{f(z)}{(z-a)^{n+1}} dz$$

where γ is a circle $|z-a| = r$ with $R_1 < r < R_2$. Finally, this series representation is unique.

We call this kind of series representation of f its **Laurent expansion** around $z = a$.

Remark 8.1.2. When we say that a series $\sum_{n=-\infty}^{\infty} b_n$ converges (absolutely) we mean that both $\sum_{n=0}^{\infty} b_n$ and $\sum_{n=1}^{\infty} b_{-n}$ converge (absolutely) separately.

Importantly, this is different from the maybe more intuitive interpretation that

$$\lim_{M \rightarrow \infty} \sum_{n=-M}^M b_n$$

should converge, which would allow for cancellation between the negative and positive indices (for instance $b_n = \frac{1}{n}$ and $b_0 = 0$ would be 0 in this sense, but not converge at all in the first sense).

Proof. Without loss of generality we may assume $a = 0$, else just shift. Let $\gamma_1(t) = r_1 e^{2\pi i t}$ and $\gamma_2(t) = r_2 e^{2\pi i t}$, both for $0 \leq t \leq 1$, and $R_1 < r_1 < r_2 < R_2$.

Define a function

$$g(w) = \begin{cases} \frac{f(w) - f(z)}{w - z}, & \text{if } w \neq z \\ f'(z), & \text{if } w = z. \end{cases}$$

This is analytic in $R_1 < |w| < R_2$. If we join the two concentric circles γ_1 and γ_2 by a line segment L and its opposite $-L$, and let $\gamma = \gamma_2 + L - L - \gamma_1$, a closed curve.

Now take z to be inside γ , in other words between the two circles γ_1 and γ_2 (and not on the connecting line L , but we can move that line to never touch z). By Cauchy's theorem,

$$\int_{\gamma} g(w) dw = 0,$$

meaning that

$$\int_{\gamma_2 - \gamma_1} \frac{f(w) - f(z)}{w - z} dw = 0,$$

since the integral along L and $-L$ cancel. Splitting this apart we see that

$$(8.1.1) \quad \int_{\gamma_2 - \gamma_1} \frac{f(w)}{w - z} dw = \int_{\gamma_2 - \gamma_1} \frac{f(z)}{w - z} dw.$$

The second integral is easy to compute piece by piece. On γ_2 , since z lies inside it,

$$\int_{\gamma_2} \frac{f(z)}{w - z} dz = f(z) \int_{\gamma_2} \frac{1}{w - z} dw = 2\pi i f(z),$$

strictly times the winding number $n(\gamma_2; z)$, but that is 1 in this case. Similarly, since z lies outside of γ_1 ,

$$\int_{\gamma_1} \frac{f(z)}{w - z} dw = f(z) \int_{\gamma_1} \frac{1}{w - z} dw = 0.$$

So the right-hand side integral in Equation (8.1.1) above is $2\pi i f(z)$.

Next we wish to compute the left-hand side of same. Note that on γ_2 , $|w| > |z|$ since z lies inside the circle, so we can factor $\frac{1}{w-z}$ as a geometric series,

$$\frac{1}{w - z} = \frac{1}{w} \frac{1}{1 - \frac{z}{w}} = \frac{1}{w} \left(1 + \frac{z}{w} + \frac{z^2}{w^2} + \dots \right) = \frac{1}{w} + \frac{z}{w^2} + \frac{z^2}{w^3} + \dots$$

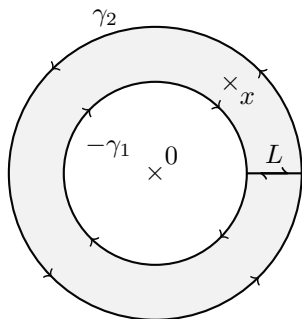

Figure 8.1.1: Joining $-\gamma_1$ and γ by a line and its opposite. Note the reverse orientation on $-\gamma_1$.

Therefore

$$\int_{\gamma_2} \frac{f(w)}{w-z} dw = \int_{\gamma_2} f(w) \sum_{n=0}^{\infty} \frac{z^n}{w^{n+1}} dw = \sum_{n=0}^{\infty} \left(\int_{\gamma_2} \frac{f(w)}{w^{n+1}} dw \right) z^n$$

since the geometric series converges absolutely.

On the other hand, on γ_1 , $|w| < |z|$, so this time

$$\frac{1}{w-z} = \frac{1}{z} \frac{1}{\frac{w}{z} - 1} = -\frac{1}{z} \frac{1}{1 - \frac{w}{z}},$$

which as a geometric series becomes

$$-\left(\frac{1}{z} + \frac{w}{z^2} + \frac{w^2}{z^3} + \dots \right),$$

meaning that

$$\int_{\gamma_1} \frac{f(w)}{w-z} dw = - \int_{\gamma_1} f(w) \sum_{n=-1}^{-\infty} \frac{z^n}{w^{n+1}} dw = - \sum_{n=-\infty}^{-1} \left(\int_{\gamma_1} \frac{f(w)}{w^{n+1}} dw \right) z^n.$$

Now in order to get the kind of series we want we would like to simply combine these two expressions, taking care of the minus sign, and be done, but currently the integrals are over different paths γ_1 and γ_2 . The good news though is that $\gamma_1 \simeq \gamma_2 \simeq \gamma$ for any closed, rectifiable γ with winding number 1 in the annulus $R_1 < |z-a| < R_2$, and the function $g(w)$ we started integrating is analytic there, so we can change the paths to be equal.

Hence finally, remembering that the right-hand side of Equation (8.1.1) is $2\pi i f(z)$, we get

$$f(z) = \sum_{n=-\infty}^{\infty} \left(\frac{1}{2\pi i} \int_{\gamma} \frac{f(w)}{w^{n+1}} dw \right) z^n,$$

so we have the series representation we need and we call the coefficients given by the integral a_n .

It remains to show uniqueness. To this end, suppose

$$f(z) = \sum_{n=-\infty}^{\infty} a_n z^n.$$

Then

$$\int_{\gamma} \frac{f(z)}{z^{k+1}} dz = \sum_{n=-\infty}^{\infty} a_n \int_{\gamma} z^{n-k-1} dz.$$

Now if $n \geq k+1$, so that the power of the integrand is nonnegative, this integral is zero since the integrand is analytic. Similarly if $n < k$, so that the power is -2 or smaller, the integrand has a primitive, so again is analytic. The only outstanding option is if $n = k$, so that the integrand is z^{-1} . In that case by Cauchy's theorem the integral is $2\pi i$, so the above sum picks up the $n = k$ term and equals

$$\int_{\gamma} \frac{f(z)}{z^{k+1}} dz = 2\pi i a_k.$$

But then we see that

$$a_k = \frac{1}{2\pi i} \int_{\gamma} \frac{f(z)}{z^{k+1}} dz,$$

which is the same coefficient we claimed was unique. \square

In summary, then: Let

$$f(z) = \sum_{n=-\infty}^{\infty} a_n(z-a)^n$$

be the Laurent expansion of f about an isolated singularity $z = a$. Then

- (i) if f has a removable singularity at $z = a$, then $a_{-n} = 0$ for all $n \geq 1$;
- (ii) if f has a pole of order m at $z = a$, then $a_{-m} \neq 0$ and $a_{-n} = 0$ for all $n > m$;
- (iii) if f has an essential singularity at $z = a$, then there are infinitely many $a_{-n} \neq 0$, $n \geq 1$.

Exercise 8.1. Find the Laurent expansion for

- (a) $\frac{1}{z^4 + z^2}$ about $z = 0$,
- (b) $\frac{1}{z^2 - 4}$ about $z = 2$. \blacksquare

In much the same way as analytic functions have isolated zeros, so are poles of these creatures:

Exercise 8.2. Let G be an open subset of \mathbb{C} . Suppose $f: G \rightarrow \mathbb{C}$ is analytic except for poles. Show that the poles of f can not have a limit point in G . \blacksquare

Since a function doesn't have a nice limit at an essential singularity, we might expect it to behave strangely there, and indeed this is the case:

Theorem 8.1.3 (Casorati–Weierstrass theorem). *If f has an essential singularity at $z = a$, then for any $\delta > 0$, $f(A_\delta) = \mathbb{C}$ where $A_\delta = \{z \in \mathbb{C} \mid 0 < |z-a| < \delta\}$.*

Proof. Suppose the theorem is false, i.e., there exists some $c \in \mathbb{C}$ and $\varepsilon > 0$ such that $|f(z) - c| > \varepsilon$ for every $z \in A_\delta$ and every $\delta > 0$. Then

$$\lim_{z \rightarrow a} \frac{|f(z) - c|}{|z - a|} = \infty,$$

so $\frac{f(z)-c}{z-a}$ has a pole at $z = a$. Let m be the order of this pole, so

$$\frac{f(z) - c}{z - a} = \frac{g(z)}{(z - a)^m}$$

where $g(a) \neq 0$ and g is analytic. Hence

$$f(z) = \frac{g(z)}{(z - a)^{m-1}} + c,$$

for $z \neq a$. Note that the constant c is analytic, so if $m = 1$, then $f(z)$ has a removable singularity at $z = a$, a contradiction, and if $m \geq 2$, then $f(z)$ has a pole of order $m - 1$ at $z = a$, also a contradiction. \square

8.2 Residues

Definition 8.2.1 (Residue). Let $z = a$ be an isolated singularity of f and

$$f(z) = \sum_{n=-\infty}^{\infty} a_n(z-a)^n$$

be the Laurent expansion of f about $z = a$. The **residue** of $z = a$ is the coefficient a_{-1} , denoted by

$$\operatorname{Res}(f; a) \quad \text{or} \quad \operatorname{Res}_{z=a} f(z).$$

We know by Cauchy's theorem that if a function is analytic in $0 < |z-a| < R$, then for $\gamma(t) = a + re^{it}$, $0 \leq t \leq 2\pi$, we have

$$a_{-1} = \frac{1}{2\pi i} \int_{\gamma} f(z) dz,$$

and so we should expect this to hold in some kind of generality:

Theorem 8.2.2 (Cauchy's residue theorem). *Let f be analytic in a region G except for isolated singularities b_1, b_2, \dots, b_m . Let γ be a closed rectifiable curve in G such that $b_k \notin \{\gamma\}$ for $k = 1, 2, \dots, m$. Suppose $\gamma \simeq 0$ in G . Then*

$$\frac{1}{2\pi i} \int_{\gamma} f(z) dz = \sum_{k=1}^m n(\gamma; b_k) \operatorname{Res}(f; b_k).$$

Sketch of proof. Suppose γ encloses only one isolated singularity, b_1 , and let

$$f(z) = \sum_{n=-\infty}^{\infty} a_n(z-b_1)^n$$

be the Laurent expansion of f around $z = b_1$. Then, by the same calculations as previously,

$$\frac{1}{2\pi i} \int_{\gamma} f(z) dz = \frac{1}{2\pi i} \int_{\gamma} \frac{a_{-1}}{z-b_1} dz = a_{-1} n(\gamma; b_1),$$

where $a_{-1} = \operatorname{Res}(f; b_1)$.

If γ encloses more poles, then by adding and subtracting paths cutting them off from one another, and for each resulting smaller curve around one isolated singularity expanding f as a Laurent series around that singularity, we get the full result. \square

In practice it is often useful to have an easier way to compute residues than this integral:

Proposition 8.2.3. *Suppose f has a pole of order m at $z = a$. Let $g(z) = (z-a)^m f(z)$. Then*

$$\operatorname{Res}(f; a) = \frac{1}{(m-1)!} g^{(m-1)}(a).$$

Proof. By the discussion at the end of last lecture, the Laurent expansion of f around $z = a$ looks like

$$f(z) = \frac{b_{-m}}{(z-a)^m} + \frac{b_{-(m-1)}}{(z-a)^{m-1}} + \cdots + \frac{b_{-1}}{z-a} + b_0 + b_1(z-a) + b_2(z-a)^2 + \dots$$

Our goal is to extract b_{-1} , so

$$g(z) = (z-a)^m f(z) = b_{-m} + b_{-(m-1)}(z-a) + \cdots + b_{-1}(z-a)^{m-1} + b_0(z-a)^m + \dots,$$

and hence the $(m-1)$ st derivative is

$$g^{(m-1)}(z) = (m-1)!b_{-1} + m(m-1)\dots 3 \cdot 2b_0(z-a) + \dots,$$

and evaluating this at $z = a$, all but the constant term vanish, so $g^{(m-1)}(a) = (m-1)!b_{-1}$. \square

Lecture 9 The Argument Principle

9.1 Residue calculus

Residues offer a very powerful tool for evaluating real integrals, as it happens.

Example 9.1.1. We have

$$\int_{-\infty}^{\infty} \frac{x^2}{1+x^4} dx = \frac{\pi}{\sqrt{2}}.$$

Evaluating this as a real integral is very hard, but evaluating it as a carefully constructed complex integral is comparatively easy. To this end, let $f(z) = \frac{z^2}{1+z^4}$. This function has poles where $z^4 = 1$, i.e., $z_i = e^{i\theta_i}$, for $\theta_1 = \frac{\pi}{4}$, $\theta_2 = \frac{3\pi}{4}$, $\theta_3 = \frac{5\pi}{4}$, and $\theta_4 = \frac{7\pi}{4}$.

Now consider integrating this over the semicircle γ of radius $R > 1$ sitting on the real axis, so that the circular part is parametrised by $z = Re^{i\theta}$, $0 \leq \theta \leq \pi$, and $dz = Rie^{i\theta} d\theta$, see Figure 9.1.1. Then by Cauchy's residue theorem

$$\frac{1}{2\pi i} \int_{\gamma} f(z) dz = \operatorname{Res}_{z=z_1} f(z) + \operatorname{Res}_{z=z_2} f(z),$$

since those are the only poles inside γ . In particular

$$\begin{aligned} \operatorname{Res}_{z=z_1} f(z) &= \lim_{z \rightarrow z_1} (z - z_1) f(z) \\ &= \lim_{z \rightarrow z_1} \frac{z^2}{(z - z_2)(z - z_3)(z - z_4)} = \frac{1}{4} e^{-\frac{\pi}{4}i}, \end{aligned}$$

and by completely analogous computations

$$\operatorname{Res}_{z=z_2} f(z) = \frac{1}{4} e^{i\frac{3\pi}{4}i}.$$

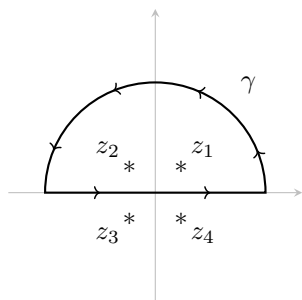

Figure 9.1.1: A positively oriented semicircle of radius R enclosing two poles (labelled $*$) of f .

Hence, after some calculation,

$$\frac{1}{2\pi i} \int_{\gamma} f(z) dz = -\frac{i}{2\sqrt{2}}.$$

Now on the other hand

$$\frac{1}{2\pi i} \int_{\gamma} f(z) dz = \frac{1}{2\pi i} \int_{-R}^R \frac{x^2}{1+x^4} dx + \frac{1}{2\pi} \int_0^{\pi} \frac{R^2 e^{i2\theta}}{1+R^4 e^{i4\theta}} R e^{i\theta} d\theta.$$

Letting $R \rightarrow \infty$, this first integral converges to the real integral we are interested in, and the second integral goes to 0:

$$\left| \frac{1}{2\pi} \int_0^{\pi} \frac{R^3 e^{i3\theta}}{1+R^4 e^{i4\theta}} d\theta \right| \leq \frac{1}{2\pi} \int_0^{\pi} \frac{R^3}{R^4-1} d\theta = \frac{1}{2} \frac{R^3}{R^4-1} \rightarrow 0$$

as $R \rightarrow \infty$. Hence

$$-\frac{i}{2\sqrt{2}} = \frac{1}{2\pi i} \int_{-\infty}^{\infty} \frac{x^2}{1+x^4} dx,$$

which, when rearranged, yields

$$\int_{-\infty}^{\infty} \frac{x^2}{1+x^4} dx = \frac{\pi}{\sqrt{2}}. \quad \blacktriangle$$

Exercise 9.1. Show that:

(a) $\int_0^{\infty} \frac{1}{(x^2+a^2)^2} dz = \frac{\pi}{4a^3}$ for $a > 0$,

(b) $\int_{-\infty}^{\infty} \frac{e^{ax}}{1+e^x} dx = \frac{\pi}{\sin(a\pi)}$ for $0 < a < 1$. ■

9.2 The argument principle

Definition 9.2.1 (Meromorphic). A function f is said to be *meromorphic* on G if f is analytic on G except for isolated poles.

We know two things about these, from earlier: If f has a zero of order or multiplicity m at $z = a$, then $f(z) = (z-a)^m g(z)$ where g is analytic near $z = a$ and $g(a) \neq 0$. Therefore

$$\frac{f'(z)}{f(z)} = \frac{m}{z-a} + \frac{g'(z)}{g(z)},$$

and so if γ is a closed rectifiable curve around a , enclosing no other poles or zeros of f , then

$$\frac{1}{2\pi i} \int_{\gamma} \frac{f'(z)}{f(z)} dz = m \cdot n(\gamma; a).$$

Similarly, if f has a pole of order m at $z = a$, then $f(z) = \frac{g(z)}{(z-a)^m}$, where again $g(z)$ is analytic near $z = a$ and $g(a) \neq 0$. Then

$$\frac{f'(z)}{f(z)} = \frac{-m}{z-a} + \frac{g'(z)}{g(z)},$$

so

$$\frac{1}{2\pi i} \int_{\gamma} \frac{f'(z)}{f(z)} dz = -m \cdot n(\gamma; a).$$

We can do this in general:

Theorem 9.2.2 (Argument principle). *Let f be meromorphic on F with poles p_1, p_2, \dots, p_m and zeros z_1, z_2, \dots, z_n , counted according to multiplicity/order. Let γ be a closed, rectifiable curve in G with $\gamma \simeq 0$ and $p_j \notin \{\gamma\}$ and $z_i \notin \{\gamma\}$ for all i and j . Then*

$$\frac{1}{2\pi i} \int_{\gamma} \frac{f'(z)}{f(z)} dz = \sum_{i=1}^n n(\gamma; z_i) - \sum_{j=1}^m n(\gamma; p_j).$$

Proof. By the same considerations as above, we can write

$$f(z) = \frac{(z - z_1)(z - z_2) \cdots (z - z_n)}{(z - p_1)(z - p_2) \cdots (z - p_m)} g(z),$$

where g is analytic inside γ , and $g(z) \neq 0$ for all z inside γ . Then

$$\frac{f'(z)}{f(z)} = \sum_{i=1}^n \frac{1}{z - z_i} - \sum_{j=1}^m \frac{1}{z - p_j} + \frac{g'(z)}{g(z)}.$$

Integrating this we get the above formula, since each term has only one simple pole inside γ . \square

Exercise 9.2. Let f be a meromorphic function on a neighbourhood of $\overline{B(a; R)}$ with no zeros or poles on $\gamma = \{z \mid |z - a| = R\}$. Let z_1, z_2, \dots, z_n be the zeros of f and p_1, p_2, \dots, p_m be the poles of f (counted according to multiplicity) in $B(a; R)$. Show that

$$\frac{1}{2\pi i} \int_{\gamma} z \frac{f'}{f} = \sum_{i=1}^n z_i - \sum_{j=1}^m p_j. \quad \blacksquare$$

A very natural question to now ask is why we call this ‘the argument principle’. To answer this, suppose for a moment we can define $\log f(z)$. Then

$$(\log f(z))' = \frac{f'(z)}{f(z)},$$

so the integrand above has a primitive, meaning that for any closed, rectifiable γ ,

$$\frac{1}{2\pi i} \int_{\gamma} \frac{f'(z)}{f(z)} dz = \log f(z) \Big|_{z=a}^{z=a} = 0.$$

However, we define $\log z := \log|z| + i \arg z$, and for this to make sense we need, apart from $z \neq 0$, to make a branch cut, i.e., pick an open interval of length 2π for the argument. Hence $\log f(z)$ is defined if $f(z) \neq 0$ and $f(z)$ doesn't lie on the line removed by the branch cut. But we have zeros and poles, meaning that $f(z) = 0$ for some z or $f(z) = \infty$ (in a manner of speaking) for some z , both of which lie on any line removed by any branch cut. So if f has any zeros or poles inside γ , $\log f(z)$ is not defined.

But for z on γ itself there are no zeros or poles of f (by hypothesis), so for any $a \in \gamma$, $\log f(z)$ is defined near $z = a$.

In other words, if we call the little arc of γ lying near a , say, γ_1 , with starting point $z = b$ and endpoint $z = c$, then

$$\int_{\gamma_1} \frac{f'(z)}{f(z)} dz = \log f(z) \Big|_{z=b}^{z=c} = \log f(c) - \log f(b),$$

and picking a branch this is

$$\log|f(c)| - \log|f(b)| + i(\arg f(c) - \arg f(b)),$$

so the imaginary part of this integral measures the change of angles of $f(z)$ as z moves from $z = b$ to $z = c$.

For each $a \in \gamma$, $f(a) \neq 0$, so we can define $\log f(z)$ on $B(a, r_a)$ for some sufficiently small $r_a > 0$. This means that $\{B(a, r_a) \mid a \in \gamma\}$ is an open cover of γ , and γ is compact, so there exists a finite subcover. Moreover, if we parametrise γ over $t \in [0, 1]$, then by Lebesgue's number lemma, there exists some $\varepsilon > 0$ such that for any partition

$$0 = t_0 < t_1 < t_2 < \cdots < t_{n-1} < t_n = 1$$

with $|t_{j-1} - t_j| < \varepsilon$, we have $\gamma([t_j, t_{j-1}]) \subset B(a, r_a)$ for some $a \in \gamma$. Now we want to define $\log f(z)$ on $B(a, r_a)$. So $\log f(z) := \log|f(z)| + i \arg_j f(z)$ on $\gamma([t_j, t_{j+1}])$ for $j = 0, 1, \dots, k-1$. Now we choose the branches in such a way that $\arg_0 f(\gamma(t_1)) = \arg_1 f(\gamma(t_1))$, $\arg_1 f(\gamma(t_2)) = \arg_2 f(\gamma(t_2))$, and so on, so that at the transition from one ball to another the argument doesn't jump.

Let $\gamma_j = \gamma([t_j, t_{j+1}])$. Then

$$\int_{\gamma_j} \frac{f'(z)}{f(z)} dz = \log|f(\gamma(t_{j+1}))| - \log|f(\gamma(t_j))| + i(\arg_j f(\gamma(t_{j+1})) - \arg_j f(\gamma(t_j))).$$

Hence

$$\begin{aligned} \int_{\gamma} \frac{f'(z)}{f(z)} dz &= \sum_{j=0}^{k-1} \int_{\gamma_j} \frac{f'(z)}{f(z)} dz \\ &= \log|f(1)| - \log|f(\gamma(0))| + i \left(\arg_{k-1} f(\gamma(1)) - \arg_0 f(\gamma(0)) \right) \end{aligned}$$

since the resulting sum is telescoping.

This means that if γ is a closed curve, then of course

$$\int_{\gamma} \frac{f'(z)}{f(z)} dz = 2\pi i \cdot k$$

for some integer k , but γ is not necessarily a closed curve. Suppose γ is a curve from $z = a$ to $z = b$. Then

$$\operatorname{Im} \left(\int_{\gamma} \frac{f'(z)}{f(z)} dz \right)$$

measures precisely the continuous variation of the argument of f along γ . This, then, is why we call it the argument principle.

As a consequence of this discussion:

Theorem 9.2.3 (Rouché's theorem). *Suppose f and g are meromorphic in a neighbourhood of $\overline{B(a, R)}$ and with no zeros or poles on the boundary $\gamma = \{z \mid |z - a| = R\}$. Let $Z(f)$, $Z(g)$, $P(f)$, and $P(g)$ denote the number of zeros of f and g and the number of poles of f and g inside γ , counted according to multiplicity or order. Suppose*

$$|f(z) + g(z)| < |f(z)| + |g(z)|$$

on γ . Then

$$Z(f) - P(f) = Z(g) - P(g).$$

Remark 9.2.4. In applications, we frequently care about the special case where the functions are analytic, making $P(f) = P(g) = 0$, and $|f(z) + g(z)| < |f(z)|$, then implying f and g have equally many zeros inside γ .

Proof. By hypothesis $|f(z) + g(z)| < |f(z)| + |g(z)|$ on γ . Dividing by $g(z)$, which we can do since by assumptions g has no zeros on γ , we get

$$\left| \frac{f(z)}{g(z)} + 1 \right| < \left| \frac{f(z)}{g(z)} \right| + 1$$

on γ . Let $\lambda = \frac{f(z)}{g(z)}$ for $z \in \gamma$. If $\lambda \in \mathbb{R}_{\geq 0}$, then we get $\lambda + 1 < \lambda + 1$, which is impossible. Hence λ will never touch the nonnegative real axis, so we can take that as our branch cut and define

$$\log \frac{f(z)}{g(z)} = \log \left| \frac{f(z)}{g(z)} \right| + i \arg \frac{f(z)}{g(z)}$$

for $0 < \arg \frac{f(z)}{g(z)} < 2\pi$. Thus $\frac{(f/g)'}{(f/g)}$ has a primitive, and so

$$\frac{1}{2\pi i} \int_{\gamma} \frac{(f/g)'}{(f/g)}(z) dz = 0,$$

but

$$\left(\frac{f(z)}{g(z)} \right)' = \frac{f'(z)g(z) - f(z)g'(z)}{g(z)^2},$$

so

$$\frac{(f/g)'}{(f/g)}(z) = \frac{f'(z)g(z) - f(z)g'(z)}{g(z)^2} \frac{g(z)}{f(z)} = \frac{f'(z)}{f(z)} - \frac{g'(z)}{g(z)},$$

so the above integral is also

$$0 = \frac{1}{2\pi i} \int_{\gamma} \frac{f'(z)}{f(z)} - \frac{g'(z)}{g(z)} dz = (Z(f) - P(f)) - (Z(g) - P(g)). \quad \square$$

Lecture 10 Bounds of Analytic Functions

10.1 Simple bounds

The first bound of analytic functions that is of very frequent use we have already met (see page 18):

Theorem 10.1.1 (Maximum modulus principle). *Let G be a region and let $f: G \rightarrow \mathbb{C}$ be an analytic function. Suppose there exists some $a \in G$ such that $|f(a)| \geq |f(z)|$ for all $z \in G$. Then f is a constant function.*

An equivalent statement that we make frequent use of is

Corollary 10.1.2. *Let G be a region and let $f: G \rightarrow \mathbb{C}$ be an analytic function. Suppose*

$$\limsup_{z \rightarrow a} |f(z)| \leq M$$

for all $a \in \partial_\infty G$ for some $M > 0$.⁴ Then

$$|f(z)| \leq M$$

for all $z \in G$.

In other words, the maximum of an analytic function on the interior of a closed set must occur at the boundary of the set.

Theorem 10.1.3 (Schwarz lemma). *Let $D = \{z \mid |z| < 1\}$ be the unit disk. Suppose $f: D \rightarrow \mathbb{C}$ be an analytic function such that*

(i) $|f(z)| \leq 1$ for all $z \in D$ (i.e., $f: D \rightarrow \overline{D}$), and

(ii) $f(0) = 0$.

Then $|f'(0)| \leq 1$ and $|f(z)| \leq |z|$ for every $z \in D$ (so the image can only shrink or remain the same size, not grow). Moreover, if $|f'(0)| = 1$ or if $|f(z)| = |z|$ for some $z \in D$, then there exists a $c \in \mathbb{C}$ with $|c| = 1$ such that $f(z) = cz$ for all $z \in D$.

Proof. Define $g: D \rightarrow \mathbb{C}$ by

$$g(z) = \begin{cases} \frac{f(z)}{z}, & \text{if } z \neq 0 \\ f'(0), & \text{if } z = 0. \end{cases}$$

Then $g(z)$ is analytic in D . On $|z| = r$ for $0 < r < 1$,

$$|g(z)| = \frac{|f(z)|}{|z|} \leq \frac{1}{r},$$

and letting $r \rightarrow 1$ we see by the Maximum modulus principle that $|g(z)| \leq 1$ for all $z \in D$.

This implies in particular that $|g(0)| = |f'(0)| \leq 1$, and $|\frac{f(z)}{z}| \leq 1$, so $|f(z)| \leq |z|$.

The two special cases now follow quite readily: if $f'(0) = 1$, then from the first one $|g(z)|$ attains its maximum in D , so by the Maximum modulus principle $g(z) = c = g(0) = f'(0)$ for some $|c| = 1$, so $f(z) = cz$.

For the second one, if $|\frac{f(z_0)}{z_0}| = 1$ for some $z_0 \in D$, then again $|g(z)|$ attains its maximum in D , so $g(z) = z$, and $f(z) = cz$, where $|c| = |\frac{f(z_0)}{z_0}| = 1$. \square

⁴By $\partial_\infty G$ we mean $\partial G \cup \{\infty\}$ in the case where G is unbounded.

10.2 Automorphisms of the unit disk

An interesting consequence of this lemma is that it lets us characterise the automorphisms of the unit disk.

Definition 10.2.1 (Automorphism). A one-to-one, bi-analytic mapping of a region G onto G is called an *automorphism* of G .

In other words, $f: G \rightarrow G$ is injective, surjective, analytic, and its inverse is also analytic.

We will denote by $\text{Aut}(G)$ the set of all automorphisms of G .

Note that, being analytic and one-to-one, an automorphism is also necessarily conformal.

Remark 10.2.2. The bi-analytic condition in this definition is strictly speaking superfluous: a function that is one-to-one, onto, and analytic necessarily has analytic inverse.

Exercise 10.1. Let f be an analytic function on a neighbourhood of $\overline{B(a; R)}$. Suppose that f is one-to-one on $B(a; R)$. Let $\Omega := f(B(a; R))$ and $\gamma = \{z \mid |z - a| = R\}$. Show that

$$f^{-1}(w) = \frac{1}{2\pi i} \int_{\gamma} \frac{zf'(z)}{f(z) - w} dz$$

for all $w \in \Omega$. ■

Let $D = \{z \in G \mid |z| < 1\}$ denote the unit disk in the preceding discussion. Let $a \in \mathbb{C}$ with $|a| < 1$, and define the Möbius transformation

$$\varphi_a(z) = \frac{z - a}{1 - \bar{a}z}.$$

Notice how φ_a is analytic for $|z| < \frac{1}{|a|}$, but $\frac{1}{|a|} > 1$, so φ_a is analytic on a neighbourhood of \overline{D} .

By straight-forward calculation

$$\varphi_a(\varphi_{-a}(z)) = \varphi_a\left(\frac{z + a}{1 + \bar{a}z}\right) = \frac{\frac{z+a}{1+\bar{a}z} - a}{1 - \bar{a}\frac{z+a}{1+\bar{a}z}} = \frac{z + a - a - |a|^2 z}{1 + \bar{a}z - \bar{a}z - |a|^2} = z,$$

and for exactly the same reason

$$\varphi_{-a}(\varphi_a(z)) = z,$$

so $\varphi_a: D \rightarrow D$ so a one-to-one and onto analytic mapping, and its inverse φ_{-a} is as well, so φ_a is an automorphism of D .

We strictly speaking already know it, being one-to-one and analytic, but in this case it is also easy to verify that

$$\varphi_a'(z) = \frac{1 - |a|^2}{(a - \bar{a}z)^2} \neq 0$$

for all $z \in D$, so φ_a is also conformal.

On the unit circle $\partial D = \{z \mid |z| = 1\}$, i.e., $z = e^{i\theta}$ for $\theta \in \mathbb{R}$,

$$|\varphi_a(e^{i\theta})| = \left| \frac{e^{i\theta} - a}{1 - \bar{a}e^{i\theta}} \right| = \left| \frac{1}{e^{i\theta}} \frac{e^{i\theta} - a}{e^{-\theta} - \bar{a}} \right| = 1$$

since the second fraction is a quotient of complex conjugates. In other words $\varphi_a(\partial D) = \partial D$.

So in summary, if we let $|a| < 1$ and define $\varphi_a: D \rightarrow D$ by

$$\varphi_a(z) = \frac{z - a}{1 - \bar{a}z}.$$

Then φ_a is one-to-one, onto, with its inverse being φ_{-a} ; $\varphi_a(\partial D) = \partial D$; and $\varphi_a(a) = 0$, $\varphi'_a(0) = 1 - |a|^2$, and $\varphi'_a(a) = \frac{1}{1 - |a|^2}$.

Exercise 10.2. (a) Let $D = \{z \mid |z| < 1\}$. Let $f: D \rightarrow \mathbb{C}$ be an analytic function. Suppose that $|f(z)| \leq 1$ for all $z \in D$ and $f(a) = \alpha$. Show that

$$|f'(a)| \leq \frac{1 - |\alpha|^2}{1 - |a|^2}.$$

(b) Does there exist an analytic function $f: D \rightarrow D$ with $f(\frac{1}{2}) = \frac{3}{4}$ and $f'(\frac{1}{2}) = \frac{2}{3}$? ■

Exercise 10.3. Let $f: D \rightarrow \mathbb{C}$ be a non-constant analytic function such that $|f(z)| \leq 1$ for all $z \in D$. Show that

$$\frac{|f(0)| - |z|}{1 + |f(0)||z|} \leq |f(z)| \leq \frac{|f(0)| + |z|}{1 - |f(0)||z|}. \quad \blacksquare$$

Exercise 10.4 (Borel–Carathéodory’s inequality). Let f be analytic on the closed disk $\overline{B}(a; R)$ and let

$$M(r) = \max\{|f(z)| \mid |z| = r\}, \quad A(r) = \max\{\operatorname{Re} f(z) \mid |z| = r\}.$$

(a) Show that $A(r)$ is a monotone increasing function.

(b) Show that for $0 < r < R$,

$$M(r) \leq \frac{2r}{R - r}A(R) + \frac{R + r}{R - r}|f(0)|. \quad \blacksquare$$

Not only are these automorphisms of D , but, up to rotations, all automorphisms of D are one of these:

Theorem 10.2.3 (Schwarz–Pick theorem). *Let $f: D \rightarrow D$ be a one-to-one, onto, analytic map. Suppose $f(a) = 0$. Then there exists $c \in \mathbb{C}$ such that $f(z) = c\varphi_a(z)$ (i.e., a rotation of a Möbius map). Hence*

$$\operatorname{Aut}(D) = \{c\varphi_a \mid a \in \mathbb{C}, |a| < 1, c \in \mathbb{C}, |c| = 1\}.$$

Proof. Let $g(z) = f(\varphi_{-a}(z)): D \rightarrow D$. Then since $f(a) = 0$ by assumption and $\varphi_a(a) = 0$, meaning that $\varphi_{-a}(0) = a$, we have

$$\begin{array}{ccccc} & & g & & \\ & \curvearrowright & & \curvearrowleft & \\ D & \xrightarrow{\varphi_{-a}} & D & \xrightarrow{f} & D \\ & \longmapsto & a & \longmapsto & 0, \end{array}$$

so $g(0) = f(f_{-a}(0)) = f(a) = 0$. Both of these maps are one-to-one and onto, so they have inverses, and hence g^{-1} exists. Moreover $|g(z)| \leq 1$ for all $z \in D$ (simply since $g: D \rightarrow D$), so by Schwarz lemma $|g(z)| \leq |z|$ for all $|z| < 1$.

But the inverse map satisfies the exact same conditions, so $|g^{-1}(z)| \leq |z|$ for all $|z| < 1$, so

$$|g(z)| \leq |z| = |g^{-1}(g(z))| \leq |g(z)|,$$

meaning that $|g(z)| = |z|$. Hence by the second part of Schwarz lemma, $g(z) = cz$ for some $|c| = 1$, so $f(\varphi_{-a}(z)) = cz$. Replacing z by $\varphi_a(z)$, this becomes $f(z) = c\varphi_a(z)$ for all $|z| < 1$. \square

10.3 Automorphisms of the upper half-plane

An analogous (and as we will see very much related) statement is about characterising the automorphisms of the complex *upper half-plane* $\mathbb{H} = \{x + iy \in \mathbb{C} \mid y > 0\}$.

Example 10.3.1. One example of such an automorphism is the *Cayley transform*

$$\psi(z) = \frac{z - i}{z + i},$$

which is evidently a Möbius transformation. We see that $\psi(\mathbb{R}_\infty) = \partial D$ since for real x ,

$$|\psi(x)| = \left| \frac{x - i}{x + i} \right| = 1$$

since, as once earlier, this is a quotient of complex conjugates. Note moreover how $\psi(i) = 0$, and since ψ is analytic, it is continuous, and a continuous function maps connected sets to connected sets, so the upper half-plane must map to the unit disk D , since the boundary of the upper half-plane, that is \mathbb{R}_∞ , maps to the boundary of the unit disk.

More generally, letting

$$\varphi_\alpha(z) = \frac{z - \alpha}{z - \bar{\alpha}}$$

for $\text{Im}(\alpha) > 0$, then $\varphi_\alpha(\mathbb{R}_\infty) = \partial D$, $\varphi_\alpha(\alpha) = 0$, and then $\varphi_\alpha: \mathbb{H} \rightarrow D$ is a one-to-one, onto, and conformal mapping (where in particular of course $\psi = \psi_i$). \blacktriangle

Theorem 10.3.2. *We have*

$$\text{Aut}(\mathbb{H}) = \left\{ f(z) = \frac{az + b}{cz + d} \mid a, b, c, d \in \mathbb{R}, ad - bc > 0 \right\}.$$

Proof. For $f(z) = \frac{az+b}{cz+d}$, $a, b, c, d \in \mathbb{R}$ and $ad - bc > 0$, we naturally have $f(\mathbb{R}_\infty) = \mathbb{R}_\infty$. Moreover

$$\text{Im}(f(i)) = \frac{ad - bc}{c^2 + d^2} > 0,$$

so by the same connected set argument as above $f: \mathbb{H} \rightarrow \mathbb{H}$, and so $f \in \text{Aut}(\mathbb{H})$.

Next let $f \in \text{Aut}(\mathbb{H})$, and suppose $f(i) = \alpha$ with $\text{Im}(\alpha) > 0$. The strategy is to leverage what we already know about automorphisms of D , so in order to

carry this situation over to D , consider the diagram

$$\begin{array}{ccc}
 i & \xrightarrow{\quad} & 0 \\
 \mathbb{H} & \xrightarrow{\psi} & D \\
 \downarrow f & & \downarrow g \\
 \mathbb{H} & \xrightarrow{\psi_\alpha} & D \\
 \alpha & \xrightarrow{\quad} & 0.
 \end{array}$$

In other words, let $\psi(z) = \frac{z-i}{z+i}$ be the Cayley transform and $\psi_\alpha(z) = \frac{z-\alpha}{z-\bar{\alpha}}$, and define $g: D \rightarrow D$ by $g = \psi_\alpha \circ f \circ \psi^{-1}$. Then

$$g(0) = \varphi_\alpha \circ f \circ \psi^{-1}(0) = \varphi_\alpha(f(i)) = \varphi_\alpha(\alpha) = 0.$$

Moreover $g \in \text{Aut}(D)$ since it is one-to-one, onto, and analytic, so by the Schwarz–Pick theorem $g(z) = cz$ for some $|c| = 1$. Then, solving the diagram above for f ,

$$f(z) = \psi_\alpha^{-1} \circ g \circ \psi(z) = \psi_\alpha^{-1}(g(\psi(z))) = \psi_\alpha^{-1}(c\psi(z)).$$

Here $c\psi_\alpha(z) = \frac{cz+c\alpha}{cz-c\bar{\alpha}}$ is a Möbius transformation, and so is ψ_α^{-1} , so their composition is too. Hence f is a Möbius transformation.

Now $f \in \text{Aut}(\mathbb{H})$, so $f(\mathbb{R}_\infty) = \mathbb{R}_\infty$, and a Möbius transformation mapping the real line to itself can be written as $f(z) = \frac{az+b}{cz+d}$ with $a, b, c, d \in \mathbb{R}$. Moreover $\text{Im}(f(i)) = \text{Im}(\alpha) > 0$ by assumption, so

$$\text{Im}(f(i)) = \frac{ad - bc}{c^2 + d^2} > 0,$$

meaning that $ad - bc > 0$. □

As we have discussed before, Möbius transformations are invariant under multiplying the numerator and denominator by a constant, so we can always normalise in such a way that $\text{Aut}(\mathbb{H})$ is identified by

$$\begin{pmatrix} a & b \\ c & d \end{pmatrix} \in \text{SL}_2(\mathbb{R}) = \left\{ \begin{pmatrix} a & b \\ c & d \end{pmatrix} \mid a, b, c, d \in \mathbb{R}, ad - bc = 1 \right\}.$$

Making a brief detour into measure theory, this set of matrices has a group structure, and so $\text{Aut}(\mathbb{H})$ inherits this group structure, and in fact it is a Lie group. (Indeed a theorem by Henri Cartan guarantees that any automorphism group of a region is a Lie group.) Being a Lie group there exists a unique measure invariant under the group action, known as the Haar measure, and this provides a corresponding measure on \mathbb{H} , namely the hyperbolic measure

$$d\mu(z) = \frac{dx dy}{y^2},$$

which then is invariant under group action by $\text{Aut}(\mathbb{H})$.

Theorem 10.3.3 (Hadamard three-lines theorem). *Let G be the vertical strip $\{x + iy \in \mathbb{C} \mid a < x < b\}$. Suppose $f: \overline{G} \rightarrow \mathbb{C}$ is continuous, not identical to 0, and bounded. Suppose f is analytic in \mathbb{C} .*

Define $M: [a, b] \rightarrow \mathbb{R}$ by

$$M(x) := \sup_{-\infty < y < \infty} |f(x + iy)|.$$

Then $\log M(x)$ is a convex function, i.e., for $a \leq x < u < y \leq b$,

$$\log M(u) \leq \frac{y-u}{y-x} \log M(x) + \frac{u-x}{y-x} \log M(y).$$

Lecture 11 Hadamard Three-Lines Theorem

11.1 Generalising the maximum modulus principle

In order to prove the Hadamard three-lines theorem stated at the end of last lecture, we first need the following lemma:

Lemma 11.1.1. *Let f and G be as in the Hadamard three-lines theorem. Suppose $|f(z)| \leq 1$ on ∂G (not including ∞). Then $|f(z)| \leq 1$ for all $z \in G$.*

In other words, this is essentially the Maximum modulus principle except on a (special kind of) unbounded domain.

Proof. For any $\varepsilon > 0$, define the function $g_\varepsilon(z) = \frac{1}{1 + \varepsilon(z-a)}$ for all $z \in \overline{G}$. Then g_ε is analytic in G , since the denominator is never 0 there. For any $z = x + iy \in \overline{G}$, since the magnitude of a complex number is bounded below by the magnitude of its real value,

$$|g_\varepsilon(z)| \leq \frac{1}{|\operatorname{Re}(1 + \varepsilon(z-a))|} = \frac{1}{1 + \varepsilon(x-a)} \leq 1$$

since $0 \leq x - a$. This means that since $|f(z)| \leq 1$ on ∂G , we also have $|f(z)g_\varepsilon(z)| \leq 1$ on $z \in \partial G$.

The idea is that as the imaginary part of z is big, $g_\varepsilon(z)$ is very small, so for large heights we can ‘dampen’ whatever f is doing in the product. More precisely, by assumption f is bounded in G , say $|f(z)| \leq B$ for all $z \in G$, and so

$$|f(z)g_\varepsilon(z)| \leq \frac{B}{|1 + \varepsilon(z-a)|} \leq \frac{B}{\varepsilon|\operatorname{Im} z|}$$

for $|\operatorname{Im} z| > 0$, since the magnitude of a complex number is also bounded below by the magnitude of its imaginary part. Hence if we take z to have imaginary part larger than $\frac{B}{\varepsilon}$, the product is bounded by 1 in this strip, as we want, and in what remains we can use the ordinary Maximum modulus principle.

All by way of saying: for $z = x + iy \in G$, with $|y| \geq \frac{B}{\varepsilon}$, we therefore have $|f(z)g_\varepsilon(z)| \leq 1$.

In the remaining rectangle $R = \{x + iy \mid a \leq x \leq b, |y| \leq \frac{B}{\varepsilon}\}$, we have by the above discussion that $|f(z)g_\varepsilon(z)| \leq 1$ on ∂R , and so by the Maximum modulus principle $|f(z)g_\varepsilon(z)| \leq 1$ also on R , and hence, combining the two parts, on G .

Thus

$$|f(z)| \leq \frac{1}{|g_\varepsilon(z)|} = |1 + \varepsilon(z-a)|,$$

which goes to 1 as ε goes to 0. Hence finally $|f(z)| \leq 1$ on G as desired. \square

Date: September 24th, 2019.

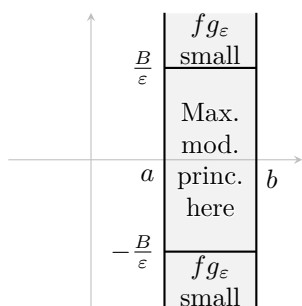

Figure 11.1.1: Split strip into bounded and unbounded portions.

With this we are equipped to prove the Hadamard three-lines theorem:

Proof. Note first how the statement we are to prove is equivalent to

$$M(u) \leq M(x)^{\frac{y-u}{y-x}} M(y)^{\frac{u-x}{y-x}}$$

since the exponential function is increasing. Defining, therefore,

$$g(z) = M(x)^{\frac{y-z}{y-x}} M(y)^{\frac{z-x}{y-x}}$$

for $z \in \mathbb{C}$, we have an entire function. To see that this is the case, note first that $M(x) \geq 0$ by definition, being the supremum of magnitudes. Moreover, $M(x) = 0$ would imply $f(z) = 0$ on a vertical line, and so f would have a limit point of zeros, and hence be zero everywhere, but we assumed f not identically zero. Moreover $g(z) \neq 0$ for $z \in \mathbb{C}$.

Hence for $z = u + iv$,

$$|g(z)| = M(x)^{\frac{y-u}{y-x}} M(y)^{\frac{u-x}{y-x}},$$

which is the bound we are looking for. Now the right-hand side above is a continuous function in u from $[a, b]$ to $\mathbb{R}_{>0}$, and continuous functions send compact sets to compact sets, so the image must be a compact set in $\mathbb{R}_{>0}$, and hence the image cannot touch 0. Therefore $\frac{1}{|g(z)|}$ is bounded in \overline{G} , and so in turn $\frac{f(z)}{g(z)}$ is bounded in \overline{G} .

So for $z = x + iv$,

$$\frac{|f(z)|}{|g(z)|} = \frac{|f(x + iv)|}{M(x)} \leq 1,$$

since the bottom by definition is the supremum of the top, and similarly for $z = y + iv$,

$$\frac{|f(z)|}{|g(z)|} = \frac{|f(y + iv)|}{M(y)} \leq 1.$$

Hence by Lemma 11.1.1 $\frac{|f(z)|}{|g(z)|} \leq 1$ for $x < \operatorname{Re} z < y$, and so $|f(z)| \leq |g(z)|$ for all $z = u + iv$ with $x \leq u \leq y$. In other words

$$|f(u + iv)| \leq M(x)^{\frac{y-u}{y-x}} M(y)^{\frac{u-x}{y-x}}$$

and therefore

$$M(u) = \sup_{-\infty < v < \infty} |f(u + iv)| \leq M(x)^{\frac{y-u}{y-x}} M(y)^{\frac{u-x}{y-x}}. \quad \square$$

We showed, in the lemma, that if f is bounded by 1 on the boundary of G , then it is bounded by 1 inside G . The same sort of thing is true in more generality:

Corollary 11.1.2. *Let f and G be as in the Hadamard three-lines theorem. Then*

$$|f(z)| \leq \sup_{w \in \partial G} |f(w)|.$$

Proof. Let

$$M(x) = \sup_{-\infty < y < \infty} |f(x + iy)|.$$

By the Hadamard three-lines theorem, $\log M(x)$ is convex, and the maximum of a convex function occurs on the boundary, so

$$\log M(x) \leq \max\{\log M(a), \log M(b)\},$$

and taking exponentials $M(x) \leq \max\{M(a), M(b)\}$. \square

Lecture 12 Phragmén–Lindelöf Principle

12.1 Further generalising the maximum modulus principle

First let us establish a variant of the Hadamard three-lines theorem:

Theorem 12.1.1 (Hadamard three-circle theorem). *Let $0 < R_1 < R_2 < \infty$. Suppose f is analytic and not identically zero on the annulus $A = \{z \in \mathbb{C} \mid R_1 < |z| < R_2\}$. For $R_1 < r < R_2$, define*

$$M(r) = \max_{0 \leq \theta \leq 2\pi} |f(re^{i\theta})|.$$

Then for $R_1 < r_1 < r < r_2 < R_2$, we have

$$\log M(r) \leq \frac{\log r_2 - \log r}{\log r_2 - \log r_1} \log M(r_1) + \frac{\log r - \log r_1}{\log r_2 - \log r_1} \log M(r_2),$$

i.e., $\log M(r)$ is a convex function of $\log r$.

Proof. Noticing how the exponential function \exp maps vertical lines at real part $\log r$ to circles centred at the origin with radius r , as illustrated in Figure 12.1.1.

This result now follows immediately from the Hadamard three-lines theorem, since if we consider $g = f \circ \exp$, then $g(\log r + i\theta) = f(re^{i\theta})$. Hence

$$M(r) = \max_{0 \leq \theta \leq 2\pi} |f(re^{i\theta})| = \sup_{-\infty \leq \theta \leq \infty} |g(\log r + i\theta)|,$$

the logarithm of which is convex in $\log r$. \square

Exercise 12.1. Let f be analytic in an annulus $R_1 < |z| < R_2$ and not identically zero. Let

$$I_2(r) = \frac{1}{2\pi} \int_0^{2\pi} |f(re^{i\theta})|^2 d\theta$$

Show that $\log I_2(r)$ is a convex function of $\log r$ for $R_1 < r < R_2$.

Moreover, if f is a non-constant analytic function on $B(0; R)$, then $I_2(r)$ is strictly increasing. \blacksquare

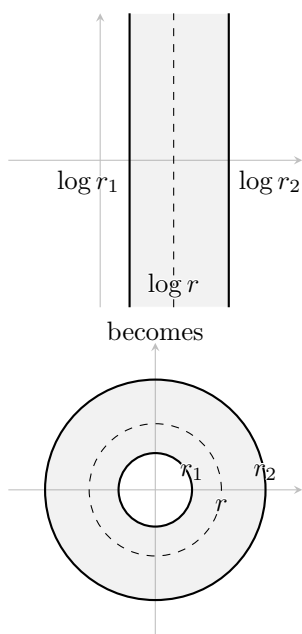

Figure 12.1.1: Transforming a vertical strip with \exp .

Exercise 12.2 ((A special case of) Hardy's theorem). Let f be a non-constant analytic function on $B(0; R)$. Show that

$$I(r) = \frac{1}{2\pi} \int_0^{2\pi} |f(re^{i\theta})| d\theta$$

is strictly increasing and $\log I(r)$ is a convex function of $\log r$. ■

Notice how Corollary 11.1.2 of the Hadamard three-lines theorem says that if a function f is bounded by M on vertical lines, then it is also bounded by M between the vertical lines.

In general, to use the Maximum modulus principle to draw such a conclusion, we would require boundedness also at infinity, since the vertical strip is unbounded. The following is a powerful generalisation of this:

Theorem 12.1.2 (Phragmén–Lindelöf principle). *Let G be a simply connected region. Let $f: G \rightarrow \mathbb{C}$ be an analytic function, and $\varphi: G \rightarrow \mathbb{C}$ be analytic and bounded in G and $\varphi(z) \neq 0$ for all $z \in G$.*

Suppose $\partial_\infty G = A \cup B$ such that

$$(i) \limsup_{z \rightarrow a} |f(z)| \leq M \text{ for all } a \in A, \text{ and}$$

$$(ii) \limsup_{z \rightarrow b} |\varphi(z)|^\eta |f(z)| \leq M \text{ for all } b \in B \text{ and all } \eta > 0 \text{ (in other words, } f \text{ isn't necessarily bounded on } B, \text{ but its growth is controlled by } \varphi).$$

Then $|f(z)| \leq M$ for all z in G .

Remark 12.1.3. In applications, one often takes $A = \partial G$ and $B = \{\infty\}$, so we only need to control growth at infinity, and on the usual boundary we are just bounded.

Proof. Let $|\varphi(z)| \leq K$ for all $z \in G$. Since G is simply connected and $\varphi(z) \neq 0$ for all $z \in G$, we can take $\varphi(z) = e^{h(z)}$ for some analytic function $h: G \rightarrow \mathbb{C}$. Now define $g(z) = e^{\eta h(z)}$ so that $|g(z)| = |\varphi(z)|^\eta$.

Consider the function $F: G \rightarrow \mathbb{C}$ defined by

$$F(z) = \frac{f(z)g(z)}{K^\eta},$$

which is analytic on G . We wish to use the Maximum modulus principle, and so we should check that $F(z)$ is bounded on $\partial_\infty G$, which by construction is $A \cup B$. To do this, first notice how

$$|F(z)| = \frac{|f(z)||g(z)|}{K^\eta} \leq \frac{|f(z)|K^\eta}{K^\eta} = |f(z)|,$$

so for $a \in A$,

$$\limsup_{z \rightarrow a} |F(z)| \leq \limsup_{z \rightarrow a} |f(z)| \leq M.$$

Similarly, for $b \in B$,

$$\limsup_{z \rightarrow b} |F(z)| = \limsup_{z \rightarrow b} \frac{|f(z)||g(z)|}{K^\eta} \leq \frac{1}{K^\eta} M$$

by choice of g . Hence by the Maximum modulus principle,

$$|F(z)| \leq \max\left\{M, \frac{M}{k^\eta}\right\}$$

for all $z \in G$, and therefore

$$|f(z)| \leq \frac{K^\eta}{|\varphi(z)|^\eta} \max\left\{M, \frac{M}{K^\eta}\right\}$$

for all $z \in G$ since $\varphi(z) \neq 0$. By taking $\eta \rightarrow 0$, this bound goes to M , and so $|f(z)| \leq M$ for all $z \in G$. \square

This gives us a general tool for bounding functions on unbounded domains, more powerful than the Maximum modulus principle since we no longer require boundedness at infinity, only some sufficiently good growth conditions.

For example, both as an example of how to use the theorem and the common practice of taking $B = \{\infty\}$ as mentioned in the remark:

Corollary 12.1.4. *Let G be the sector $G = \{z \mid |\arg z| < \frac{\pi}{2a}\}$ for $a \geq \frac{1}{2}$. Suppose f is analytic in G and there exists some $M > 0$ such that*

$$\limsup_{z \rightarrow w} |f(z)| \leq M$$

for all $w \in \partial G$. Suppose moreover there exists some $p > 0$ and $0 \leq b < a$ such that

$$|f(z)| \leq p \exp(|z|^b)$$

for all $z \in G$ with $|z|$ sufficiently large. Then $|f(z)| \leq M$ for all $z \in G$.

Remark 12.1.5. The corollary remains true if we replace G by any sector S of angle $\frac{\pi}{a}$. To see this, consider

$$g: G \xrightarrow{e^{i\theta}} S \xrightarrow{f} \mathbb{C},$$

i.e., $g(z) = f(e^{i\theta}z)$. Then $\sup|g(z)| = \sup|f(z)|$, and for a given f , we can choose θ such that g is in the original sector G of the same angle, and apply the corollary there.

Proof. Let $b < c < a$, and define $\varphi(z) = \exp(-z^c)$ for $z \in G$. Then $\varphi(z) \neq 0$ since it is an exponential function, and writing $z = re^{i\theta} \in G$ with $|\theta| < \frac{\pi}{2a}$ we have

$$\operatorname{Re}(z^c) = \operatorname{Re}(r^c e^{ic\theta}) = r^c \cos(c\theta).$$

Since $0 < c < a$ and $|\theta| < \frac{\pi}{2a}$, we have $|c\theta| < \frac{\pi}{2} \cdot \frac{c}{a} < \frac{\pi}{2}$, whence $\cos(c\theta) \geq \rho > 0$. This means that

$$\operatorname{Re}(-z^c) \leq -r^c \rho < 0,$$

which further gives us

$$|\varphi(z)| = \exp(\operatorname{Re}(-z^c)) \leq 1.$$

Hence for any $\eta > 0$, $z = re^{i\theta} \in G$, we have

$$|f(z)||\varphi(z)|^\eta \leq p \exp(|z|^b) \exp(-r^c \rho \eta) = p \exp(r^b - (\rho \eta)r^c).$$

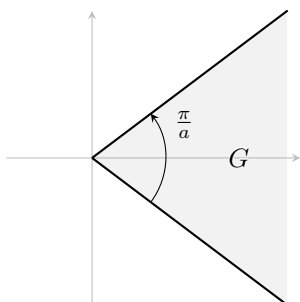

Figure 12.1.2: Sector G of angle $\frac{\pi}{a}$.

Since $c > b$ by choice, the second term in the exponential is dominant, so as $r \rightarrow \infty$ the inside goes to $-\infty$ and so the exponential as a whole goes to 0. Thus

$$\limsup_{|z| \rightarrow \infty} |f(z)| |\varphi(z)|^\eta = 0,$$

and hence by the Phragmén–Lindelöf principle,

$$|f(z)| \leq \max\{M, 0\} = M$$

for all $z \in G$. □

Remark 12.1.6. In this corollary, for a sector of angle $\frac{\pi}{a}$, we assume $|f(z)|$ is bounded by $\exp(|z|^b)$, specifically with $b < a$. If we take $b = a$, the corollary is still true, but the estimate needed is more subtle.

Looking at it, the key reason in our above proof where we use $b < a$ is to pick $b < c < a$, which in the end makes r^c the dominant term in $\exp(r^b - (\rho\eta)r^c)$. If $b = a (= c)$, by this argument we get $\exp((1 - \rho\eta)r^a)$, so for small η , this goes to infinity as $r \rightarrow \infty$.

Exercise 12.3. Let $G = \{z \mid \operatorname{Re}(z) > 0\}$ and let $f: G \rightarrow \mathbb{C}$ be analytic such that $f(1) = 0$. Suppose that

$$\limsup_{z \rightarrow w} |f(z)| \leq M$$

for $w \in \partial G$, and suppose that for every $\delta > 0$ with $0 < \delta < 1$, there is a constant P such that

$$|f(z)| \leq P \exp(|z|^{1-\delta})$$

for all $z \in G$. Prove that

$$|f(z)| \leq M \left(\frac{(1-x)^2 + y^2}{(1+x)^2 + y^2} \right)^{1/2},$$

for all $z = x + iy \in G$. ■

Corollary 12.1.7. Let $G = \{z \mid |\arg z| < \frac{\pi}{2a}\}$ for $a \geq \frac{1}{2}$. Suppose

$$\limsup_{z \rightarrow w} |f(z)| \leq M$$

for all $w \in \partial G$. Suppose for any $\delta > 0$ there exists a constant $p_\delta > 0$ such that

$$|f(z)| \leq p_\delta \exp(\delta|z|^a)$$

for all $z \in G$ with $|z|$ sufficiently large. Then $|f(z)| \leq M$ for all $z \in G$.

Proof. For any $\varepsilon > 0$, consider $F: G \rightarrow \mathbb{C}$ defined by

$$F(z) = f(z) \exp(-\varepsilon z^a).$$

Choose $0 < \delta < \varepsilon$ and $p_\delta > 0$ so that $|f(z)| \leq p_\delta \exp(\delta|z|^a)$. Then for any $x > 0$, $x \in \mathbb{R}$, we have

$$|F(x)| \leq p_\delta \exp((\delta - \varepsilon)x^a) \rightarrow 0$$

as $x \rightarrow \infty$ since $\delta - \varepsilon < 0$. The idea here is this: the original approach requires $|f(z)| \leq p \exp(|z|^b)$ with $b < a$, where the sector is of angle $\frac{\pi}{a}$, but we currently

have $b = a$. What we have just shown is that $F(z)$ is bounded on the positive real axis, so we can split our sector of angle $\frac{\pi}{a}$ into two sectors both of angle $\frac{\pi}{2a}$ —see Figure 12.1.3—where now $b = a < 2a$ permits us to use the previous result.

In other words, let $H_+ = \{z \mid 0 < \arg z < \frac{\pi}{2a}\}$ and $H_- = \{z \mid -\frac{\pi}{2a} < \arg z < 0\}$, and let

$$M_1 := \sup_{0 < x < \infty} |F(x)| < \infty$$

since by the above discussion $F(x)$ is bounded at infinity, and define $M_2 = \max\{M_1, M\}$.

Then for $w \in \partial H_+$ or $w \in \partial H_-$ we have

$$\limsup_{z \rightarrow w} |F(z)| \leq M_2$$

since it is bounded by M on the original boundary and by M_1 on the real axis. Hence by Corollary 12.1.4 and Remark 12.1.5 about how it works for any sector, $|F(z)| \leq M_2$ for all $z \in H_+$ and $z \in H_-$, and hence $|F(z)| \leq M_2$ for all $z \in G$.

Finally, we claim that $M_2 = M$, i.e., $M \geq M_1$. To see this, suppose $M < M_1$. Then there exists some $x \in \mathbb{R}$ such that $|F(x)| \geq |F(z)|$ for all $z \in G$, in other words $F(z)$ attains its maximum in the interior of G . The Maximum modulus principle then implies $F(z)$ is constant, which is a contradiction.

Hence $|F(z)| \leq M$ for all $z \in G$, and therefore $|f(z)| \exp(-\varepsilon z^a) \leq M$, implying in the end

$$|f(z)| \leq M \exp(\varepsilon z^a)$$

which as $\varepsilon \rightarrow 0$ goes to M . \square

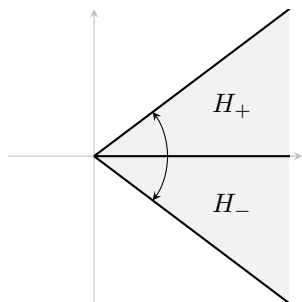

Figure 12.1.3: Splitting sector G into halves of angle $\frac{\pi}{2a}$.

Lecture 13 The Space of Analytic Functions

13.1 The topology of $C(G, \mathbb{C})$

For the proceeding discussion we need some results analysis.

Proposition 13.1.1. *Let $G \subset \mathbb{C}$ be open. Then there exists a sequence $\{K_n\}$ of compact subsets of G such that $G = \bigcup_{n=1}^{\infty} K_n$ satisfying*

- (i) $K_n \subset \text{int}(K_{n+1})$;
- (ii) if $K \subset G$ is compact, then $K \subset K_n$ for some n ; and
- (iii) every component of $\mathbb{C}_{\infty} \setminus K_n$ contains a component of $\mathbb{C}_{\infty} \setminus G$.

Sketch of proof. Since G is open, we can define K_n to be the set of all points in G at least $1/n$ away from the boundary of G . That is,

$$K_n = \left\{ z \in G \mid |z - w| \geq \frac{1}{n} \text{ for all } w \in \mathbb{C} \setminus G \right\}.$$

This construction satisfies all of these conditions. \square

Definition 13.1.2 (Continuous functions). Let Ω be \mathbb{C} or \mathbb{C}_∞ . We define

$$C(G, \Omega) = \{ f: G \rightarrow \Omega \mid f \text{ is continuous on } G \},$$

the set of *continuous* from G to Ω .

Remark 13.1.3. Note that in principle this only requires G and Ω to be metric spaces—we are specifying for the purpose of doing complex analysis.

Denote the metric on Ω by d (so if $\Omega = \mathbb{C}$, then $d(z_1, z_2) = |z_1 - z_2|$. The metric on the Riemann sphere \mathbb{C}_∞ we will talk more about later).

If G is an open set, then by Proposition 13.1.1 we can write $G = \bigcup_{n=1}^{\infty} K_n$ for a sequence of compact sets K_n . For f and g in $C(G, \Omega)$ we define

$$\rho_n(f, g) = \sup_{z \in K_n} d(f(z), g(z))$$

for all $n \in \mathbb{N}$, and further define

$$\rho(f, g) = \sum_{n=1}^{\infty} \left(\frac{1}{2} \right)^n \frac{\rho_n(f, g)}{1 + \rho_n(f, g)}.$$

Then $(C(G, \Omega), \rho)$ is a metric space. (That ρ is a metric follows from $\frac{d(x, y)}{1 + d(x, y)}$ being a metric for any metric d , and since this is bounded above by 1, the series above is bounded above by a convergent geometric series.)

Lemma 13.1.4. (i) Given $\varepsilon > 0$, there exists $\delta > 0$ and a compact set $K \subset G$ such that for $f, g \in C(G, \Omega)$,

$$\sup_{z \in K} d(f(z), g(z)) < \delta$$

implies $\rho(f, g) < \varepsilon$.

(ii) Given a $\delta > 0$ and compact set $K \subset G$, there exists $\varepsilon > 0$ such that for $f, g \in C(G, \Omega)$, $\rho(f, g) < \varepsilon$ implies

$$\sup_{z \in K} d(f(z), g(z)) < \delta.$$

In other words, if f and g are close in some compact set K (or K_n in particular), then they are close in the sense of ρ , and vice versa.

Remark 13.1.5. This lemma says that $f_n \rightarrow f$ in $(C(G, \Omega), \rho)$ if and only if $f_n \rightarrow f$ is uniformly convergent (because of the supremum) on every compact subset K of G .

Proposition 13.1.6. The space $(C(G, \Omega), \rho)$ is a complete metric space.

Proof. A sequence of continuous functions converging uniformly must have a continuous limit. This is a consequence of this fact. \square

13.2 The space of analytic functions

In particular we are interested not just in the continuous functions from G to \mathbb{C} , but the continuous and differentiable ones, i.e., the analytic functions from G to \mathbb{C} .

That is to say, let $G \subset \mathbb{C}$ be open, and let

$$H(G) := \{ f: G \rightarrow \mathbb{C} \mid f \text{ is analytic on } G \}.$$

Then $H(G) \subset C(G, \mathbb{C})$ can be endowed with the subspace topology.⁵

Theorem 13.2.1. *Let $\{f_n\} \subset H(G)$. Suppose $f_n \rightarrow f$ for some $f \in C(G, \mathbb{C})$. Then $f \in H(G)$ and $f_n^{(k)} \rightarrow f^{(k)}$ for all $k \geq 1$.*

In other words, $H(G)$ is a closed subset of $C(G, \mathbb{C})$.

Remark 13.2.2. This result does not hold in the real case. For example, if $f_n(x) = \frac{1}{n}x^n$ on $x \in [0, 1]$, then $f_n \rightarrow f = 0$ uniformly in $[0, 1]$, but $f'_n(x) = x^{n-1}$ does not converge at all in the space of continuous functions (the pointwise limit exists, but is not continuous).

Lecture 14 Compactness in $H(G)$

14.1 Compactness in the space of analytic functions

Proof of Theorem 13.2.1. For the first part, that the limit $f_n \rightarrow f$ is analytic, note that differentiability is a local property, so it suffices for $z \in G$ to consider $B(a, r) \subset G$. Then for any triangular path $T \subset B(z, r)$,

$$\int_T f(z) dz = \lim_{n \rightarrow \infty} \int_T f_n(z) dz$$

since $f_n \rightarrow f$ uniformly on compact sets, say $\overline{B(z, r)}$ (take a slightly smaller r if necessary). Now all f_n are analytic by assumption, so the integral is 0. Hence by Morera's theorem f is analytic.

For the second part, again take $B(z, r) \subset G$, and let γ be the circle $|w - z| = r$. By Cauchy's formula,

$$f_n^{(k)}(z) - f^{(k)}(z) = \int_\gamma \frac{f_n(w) - f(w)}{(w - z)^{k+1}} dw.$$

Since $f_n \rightarrow f$ uniformly on $\overline{B(z, r)}$, we can choose, for any $\varepsilon > 0$, n large enough so that $|f_n(w) - f(w)| < \varepsilon$ for all $w \in \overline{B(z, r)}$. Hence

$$|f_n^{(k)}(z) - f^{(k)}(z)| \leq \int_\gamma \frac{\varepsilon}{r^{k+1}} dw \leq \varepsilon r^{-(k+1)} (2\pi r),$$

which we can hence make arbitrarily small, so $f_n^{(k)} \rightarrow f^{(k)}$. □

Immediately from this we have:

⁵We call this space H for *holomorphic*, which in the case of complex functions is equivalent to being analytic.

Corollary 14.1.1. $H(G)$ is a complete metric space.

Proof. It is a closed subset of a complete metric space, hence itself complete. \square

Corollary 14.1.2. Let $\{f_n\} \subset H(G)$. Suppose

$$\sum_{n=1}^{\infty} f_n(z)$$

converges uniformly on compact subsets to $f(z)$. Then

$$f^{(k)}(z) = \sum_{n=1}^{\infty} f_n^{(k)}(z).$$

In other words, we can take derivatives term by term.

Exercise 14.1. Let f, f_1, f_2, \dots be elements of $H(G)$. Show that $f_n \rightarrow f$ in $H(G)$ if and only if for each closed rectifiable curve γ in G , $f_n(z) \rightarrow f(z)$ uniformly for z in $\{\gamma\}$. \blacksquare

It is instructive to remark that this is not true in the real case: the special structure of complex analytic functions that make this work is that, in the case of complex functions, the derivatives of a function f are controlled by f itself.

Theorem 14.1.3 (Hurwitz's theorem). Let G be a region, and let $\{f_n\} \subset H(G)$ be a convergent sequence, so $f_n \rightarrow f \in H(G)$. Suppose $f \neq 0$ on $\overline{B(a, R)} \subset G$ and $f(z) \neq 0$ on $|z - a| = R$. Then there exists some $N \in \mathbb{N}$ such that for $n \geq N$, f_n and f have the same number of zeros in $B(a, R)$.

Proof. Since $f(z) \neq 0$ on $|z - a| = R$, which is a compact set, we must have $\delta := \inf_{|z-a|=R} |f(z)| > 0$. Since $f_n \rightarrow f$ uniformly on $|z - a| = R$, there exists some $N \in \mathbb{N}$ such that for $n \geq N$ and $|z - a| = R$, $f_n(z) \neq 0$, since it is close to f , which is at least δ away from 0.

So on $|z - a| = R$,

$$|f_n(z) - f(z)| < \frac{\delta}{2} < |f(z)|,$$

which by Rouché's theorem means f_n and f have the same number of zeros in $B(a, R)$. \square

Corollary 14.1.4. Let G be a region. Let $\{f_n\} \subset H(G)$ and $f_n \rightarrow f \in H(G)$. Suppose $f_n(z) \neq 0$ for all $z \in G$ and all $n \in \mathbb{N}$. Then either $f = 0$ or $f(z) \neq 0$ for all $z \in G$.

Exercise 14.2. Let $\{f_n\} \subset H(G)$ be a sequence of one-to-one functions. Suppose $f_n \rightarrow f$ in $H(G)$. Show that either f is one-to-one or f is a constant function. \blacksquare

14.2 Montel's theorem

In order to do the following discussion justice we need to recall some information from functional analysis.

First of all, if (M, d) is a metric space, then there are several equivalent notions of compactness. In particular, M is compact (in the sense of every open cover having a finite subcover) if and only if M is sequentially compact (i.e., every bounded sequence has a convergent subsequence), if and only if M is limit point compact (meaning every infinite set has a limit point).

Recall how in \mathbb{R}^n or \mathbb{C}^n (or in fact any finite dimensional vector space), a set is compact if and only if it is closed and bounded. In general, this is not enough:

Definition 14.2.1 (Equicontinuity). A family of functions \mathcal{F} in a metric space (M, d) is **equicontinuous** if for every $\varepsilon > 0$ there exists a $\delta > 0$ so that $d(f(x), f(y)) < \varepsilon$ for all $f \in \mathcal{F}$ and $d(x, y) < \delta$.

In other words, it is the usual definition of continuity, except that for a given $\varepsilon > 0$, the *same* $\delta > 0$ works for every $f \in \mathcal{F}$ at once.

Theorem 14.2.2 (Arzelà–Ascoli theorem). *Let (M, d) be a compact metric space, and let $C(M) = \{f: M \rightarrow \mathbb{R} \text{ or } \mathbb{C} \mid f \text{ is continuous}\}$. A family $\mathcal{F} \subset C(M)$ is compact if and only if \mathcal{F} is closed, bounded, and equicontinuous.*

Definition 14.2.3 (Normal). Let $G \subset \mathbb{C}$ be open and $\Omega = \mathbb{C}$ or $\Omega = \mathbb{C}_\infty$. A set $\mathcal{F} \subset C(G, \Omega)$ is **normal** if every sequence in \mathcal{F} has a subsequence which converges to a function $f \in C(G, \Omega)$.

Note how this is different from sequential compactness—the limit f of the convergent subsequence need not be in \mathcal{F} .

Exercise 14.3. A set $\mathcal{F} \subset C(G, \Omega)$ is normal if and only if its closure is compact. ■

Exercise 14.4. (a) Let f be an analytic function on an open neighbourhood of $\overline{B(a; R)}$. Show that

$$|f(a)|^2 \leq \frac{1}{\pi R^2} \int_0^{2\pi} \int_0^R |f(a + re^{i\theta})|^2 r \, dr \, d\theta.$$

(b) Let G be a region and let $M > 0$ be a fixed constant. Let \mathcal{F} be the family of all functions f in $H(G)$ such that $\iint_G |f(z)|^2 \, dx \, dy \leq M$. Show that \mathcal{F} is normal. ■

Remark 14.2.4. This problem implies the following: Let $f, f_n \in H(G)$. If $f_n \rightarrow f$ in $L^2(G)$, then $f_n \rightarrow f$ in $H(G)$.

In other words, L^2 convergence for analytic functions implies uniform convergence on compact subsets. The same is true for L^1 convergence, as it happens, though neither are true for real analytic functions:

Exercise 14.5. Let $f, f_n \in H(G)$. Suppose $f_n \rightarrow f$ in $L^1(G)$, i.e., $\iint_G |f_n(z) - f(z)| \, dx \, dy \rightarrow 0$. Show that $f_n \rightarrow f$ in $H(G)$. ■

So in $C(G, \mathbb{C})$, compact means closed, bounded, and equicontinuous. The question we are looking to answer with this discussion is how we would similarly characterise compact sets in $H(G)$. In other words, what does it mean to be normal in $H(G)$?

Definition 14.2.5 (Locally bounded). A set $\mathcal{F} \subset H(G)$ is **locally bounded** if for each $a \in G$ there exists some $M > 0$ and $r > 0$ so that for every $f \in \mathcal{F}$, $|f(z)| \leq M$ for all $z \in B(a, r)$.

In other words, for each $a \in G$, there exists $r > 0$ such that

$$\sup_{\substack{z \in B(a, r) \\ f \in \mathcal{F}}} |f(z)| < \infty,$$

or, as a final way of putting it, for every $a \in G$ there exists $r > 0$ such that \mathcal{F} is uniformly bounded in $B(a, r)$.

It follows more or less from this definition that:

Lemma 14.2.6. *A set $\mathcal{F} \subset H(G)$ is locally bounded if and only if \mathcal{F} is uniformly bounded on every compact subset $K \subset G$.*

Theorem 14.2.7 (Montel's theorem). *A family $\mathcal{F} \subset H(G)$ is normal if and only if \mathcal{F} is locally bounded.*

Proof. For the forward direction, suppose \mathcal{F} is not locally bounded, i.e., there exists some compact subset $K \subset G$ such that

$$\sup_{\substack{z \in K \\ f \in \mathcal{F}}} |f(z)| = \infty.$$

So there exists some $\{f_n\} \subset \mathcal{F}$ such that $\sup_{z \in K} |f_n(z)| \geq n$. Since \mathcal{F} is normal, $\{f_n\}$ has a convergent subsequence $\{f_{n_k}\}$, say $f_{n_k} \rightarrow f \in H(G)$ (nominally $C(G, \mathbb{C})$, but $H(G)$ is closed, we showed). Since K is compact and f is continuous,

$$\sup_{z \in K} |f(z)| = M < \infty.$$

Hence

$$\begin{aligned} n_k &\leq \sup_{z \in K} |f_{n_k}(z)| \leq \sup_{z \in K} |f_{n_k}(z) - f(z)| + \sup_{z \in K} |f(z)| \\ &= \sup_{z \in K} |f_{n_k}(z) - f(z)| + M \end{aligned}$$

where the right-hand side approaches M as $n_k \rightarrow \infty$ since $f_{n_k} \rightarrow f$ uniformly on K , but the left-hand side goes to infinity, which is a contradiction.

For the converse direction, let $K \subset G$ be compact. We claim that when \mathcal{F} restricts to $(C(K), \|\cdot\|_\infty)$, every sequence in $\overline{\mathcal{F}}$ has a convergent subsequence in $C(K)$.

To prove this, by the Arzelà–Ascoli theorem, we need to show that $\overline{\mathcal{F}}$ is closed, bounded, and equicontinuous. That it is closed in $(C(K), \|\cdot\|_\infty)$ is clear: it is a closure. Since \mathcal{F} is locally bounded, it is uniformly bounded on K , being compact, so $\overline{\mathcal{F}}$ is also uniformly bounded on K . Hence $\overline{\mathcal{F}}$ is bounded in $(C(K), \|\cdot\|_\infty)$.

It remains to show that it is equicontinuous. Since \mathcal{F} is locally bounded, for each $a \in G$ there exists $r > 0$ and $M > 0$ such that $|f(z)| \leq M$ for every $z \in \overline{B(a, r)}$ and every $f \in \mathcal{F}$. For $z \in B(a, \frac{r}{2})$, by Cauchy's integral formula,

$$\begin{aligned} |f(a) - f(z)| &= \frac{1}{2\pi} \left| \int_{\gamma} \frac{f(w)}{w-a} - \frac{f(w)}{w-z} dw \right| \\ &= \frac{1}{2\pi} \left| \int_{\gamma} \frac{f(w)(a-z)}{(w-a)(w-z)} dw \right| \\ &\leq \frac{1}{2\pi} \int_{\gamma} \frac{M|a-z|}{r \cdot \frac{r}{2}} |dw| \leq \frac{1}{\pi} \frac{M}{r^2} 2\pi r |a-z|, \end{aligned}$$

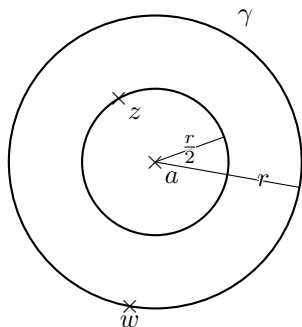

Figure 14.2.1: Schematic of w and z .

where the constant in front of $|a-z|$ does not depend on f . Hence \mathcal{F} is uniformly Lipschitz, and hence equicontinuous, and so finally $\overline{\mathcal{F}}$ is equicontinuous, finishing the claim.

Finally, to finish the theorem, write $G = \bigcup_{n=1}^{\infty} K_n$ as in Proposition 13.1.1.

For any $\{f_n\} \subset \mathcal{F} \subset \overline{\mathcal{F}}$, by the claim, when $\{f_n\}$ restricts to K_1 , it has a convergent subsequence, say $\{f_{n_k^1}\}$ in $H(K_1)$.

Now consider $\{f_{n_k^1}\}$ restricted to K_2 —it has a convergent subsequence $\{f_{n_k^2}\}$ in $H(K_2)$, and so on, with $\{f_{n_k^m}\}$ being convergent in $H(K_m)$.

Take the diagonal $\{f_{n_k^k}\} \subset \{f_n\}$. Then $\{f_{n_k^k}\}$ converges uniformly when restricted to any compact set $K \subset G$, so $f_{n_k^k} \rightarrow f$ in $H(G)$, meaning that \mathcal{F} is normal. \square

This lets us answer our question:

Corollary 14.2.8. *A set $\mathcal{F} \subset H(G)$ is compact if and only if \mathcal{F} is closed and locally bounded.*

Lecture 15 The Space of Meromorphic Functions

15.1 The topology of $C(G, \mathbb{C}_{\infty})$

Recall how we model the Riemann sphere $\mathbb{C}_{\infty} = \mathbb{C} \cup \{\infty\}$ as a sphere centred on the origin of the origin of the complex plane, and we identify the north pole of the sphere as ∞ , and if we imagine a line connecting this north pole with any given point z on the complex plane, where this line intersects the sphere, say Z , is the corresponding point. We have illustrated this in Figure 15.1.1.

If we wish to study continuous functions from G to \mathbb{C}_{∞} , we first need a metric on \mathbb{C}_{∞} . We define this metric d by

$$d(z_1, z_2) = d(Z_1, Z_2)$$

for $z_1, z_2 \in \mathbb{C}$, where Z_1 and Z_2 are the points corresponding to z_1 and z_2 on the sphere, and the right-hand side distance is measured in the usual Euclidean way in \mathbb{R}^3 .

Then in all, we define the metric on \mathbb{C}_{∞} by

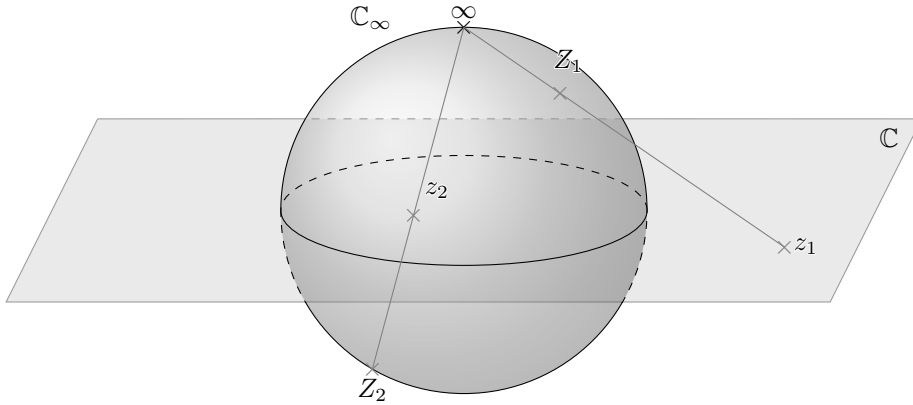

Figure 15.1.1: A model of the Riemann sphere, identifying points $z_1, z_2 \in \mathbb{C}$ with points $Z_1, Z_2 \in \mathbb{C}_\infty$.

- (i) if $z_1, z_2 \in \mathbb{C}$, then $d(z_1, z_2) = \frac{2|z_1 - z_2|}{(1 + |z_1|^2)^{1/2}(1 + |z_2|^2)^{1/2}}$ (this is just $d(Z_1, Z_2)$ written out); and
- (ii) if $z \in \mathbb{C}$, then $d(z, \infty) = \frac{2}{(1 + |z|^2)^{1/2}}$.

This metric has an interesting property: for $z_1, z_2 \neq 0$,

$$d(z_1, z_2) = d\left(\frac{1}{z_1}, \frac{1}{z_2}\right),$$

and similarly for $z \neq 0$,

$$d(z, 0) = d\left(\frac{1}{z}, \infty\right).$$

This is a consequence of z and $1/z$ corresponding to symmetric points in the upper and lower hemispheres in this model.

Remark 15.1.1. In order to distinguish the topology on the complex plane and the topology on the Riemann sphere, we will (as before) use $B(a, r)$ to mean an open ball in $(\mathbb{C}, |\cdot|)$, and $B_\infty(a, r)$ to mean a ball in the Riemann sphere (\mathbb{C}_∞, d) .

The good news is that these topologies are essentially the same (barring the tricky point at infinity):

- Proposition 15.1.2.** (i) Given $a \in \mathbb{C}$ and $r > 0$, there exists $\rho > 0$ such that $B_\infty(a, \rho) \subset B(a, r)$ (so open in $|\cdot|$ implies open in d);
- (ii) Given $a \in \mathbb{C}$ and $\rho > 0$, there exists $r > 0$ such that $B(a, r) \subset B_\infty(a, \rho)$ (so open in d implies open in $|\cdot|$);
- (iii) Given $\rho > 0$, there exists a compact set $K \subset \mathbb{C}$ such that $\mathbb{C}_\infty \setminus K \subset B_\infty(\infty, \rho)$; and
- (iv) Given a compact set $K \subset \mathbb{C}$, there exists $\rho > 0$ such that $B_\infty(\infty, \rho) \subset \mathbb{C}_\infty \setminus K$.

Remark 15.1.3. Parts (i) and (ii) together imply that the subspace topology on $\mathbb{C} \subset \mathbb{C}_\infty$ and the usual topology $(\mathbb{C}, |\cdot|)$ are the same. In other words, things will converge in one if and only if they converge in the other (though the speed of convergence needn't be the same).

Parts (iii) and (iv) tell us that \mathbb{C}_∞ is, in fact, a one-point compactification of \mathbb{C} .

Recall how a function $f: G \rightarrow \mathbb{C}$ is called *meromorphic* if it is analytic except for isolated poles. Now that we have a metric on the Riemann sphere, we can view this in a different light: a meromorphic function is an analytic function (hence continuous) which sometimes reaches infinity. In other words, $f: G \rightarrow \mathbb{C}_\infty$ is continuous.

In this light, if we let $M(G)$ denote the set of all meromorphic functions on G , then $M(G) \subset C(G, \mathbb{C}_\infty)$, where $C(G, \mathbb{C}_\infty)$ is a complete metric space in d .

Remark 15.1.4. Unlike $H(G)$, the space $M(G)$ of meromorphic functions is *not* complete, for it is not closed.

For example, if we let $f_n(z) = n$ be constant functions, then $\{f_n\}$ is a Cauchy sequence in $C(G, \infty)$ (they get close to ∞), and $f_n \rightarrow f$ where $f \equiv \infty$. But this limit is not meromorphic.

It is instructive to note that this does not converge at all in $C(G, \mathbb{C})$ —convergence in $C(G, \mathbb{C}_\infty)$ is not quite the same. This example then also demonstrates that in $C(G, \mathbb{C}_\infty)$, $H(G)$ also stops being closed.

That said, $M(G)$ is, in some sense, very close to being complete: the *only* function it is missing is the one that is constantly infinity:

Theorem 15.1.5. (i) Let $\{f_n\} \subset M(G)$. Suppose $f_n \rightarrow f$ in $C(G, \mathbb{C}_\infty)$. Then either $f \in M(G)$ or $f \equiv \infty$.

(ii) Suppose $\{f_n\} \subset H(G)$ and $f_n \rightarrow f$ in $C(G, \mathbb{C}_\infty)$. Then either $f \in H(G)$ or $f \equiv \infty$.

Consequently,

Corollary 15.1.6. $\overline{M(G)} = M(G) \cup \{\infty\}$ is a complete metric space.

Corollary 15.1.7. $\overline{H(G)} = H(G) \cup \{\infty\}$ is a closed in $C(G, \mathbb{C}_\infty)$ and hence complete.

Lecture 16 Compactness in $M(G)$

16.1 Compactness in the space of meromorphic functions

Before moving on, let us take a step back and prove Theorem 15.1.5 from the end of last lecture.

Proof. (i) Let $a \in G$. Since f is a function in $C(G, \mathbb{C}_\infty)$, there are essentially two cases on hand: either $f(a)$ is finite or $f(a) = \infty$.

Let us start with the first one: assume $f(a) \neq \infty$. Since $f_n \rightarrow f$ in $C(G, \mathbb{C}_\infty)$, meaning $f_n(z) \rightarrow f(z)$ uniformly on compact subsets of G , we have in particular

$d(f_n(z), f(z)) \rightarrow 0$ uniformly on $\overline{B(a, r)} \subset G$. By Proposition 15.1.2, restricting d to \mathbb{C} becomes the usual topology on \mathbb{C} , so $|f_n(z) - f(z)| \rightarrow 0$ uniformly on $\overline{B(a, r)}$.

Notice how the set $S = \{f, f_1, f_2, \dots\} \subset C(G, \mathbb{C}_\infty)$ is compact (since it is sequentially compact), and hence it is equicontinuous, since the Arzelà–Ascoli theorem tells us compact is equivalent with closed, bounded, and equicontinuous.

Therefore given any $\varepsilon > 0$ there exists $r_1 < r$ such that $d(f_n(z), f_n(a)) < \varepsilon$ for all $z \in B(a, r_1)$ and all $n \in \mathbb{N}$. Again by Proposition 15.1.2, there then exists some $\rho > 0$ such that $|f_n(z) - f_n(a)| < \frac{1}{2}\rho$ for all $z \in B(a, r_1)$ and all $n \in \mathbb{N}$.

On the other hand, $f_n(a) \rightarrow f(a)$ means that there exists some $N \in \mathbb{N}$ such that for $n \geq N$, $|f_n(a) - f(a)| < \frac{1}{2}\rho$. Putting these together, the triangle inequality tells us that for $n \geq N$ and $z \in B(a, r_1)$,

$$|f_n(z)| \leq |f_n(z) - f_n(a)| + |f_n(a) - f(a)| + |f(a)| \leq \frac{1}{2}\rho + \frac{1}{2}\rho + |f(a)| < \infty.$$

So the set $\{f_n\}_{n \geq N}$ is uniformly bounded on $B(a, r_1)$, and hence those f_n are analytic, not just meromorphic, on $B(a, r_1)$ (since boundedness means they cannot get close to infinity, so can't have poles there). We already know (Corollary 14.1.1) that $H(G)$ is a complete metric space, so f_n being analytic means their limit f must be too, so f is analytic on $B(a, r_1)$.

This leaves the case where $f(a) = \infty$. In other words, $f(a)$ has a pole at $z = a$. We need to show that it is isolated.

To this end, define

$$g_n(z) = \begin{cases} \frac{1}{f_n(z)}, & \text{if } f_n(z) \neq 0, \\ \infty, & \text{if } f_n(z) = 0. \end{cases}$$

Since $d(z_1, z_2) = d(\frac{1}{z_1}, \frac{1}{z_2})$ and $f_n \rightarrow f$, we consequently have $g_n \rightarrow \frac{1}{f}$ in $C(G, \mathbb{C}_\infty)$.

Now since $\frac{1}{f(a)} = 0$, not infinity, the first case we considered tells us that $f_n(z)$ and $\frac{1}{f(z)}$ are analytic on a ball $B(a, r) \subset G$ for some $n \geq N$ sufficiently large. By Hurwitz's theorem, either $\frac{1}{f}$ is identically zero or $\frac{1}{f(z)}$ has the same number of zeros as $g_n(z)$ in $B(a, r)$, for n sufficiently large. This in turn implies that $f \equiv \infty$ or f has isolated poles (since its poles are zeros of $\frac{1}{f}$, and it has as many zeros as $g_n(z)$ in $B(a, r)$, and those zeros must be isolated, being analytic).

(ii) Assume $\{f_n\} \subset H(G)$. Then, since f_n has no poles, $\frac{1}{f_n}$ has no zeros. Since $f_n \rightarrow f$, we then have $\frac{1}{f_n} \rightarrow \frac{1}{f}$ in $C(G, \mathbb{C}_\infty)$, which in turn means $\frac{1}{f_n(z)} \rightarrow \frac{1}{f(z)}$ uniformly on $\overline{B(a, r)}$ (in both $C(G, \mathbb{C}_\infty)$ and $C(G, \mathbb{C})$).

By the first case above, all $\frac{1}{f_n}$ are analytic for n large enough, so by Hurwitz's theorem either $\frac{1}{f} \equiv 0$ or $\frac{1}{f}$ and $\frac{1}{f_n}$ have the same number of zeros in $B(a, r)$ for n sufficiently large.

But $\frac{1}{f_n}$ has no zeros, meaning that either $\frac{1}{f} \equiv 0$ or $\frac{1}{f(z)} \neq 0$ for all $z \in B(a, r)$. The first situation means $f \equiv \infty$, and the second situation means f has no poles, so $f(z)$ is analytic on $B(a, r)$. \square

With this out of the way we are ready to start answering our main question in this recent discussion: how do we classify normal families in $M(G)$?

It is instructive at this point to recall what we did in the case of $H(G)$, namely Montel's theorem. The culmination of our argument in showing that our family was equicontinuous was to instead show that it is uniformly Lipschitz, and to demonstrate this we showed that the derivatives f' are uniformly bounded.

The reason for this, of course, is that if we wish to show that $|f(z) - f(a)|$ is small when $|z - a|$ is small, we can instead show that their quotient is bounded (i.e., f is Lipschitz), but their quotient is a good approximation of $f'(a)$, so we can instead show that the derivative is bounded.

This is our approach also in the case of meromorphic functions, except now the metric we need to reconcile isn't $|\cdot|$, but d , and hence we need another way of approximating the notion of continuity in terms of some kind of derivative.

Definition 16.1.1. Let $f \in M(G)$, and define $\mu(f): G \rightarrow \mathbb{R}$ by

$$\mu(f)(z) = \frac{2|f'(z)|}{1 + |f(z)|^2}$$

if z is not a pole of f , and

$$\mu(f)(a) = \lim_{z \rightarrow a} \frac{2|f'(z)|}{1 + |f(z)|^2}$$

if $z = a$ is a pole of f .

The motivation is already outlined above, but concretely, this is because $d(f(z), f(w))$ is well approximated by $\mu(f)(z)|z - w|$.

Consequently, if $\mu(f)$ is bounded, then f is Lipschitz, and so if $\mu(f)$ is uniformly bounded for all $f \in \mathcal{F}$, then \mathcal{F} is uniformly Lipschitz.

That said, we ought to first make sure this $\mu(f)$ makes sense at all. In particular, is it well-defined? Does the limit in the case of $z = a$ being a pole exist?

Suppose $z = a$ is a pole of order m of f . It has a Laurent expansion

$$f(z) = \frac{A_m}{(z-a)^m} + \cdots + \frac{A_1}{z-a} + g(z),$$

where $A_m \neq 0$ and $g(z)$ is analytic. Then

$$f'(z) = -\left(\frac{mA_m}{(z-a)^{m+1}} + \cdots + \frac{A_1}{(z-a)^2}\right) + g'(z),$$

meaning that

$$\begin{aligned} \frac{2|f'(z)|}{1 + |f(z)|^2} &= \frac{2\left|\frac{mA_m}{(z-a)^{m+1}} + \cdots + \frac{A_1}{(z-a)^2} - g'(z)\right|}{1 + \left|\frac{A_m}{(z-a)^m} + \cdots + \frac{A_1}{z-a} + g(z)\right|^2} \\ &= \frac{2|z-a|^{m+1}|mA_m + \cdots + A_1(z-a)^{m-1} - g'(z)(z-a)^{m+1}|}{|z-a|^{2m} + |A_m + \cdots + A_1(z-a)^{m-1} + g(z)(z-a)^m|^2}. \end{aligned}$$

Hence if $m \geq 2$, then

$$\lim_{z \rightarrow a} \frac{2|f'(z)|}{1 + |f(z)|^2} = \frac{0}{A_m} = 0,$$

and if $m = 1$, then

$$\lim_{z \rightarrow a} \frac{2|f'(z)|}{1 + |f(z)|^2} = \frac{2|A_1|}{|A_1|^2} = \frac{2}{|A_1|}.$$

Hence $\mu(f)(z) \in \mathbb{R}$ for all $z \in G$ and is well-defined, and moreover by construction $\mu(f) \in C(G, \mathbb{R})$.

Theorem 16.1.2. *A set $\mathcal{F} \subset M(G)$ is normal in $C(G, \mathbb{C}_\infty)$ if and only if $\mu(\mathcal{F}) = \{\mu(f) \mid f \in \mathcal{F}\}$ is locally bounded.*

Before we go on to prove this, it is instructive to compare this to our approach in the case of $H(G)$ again. As previously discussed, we ended up showing that \mathcal{F}' is locally bounded in this case, except in the end our characterisation was \mathcal{F} is normal if and only if \mathcal{F} is locally bounded. The reason for this is that the derivative of an analytic function is controlled by the function itself—the salient part of the proof is still \mathcal{F}' being locally bounded, it just so happens that $\mathcal{F} \subset H(G)$ being locally bounded implies \mathcal{F}' is locally bounded.

Exercise 16.1. Show that if $\mathcal{F} \subset H(G)$ is normal, then $\mathcal{F}' := \{f' \mid f \in \mathcal{F}\}$ is also normal. Is the converse true? Can you add something to the hypothesis that \mathcal{F}' is normal to insure that \mathcal{F} is normal? ■

With this in mind, it should come as no great surprise that the proof, whilst in parts a bit technical, is closely related to our proof of Montel's theorem.

Proof. For the forward direction, suppose $\mu(\mathcal{F})$ is not locally bounded. Then there exists $\{f_n\} \subset \mathcal{F}$ and a compact subset $K \subset G$ such that

$$\sup_{z \in K} |\mu(f_n)(z)| \geq n.$$

Since \mathcal{F} is normal, there exists some convergent subsequence $\{f_{n_k}\} \subset \{f_n\}$ such that $f_{n_k} \rightarrow f$ in $C(G, \mathbb{C}_\infty)$, and in particular the convergence is uniform on compact subsets (such as K !). Hence $\mu(f_{n_k}) \rightarrow \mu(f)$ in $C(G, \mathbb{R})$. Therefore

$$n_k \leq \sup_{z \in K} |\mu(f_{n_k})(z)| \leq \sup_{z \in K} |\mu(f_{n_k})(z) - \mu(f)(z)| + \sup_{z \in K} |\mu(f)(z)|.$$

The left-hand side evidently goes to infinity as $n_k \rightarrow \infty$, but the right-hand side does not: since $\mu(f_{n_k}) \rightarrow \mu(f)$, the first term in the right-hand side vanishes, and the second term does not depend on n_k and so is bounded. This is a contradiction.

The converse direction is where things get technical, though the idea is fairly approachable. Assume $\mu(\mathcal{F})$ is locally bounded. We want to show that \mathcal{F} is normal, which is equivalent to $\overline{\mathcal{F}}$ being compact. The Arzelà–Ascoli theorem tells us this is the case if and only if $\overline{\mathcal{F}}$ is closed, bounded, and equicontinuous.

The first two of these are not so bad: $\overline{\mathcal{F}}$ is definitely closed, being a closure, and moreover it is bounded; the point of working in \mathbb{C}_∞ is that it is compact—it's a (one-point) compactification of \mathbb{C} —in particular $d(z, w) \leq 2$ for all $z, w \in \mathbb{C}_\infty$ (remember, the metric in \mathbb{C}_∞ is defined as the Euclidean \mathbb{R}^3 distance between points on the unit sphere).

Therefore the only tricky bit is to show that $\overline{\mathcal{F}}$ is equicontinuous, which we want to show by proving that it is uniformly Lipschitz, which in turn we will acquire as a consequence of $\mu(\mathcal{F})$ being locally bounded. The bad news is that this last part is nontrivial.

We want to work on compact subsets of G , but for convenience we will restrict ourselves to closed disks $K = \overline{B(a, r)}$, of which we could patch together several to get any compact subset.

Since $\mu(\mathcal{F})$ is locally bounded, there exists $M > 0$ such that $\mu(f)(z) \leq M$ for all $z \in K$ and all $f \in \mathcal{F}$. Let $z, z' \in K$ and $f \in \mathcal{F}$.

There are three cases to consider. First, suppose neither z nor z' are poles of f . Let $\alpha > 0$ be arbitrary, and choose

$$w_0 = z, w_1, w_2, \dots, w_n = z'$$

in K satisfying

(i) for $w \in [w_{k-1}, w_k]$, w is not a pole of f ;

(ii) $\sum_{k=1}^n |w_k - w_{k-1}| \leq 2|z - z'|$;

(iii) $\left| \frac{1 + |f(w_{k-1})|^2}{(1 + |f(w_k)|^2)(1 + |f(w_{k-1})|^2)} - 1 \right| < \alpha$ for all $1 \leq k \leq n$; and

(iv) $\left| \frac{f(w_k) - f(w_{k-1})}{w_k - w_{k-1}} - f'(w_{k-1}) \right| < \alpha$ for all $1 \leq k \leq n$.

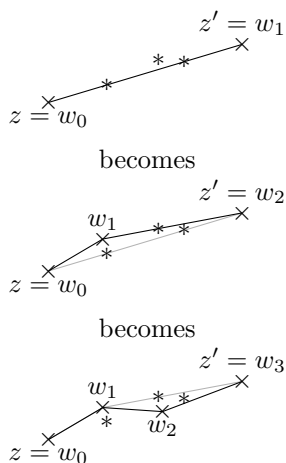

Figure 16.1.1: Creating a polygonal path from z to z' avoiding poles of f , poles signified by $*$.

That such a polygonal path can always be found requires a little bit of care. Certainly we can always find a path satisfying (i) and (ii)—start by connecting z and z' by a straight line segment. If $[z, z']$ does not pass through any poles of f , we are done. If it does, perturb a point on the line segment by a minuscule amount to avoid the pole, and repeat. A sketch of this process is shown in Figure 16.1.1 (though it is by no means the only approach).

Once a polygonal path P satisfying (i) and (ii) is found, note that conditions (iii) and (iv) are essentially convergence conditions on $f(w_k)$ and $f(w_{k-1})$ being close in the d -sense (for (iii)) and (iv) is about the limit quotient approaching the derivative. Since both of those *do* converge, we can find small enough balls along P that they hold—we can in fact cover P with such balls.

Now since P is compact, we can moreover select a finite subcover of those balls, and then specifically pick points w_0, w_1, \dots, w_n on P such that each line segment $[w_{k-1}, w_k]$ lies in one of those balls. The resulting collection $\{w_0, w_1, \dots, w_n\}$ satisfies all four conditions.

Lecture 17 Compactness in $M(G)$, continued

17.1 Compactness in the space of meromorphic functions, finalised

Proof, continued. The goal, as mentioned, is to establish that $d(f(z), f(z'))$ is well approximated by $\mu(f)(z)|z - z'|$, so that $\mu(f)$ being uniformly bounded on compact subsets gives us that f is uniformly Lipschitz.

With the polygonal as set up above, let $\beta_k = (1 + |f(w_{k-1})|^2)^{1/2}(1 + |f(w_k)|^2)^{1/2}$, and study the aforementioned distance. By the triangle inequality,

$$d(f(z), f(z')) \leq \sum_{k=1}^n d(f(w_{k-1}), f(w_k)) = \sum_{k=1}^n \frac{2|f(w_{k-1}) - f(w_k)|}{\beta_k}$$

by the definition of d (see page 57) since neither the polygonal path ever touches a pole in this case. By the triangle inequality again, adding and subtracting $f'(w_k)(w_k - w_{k-1})$,

$$\begin{aligned} d(f(z), f(z')) &\leq \sum_{k=1}^n \frac{2}{\beta_k} \left| \frac{f(w_{k-1}) - f(w_k)}{w_k - w_{k-1}} - f'(w_k) \right| |w_k - w_{k-1}| \\ &\quad + \sum_{k=1}^n \frac{2}{\beta_k} |f'(w_k)| |w_k - w_{k-1}|. \end{aligned}$$

Recall from (i),

$$\mu(f)(z) = \frac{2|f'(z)|}{1 + |f(z)|^2}$$

if z is not a pole of f , so $2|f'(w_k)| \leq M(1 + |f(w_k)|^2)$. Hence by this and (iv),

$$d(f(z), f(z')) < 2\alpha \sum_{k=1}^n \frac{|w_k - w_{k-1}|}{\beta_k} + M \sum_{k=1}^n \frac{1 + |f(w_k)|^2}{\beta_k} |w_k - w_{k-1}|.$$

Notice how by construction $\beta_k \geq 1$, and so $\frac{1}{\beta_k} \leq 1$, and by the triangle inequality

$$\left| \frac{1 + |f(w_k)|^2}{\beta_k} \right| \leq \left| \frac{1 + |f(w_k)|^2}{\beta_k} - 1 \right| + 1,$$

so

$$\begin{aligned} d(f(z), f(z')) &< 2\alpha \cdot 2|z - z'| + M \sum_{k=1}^n (\alpha|w_k - w_{k-1}| + 1 \cdot |w_k - w_{k-1}|) \\ &\leq (2\alpha + \alpha M + M) \cdot 2|z - z'|, \end{aligned}$$

by applying (iii) and (ii). Since $\alpha > 0$ is arbitrary, let $\alpha \rightarrow 0$, whence

$$d(f(z), f(z')) \leq 2M|z - z'|,$$

so f is Lipschitz if we avoid poles.

For the second case, suppose z' is a pole of f but z is not, and take $w \in K$ not a pole of f . Then

$$d(f(z), f(z')) = d(f(z), \infty) \leq d(f(z), f(w)) + d(f(w), \infty)$$

since $f(z') = \infty$. From the first case $d(f(z), f(w)) < 2M|z - w|$, so

$$d(f(z), f(z')) < 2M|z - w| + d(f(w), \infty).$$

Now let $w \rightarrow z'$, in which case the first term goes to $2M|z - z'|$, and the second term goes to 0 since f is continuous. Hence again

$$d(f(z), f(z')) \leq 2M|z - z'|.$$

Finally consider the case where both z and z' are poles of f . Then trivially $d(f(z), f(z')) = d(\infty, \infty) = 0$, which is of course bounded by $2M|z - z'|$.

So in any case, $d(f(z), f(z')) \leq 2M|z - z'|$, \mathcal{F} is uniformly Lipschitz, meaning \mathcal{F} is equicontinuous on K . This in turn implies \mathcal{F} is equicontinuous on all of G by the usual compactness argument of Proposition 13.1.1, and so $\overline{\mathcal{F}}$ is equicontinuous on G . \square

The main application of this is:

17.2 Riemann mapping theorem

Definition 17.2.1 (Conformal equivalence). A region G_1 is said to be **conformally equivalent** to another region G_2 if there exists an analytic $f: G_1 \rightarrow G_2$ such that f is one-to-one and onto (i.e., $f(G_1) = G_2$).

Remark 17.2.2. By Exercise 6.1, f being one-to-one and analytic implies $f'(z) \neq 0$ for all $z \in G$, which implies f is conformal, hence the term conformally equivalent.

By Exercise 10.1, f^{-1} is also analytic.

We have not proved, but it is also true that a conformal mapping must be analytic. Together these three remarks mean that there exist a number of equivalent definitions of conformal equivalence.

Theorem 17.2.3 (Riemann mapping theorem). *Let G be a simply connected region and $G \neq \mathbb{C}$. Let $a \in G$. Then there exists a unique analytic function $f: G \rightarrow \mathbb{C}$ satisfying*

- (i) $f(a) = 0$, $f'(a) \in \mathbb{R}$, and $f'(a) > 0$;
- (ii) f is one-to-one; and
- (iii) $f(G) = D := \{z \in \mathbb{C} \mid |z| < 1\}$.

Remark 17.2.4. Parts (ii) and (iii) mean that G is conformally equivalent to D .

Note that \mathbb{C} is not conformally equivalent to any bounded region. If it were, i.e., we had an analytic function $f: \mathbb{C} \rightarrow G$, G a bounded region, then being analytic in \mathbb{C} , f is entire, so by Liouville's theorem f must be constant, having a bounded image.

Lecture 18 The Riemann Mapping Theorem

18.1 Proving the Riemann mapping theorem

We will start by proving uniqueness, which is the easier part by a good margin:

Proof of the Riemann mapping theorem, (uniqueness). Let f and g be two analytic functions both satisfying the properties of the theorem. Then since $f: G \rightarrow D$ and $g: G \rightarrow D$, $f \circ g^{-1}: D \rightarrow D$.

Since $f(a) = g(a) = 0$, we have in turn that $f \circ g^{-1}(0) = f(a) = 0$. Hence $f \circ g^{-1}$ is one-to-one, onto, and analytic (so it is an automorphism of D). Then by the Schwarz–Pick theorem, there exists $c \in \mathbb{C}$ with $|c| = 1$ so that $f \circ g^{-1}(z) = cz$ for every $z \in D$. Hence $f(z) = cg(z)$, so $0 < f'(a) < cg'(a)$, where $g'(a)$, implying that $c \in \mathbb{R}$ and $c > 0$. The only positive real number with $|c| = 1$ is $c = 1$, so $f = g$. \square

For the existence part of the proof it suffices to prove the following lemma:

Lemma 18.1.1. *Let G be a region and $G \neq \mathbb{C}$. Suppose every non-vanishing analytic function on G has an analytic square root. Let $a \in G$. Then there exists an analytic function $f: G \rightarrow \mathbb{C}$ such that*

- (i) $f(a) = 0$, $f'(a) \in \mathbb{R}$, and $f'(a) > 0$;
- (ii) f is one-to-one; and
- (iii) $f(G) = D$.

That this is sufficient is motivated by an old result of ours, namely Corollary 6.1.3, and is the only reason we need simple connectedness in the Riemann mapping theorem: An non-vanishing analytic function $f: G \rightarrow \mathbb{C}$ on a simply connected region G can be written as $f(z) = \exp(g(z))$ where $g(z)$ is analytic. Hence we can define an analytic square root of $f(z)$ as $\exp(\frac{1}{2}g(z))$.

All by way of saying, if G is simply connected, then the existence of an analytic square root in the lemma is automatic.

Proof of Lemma 18.1.1. Let

$$\mathcal{F} = \{ f \in H(G) \mid f \text{ is one-to-one, } f'(a) \in \mathbb{R}, f'(a) > 0, \text{ and } f(G) \subset D \}.$$

In other words, \mathcal{F} is the family of functions satisfying the conditions (i)–(iii) we want, with the exception that $f(G) \subset D$ instead of $f(G) = D$.

Assume for now, and we will prove momentarily, that

- (a) $\mathcal{F} \neq \emptyset$, and
- (b) $\overline{\mathcal{F}} = \mathcal{F} \cup \{0\}$.

Since $f(G) \subset D$ for every $f \in \mathcal{F}$, \mathcal{F} is locally bounded. Montel's theorem implies \mathcal{F} is normal, and hence $\overline{\mathcal{F}}$ is compact.

Consider the function $H(G) \rightarrow \mathbb{C}$ defined by $f \mapsto |f'(a)|$. This is continuous, meaning that, since $\overline{\mathcal{F}}$ is nonempty (since \mathcal{F} is nonempty) and compact, there exists a maximum, i.e., there exists some $f \in \overline{\mathcal{F}}$ such that $|f'(a)| \geq |g'(a)|$ for all $g \in \overline{\mathcal{F}}$. So in particular, $f'(a) \geq g'(a)$ for all $g \in \mathcal{F}$, since restricted to \mathcal{F} these quantities are positive.

Hence $f \in \mathcal{F}$ since, per above, $\overline{\mathcal{F}} = \mathcal{F} \cup \{0\}$.

If we can then show that, for this particular choice of f , $f(G) = D$, we are done. To this end, suppose not. That is, suppose there exists some $w \in D$ such that $w \notin f(G)$. Then

$$\frac{f(z) - w}{1 - \overline{w}f(z)}$$

is analytic on G (since $|w| < 1$ and $|f(z)| < 1$ means the denominator never vanishes) and it never vanishes on G (since by choice $f(z) \neq w$ for $z \in G$).

By hypothesis this function has an analytic square root, in other words there exists an analytic function $h: G \rightarrow \mathbb{C}$ such that

$$(18.1.1) \quad h(z)^2 = \frac{f(z) - w}{1 - \bar{w}f(z)}.$$

Note that $T(\xi) = \frac{\xi - w}{1 - \bar{w}\xi}$ is a Möbius transformation mapping D to D (specifically what we called $\varphi_w(\xi)$ when discussing automorphisms of the unit disk, see page 40) and $f(G) \subset D$, meaning that $h(G) \subset D$.

Define a new function $g: G \rightarrow \mathbb{C}$ by

$$g(z) = \frac{|h'(a)|}{h'(a)} \frac{h(z) - h(a)}{1 - \overline{h(a)}h(z)}.$$

We want to show that $g \in \mathcal{F}$ and that $g'(a) > f'(a)$, which would contradict the choice of f as having maximal derivative.

First, g is one-to-one simply because f is one-to-one, so h is one-to-one since it is a composition of a Möbius transformation (which is one-to-one) and f , and f in turn is a composition of a Möbius transformation and h .

That $g(a) = 0$ is clear—just plug in $z = a$. Finally, for the derivative, we compute

$$\begin{aligned} g'(a) &= \frac{|h'(a)|}{h'(a)} \frac{h'(z)(1 - \overline{h(a)}h(z)) - (h(z) - h(a))(-\overline{h(a)})}{(1 - \overline{h(a)}h(z))^2} \Big|_{z=a} \\ &= \frac{|h'(a)|}{h'(a)} \frac{h'(a)(1 - |h(a)|^2)}{(1 - |h(a)|^2)^2} = \frac{|h'(a)|}{1 - |h(a)|^2}. \end{aligned}$$

By Equation (18.1.1),

$$|h(a)|^2 = \frac{|f(a) - w|}{|1 - \bar{w}f(a)|} = |-w| = |w|$$

since $f(a) = 0$, and hence differentiating $2h(a)h'(a) = f'(a)(1 - |w|^2)$, so

$$|h'(a)| = \left| \frac{f'(a)(1 - |w|^2)}{2h(a)} \right| = \frac{f'(a)(1 - |w|^2)}{2|h(a)|}$$

since $f'(a) > 0$ and $1 - |w|^2 > 0$ because $|w| < 1$, and so

$$|h'(a)| = \frac{f'(a)(1 - |w|^2)}{2\sqrt{|w|}}.$$

Putting this back into $g'(a)$, this means

$$g'(a) = \frac{f'(a)(1 - |w|^2)}{2\sqrt{|w|}} \frac{1}{1 - |w|} = f'(a) \frac{1 + |w|}{2\sqrt{|w|}}.$$

Rewriting

$$\frac{1 + |w|}{2\sqrt{|w|}} = \frac{1}{2\sqrt{|w|}} + \frac{\sqrt{|w|}}{2},$$

we can view this as the arithmetic mean of $\frac{1}{\sqrt{|w|}}$ and $\sqrt{|w|}$, and so by the inequality of arithmetic and geometric means, we have the bound

$$\frac{1 + |w|}{2\sqrt{|w|}} \geq \sqrt{\frac{1}{\sqrt{|w|}} \sqrt{|w|}} = 1.$$

In particular, equality holds only if the terms we are averaging are equal, that is $\frac{1}{\sqrt{|w|}} = \sqrt{|w|}$, meaning that $|w| = 1$. But by assumption $w \in D$, so $|w| < 1$, whence $|w| \neq 1$, giving us strict inequality. Hence $g'(a) > f'(a)$ as desired, contradicting the maximality of $f'(a)$ in \mathcal{F} , which means our assumption of $D \setminus f(G) \neq \emptyset$ is false, so $f(G) = D$.

Looking back, it remains to show (a) and (b) in order to finish our proof.

First, for (a), let us show $\mathcal{F} \neq \emptyset$. Since $G \neq \mathbb{C}$, there exists some $b \in \mathbb{C} \setminus G$, and so the function $z - b$ is analytic and non-vanishing in G . Hence by hypothesis there exists an analytic square root $g: G \rightarrow \mathbb{C}$ such that $g(z)^2 = z - b$.

Since $z - b$ is one-to-one, so is g , and hence by Exercise 6.1 $g'(z) \neq 0$ for all $z \in G$. By the Open mapping theorem there exists some $r > 0$ such that $g(G) \supset B(g(a), r)$.

Now, in a bit of a leap, note how it is true that $g(G) \cap B(-g(a), r) = \emptyset$. To see this, suppose by way of contradiction that this is not the case. That is, suppose there exists some $z \in G$ such that $r > |g(z) + g(a)| = |-g(z) - g(a)|$. This implies $-g(z) \in B(g(a), r)$, and so by since $g(G) \supset B(g(a), r)$, there must exist some $w \in G$ so that $g(w) = -g(z)$. But then $g(w)^2 = (-g(z))^2$, so $w - b = z - b$, from which we gather that $w = z$. Then $g(w) = -g(w)$, so $w - b = -(w - b)$, so $w - b = 0$, whence $b = w \in G$, which is a contradiction— b was chosen specifically not to be in G .

Now take a Möbius transformation T such that $T(\mathbb{C} \setminus \overline{B(-g(a), r)}) = D$. This can be done since we can pick a Möbius transformation mapping the circle on the boundary of $B(-g(a), r)$ to the unit circle, and it maps connected components to connected components, so we can pick, in particular, the one that maps $g(a)$ to zero, i.e., $T(g(a)) = 0$.

Let $g_1 = T \circ g: G \rightarrow D$. Then g_1 is analytic, $g_1(a) = 0$, and since g and T are both one-to-one, so is g_1 , and therefore in particular $g_1'(a) \neq 0$.

Choose a complex number c , $|c| < 1$ so that $cg_1'(a) \in \mathbb{R}$ and $cg_1'(a) > 0$, and define a new function $g_2(z) = cg_1(z)$. Then $g_2'(a) > 0$, it is one-to-one since g_1 is, and $g_2(a) = 0$ by construction. Moreover $g_2(G) \subset D$, so $g_2 \in \mathcal{F}$, so \mathcal{F} is nonempty.

This leaves (b), namely showing $\overline{\mathcal{F}} = \mathcal{F} \cup \{0\}$. So let $\{f_n\} \subset \mathcal{F}$ and suppose $f_n \rightarrow f$ in $H(G)$ (since $H(G)$ is complete). Since $f_n(a) = 0$, $f(a) = 0$, and since $f_n'(a) > 0$, we know $f_n'(a) \rightarrow f'(a) \geq 0$.

Let $z_1 \in G$ be arbitrary and set $\xi = f(z_1)$ and $\xi_n = f_n(z_1)$. For $z_2 \neq z_1 \in G$, let $K = \overline{B(z_2, r)} \subset G$ such that $z_1 \notin K$. Then $f_n(z) - \xi_n$ never vanishes on K since f_n is one-to-one, and $f_n(z) - \xi_n \rightarrow f(z) - \xi$.

By Corollary 14.1.4 of Hurwitz's theorem, either $f(z) - \xi = 0$ for all $z \in K$, or $f(z) - \xi \neq 0$ for all $z \in K$. In the first case, $f(z) = \xi$ for all $z \in K$, so $f(z) = \xi$ for all $z \in G$. But $f(a) = 0$, so $\xi = 0$, so $f = 0$.

In the second case, $f(z) \neq \xi$ for all $z \in K$, so $f(z_2) \neq f(z_1)$, meaning that f is one-to-one since $z_1 \neq z_2$ are arbitrary. Hence $f'(z) \neq 0$ for all $z \in G$, which together with $f'(a) \geq 0$ means $f'(a) > 0$. Hence $f \in \mathcal{F}$.

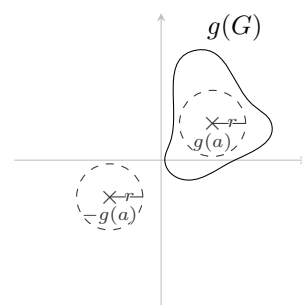

Figure 18.1.1: The image of g contains a ball by the Open mapping theorem. The reflected ball does not meet the image.

Therefore, as claimed, $\overline{\mathcal{F}} = \mathcal{F} \cup \{0\}$, finishing our proof of Lemma 18.1.1 and hence the Riemann mapping theorem. \square

Exercise 18.1. Let $G = \{z \mid \operatorname{Re}(z) > 0\}$. Let f be an analytic function on G such that $\operatorname{Re}(f(z)) > 0$ for all z in G and $f(a) = a$ for some a in G . Show that $|f'(a)| \leq 1$. \blacksquare

18.2 Entire functions

A long time ago (namely on page 15) we asked several questions about how the behaviour of entire functions compares to the behaviour of polynomials. We are about ready to answer one of them, namely: Does there exist an entire function with a prescribed set of zeros?

The answer is that it depends. If the set is finite, set $a_1, a_2, \dots, a_n \in \mathbb{C}$, then of course there exists an entire function f such that $f(a_i) = 0$ for every $i = 1, 2, \dots, n$, and $f(z) \neq 0$ for $z \neq a_i$, namely the polynomial

$$f(z) = (z - a_1)(z - a_2) \cdots (z - a_n).$$

A much more interesting situation, therefore is when the set is infinite, say $\{a_n\}_{n=1}^{\infty} \subset \mathbb{C}$. Does there exist an entire function f such that $f(a_i) = 0$ for $i = 1, 2, \dots$, and $f(z) \neq 0$ for $z \notin \{a_n\}$?

We need some restrictions on $\{a_n\}$. First, $\{a_n\}$ cannot be a bounded set, for otherwise, being a bounded sequence, it must contain some convergent subsequence, so the set has a limit point. In other words, if $\{a_n\}$ is bounded, f has a limit point of zeros, and so (all the way back from Theorem 4.1.9), f must be identically zero.

Second, $\{a_n\}$ cannot have a point repeated infinitely many times. If it does, then f would have a zero of infinite order, meaning that *all* its derivatives at that point are zero. This makes the power series around that point identically zero, so f is identically zero on an open neighbourhood of a point, so f is identically zero (or, alternatively, the aforementioned zero power series must have infinite radius of convergence since f is entire). That is to say, the order of any zero of a nonzero analytic function must be finite.

An easy way to satisfy both of these conditions is to require

$$\lim_{n \rightarrow \infty} |a_n| = \infty.$$

With this assumption, as it happens, the answer is the affirmative: there does exist some entire function f with $f(a_i) = 0$ for every $i = 1, 2, \dots$, and $f(z) \neq 0$ for $z \notin \{a_n\}$ —this is the Weierstrass factorisation theorem.

Of course the naïve attempt is

$$f(z) = \prod_{n=1}^{\infty} (z - a_n),$$

mimicking our approach in the polynomial case. The issue, and what we will spend the near discussing, is the question of convergence, and unfortunately $f(z)$ thus defined does not converge.

Lecture 19 Infinite Products

19.1 Review of infinite products

As hinted at toward the end of last lecture, we will soon have to deal with the matter of convergence of infinite products. To this end we need to settle what that means.

Definition 19.1.1 (Infinite product). Let $\{z_n\} \subset \mathbb{C}$. If

$$z = \lim_{k \rightarrow \infty} \prod_{n=1}^k z_n$$

exists, then we denote

$$z = \prod_{n=1}^{\infty} z_n$$

as the *infinite product* of z_n .

Remark 19.1.2. Of course there are cases in which this is trivially zero. First, if $z_n = 0$ for some n , then $z = 0$.

Similarly, if $z_n = a$ for all n is constant, then if $|a| < 1$,

$$\prod_{n=1}^{\infty} z_n = 0.$$

Suppose, in view of this, $\{z_n\} \subset \mathbb{C} \setminus \{0\}$ and

$$\prod_{n=1}^{\infty} z_n = z \neq 0.$$

Then setting

$$P_k = \prod_{n=1}^k z_n,$$

we get $z_k = \frac{P_k}{P_{k-1}}$. Thus $z_k \rightarrow \frac{z}{z} = 1$ as $k \rightarrow \infty$, so for n large enough, $z_n \neq 0$ (being close to 1), so we can define its logarithm

$$\log z_n = \log|z_n| + i \arg z_n,$$

taking the branch $-\pi < \arg z_n < \pi$.

Proposition 19.1.3. Let $\{z_n\} \subset \mathbb{C}$ such that $\operatorname{Re}(z_n) > 0$ for all n .⁶ Then

$$z = \prod_{n=1}^{\infty} z_n \neq 0$$

converges if and only if

$$\sum_{n=1}^{\infty} \log z_n,$$

taking the branch $-\pi < \arg z_n < \pi$, converges.

Date: October 22nd, 2019.

⁶Note how this is a minor assumption: just consider the tail, in general, and it must be true if the product converges.

Proof. The meat of the proposition is the forwards direction. Write $z = re^{i\theta}$, taking $-\pi < \theta \leq \pi$. Let

$$P_k = \prod_{n=1}^k z_n.$$

Since $P_k \rightarrow z$ as $k \rightarrow \infty$, for k large enough $\log_\theta P_k = \log|P_k| + i\theta_k$, where by \log_θ we mean the branch cut is $\theta - \pi < \theta_k < \theta + \pi$, i.e., the branch opposite z .

Let

$$S_k = \sum_{n=1}^k \log z_n$$

with the branch cut $-\pi < \arg z_n < \pi$. Then

$$\exp(S_k) = \prod_{n=1}^k z_n = P_k.$$

Taking logarithms, $S_k = \log_\theta P_k + 2\pi im_k$. Since $P_k \rightarrow z$ as $k \rightarrow \infty$,

$$\begin{aligned} S_k - S_{k-1} &= \log_\theta P_k - \log_\theta P_{k-1} + 2\pi i(m_k - m_{k-1}) \\ &= \log|z_k| + i(\theta_k - \theta_{k-1}) + 2\pi i(m_k - m_{k-1}). \end{aligned}$$

On the one hand, $S_k - S_{k-1} = \log z_k \rightarrow \log 1 = 0$ as $k \rightarrow \infty$ since $z \rightarrow 1$.

On the other hand, $\log|z_k| \rightarrow \log 1 = 0$, and $\theta_k - \theta_{k-1} \rightarrow 0$ since $P_k \rightarrow z$. Hence $m_k - m_{k-1} \rightarrow 0$ as $k \rightarrow \infty$, but both m_k and m_{k-1} are integers, so $m_k \rightarrow m$ for some integer m .

Thus, as $k \rightarrow \infty$, $S_k \rightarrow \log_\theta z + 2\pi im$, i.e.,

$$\sum_{n=1}^{\infty} \log z_n$$

converges.

Note how all of this is just to make sure the angle m_k converges, making sure it doesn't vary by multiples of $2\pi i$ as k changes.

The reverse direction is trivial: let

$$S_k = \sum_{n=1}^{\infty} \log z_n.$$

Assume $S_k \rightarrow s$ as $k \rightarrow \infty$. Then

$$\exp(S_k) = \prod_{n=1}^{\infty} z_n \rightarrow \exp(s) \neq 0. \quad \square$$

Remark 19.1.4. Since we need the factors to eventually be close to 1, it is sometimes more convenient to consider

$$\prod_{n=1}^{\infty} (1 + z_n).$$

The proposition then says that for $\operatorname{Re}(z_n) > -1$,

$$\prod_{n=1}^{\infty} (1 + z_n) \neq 0$$

if and only if

$$\sum_{n=1}^{\infty} \log(1 + z_n)$$

converges.

Notice two things. First, this means $z_n \rightarrow 0$ as $n \rightarrow \infty$, and second, $\log(1 + z) \approx z$ for z near zero. Hence:

Exercise 19.1. Let $\operatorname{Re}(z_n) > -1$. Then

$$\sum_{n=1}^{\infty} \log(1 + z_n)$$

converges absolutely if and only if

$$\sum_{n=1}^{\infty} z_n$$

converges absolutely. ■

This raises the question of how to correctly define absolute convergence for infinite products.

The first naïve attempt is to say that

$$\prod_{n=1}^{\infty} z_n$$

converges absolutely if

$$\prod_{n=1}^{\infty} |z_n| < \infty.$$

However this is not a terribly useful definition, because the latter product converging does not imply the former does. For instance, let $z_n = (-1)^n$. Then

$$\prod_{n=1}^{\infty} |(-1)^n| = 1,$$

but

$$\prod_{n=1}^{\infty} (-1)^n$$

does not converge—it oscillates between -1 and 1 .

A better choice, inspired by the above proposition, is:

Definition 19.1.5 (Absolute convergence). Let $\{z_n\} \subset \mathbb{C}$ with $\operatorname{Re}(z_n) > 0$ for all n . We say

$$\prod_{n=1}^{\infty} z_n$$

converges absolutely if

$$\sum_{n=1}^{\infty} \log z_n$$

converges absolutely.

With this definition, fortunately, absolute convergence does imply ordinary convergence.

Combining this with the observations from Exercise 19.1, we get

Corollary 19.1.6. *Let $\{z_n\} \subset \mathbb{C}$ with $\operatorname{Re}(z_n) > 0$ for all n . Then*

$$\prod_{n=1}^{\infty} z_n$$

converges absolutely if and only if

$$\sum_{n=1}^{\infty} (1 - z_n)$$

converges absolutely.

Since our method for translating information from infinite series to infinite products is the exponential function, we naturally ask the following question: Let X be a metric space, and let $f_n: X \rightarrow \mathbb{C}$, $n = 1, 2, \dots$. Suppose $f_n \rightarrow f$ uniformly on X . Do we have

$$\exp(f_n) \rightarrow \exp(f)$$

uniformly on X ? The answer, in general, is no—as it happens, though f_n and f are ‘close’, the exponential can amplify these small differences a lot.

Counterexample 19.1.7. Let $f_n(x) = \frac{x}{n} + \frac{1}{x}$ for $x \in (0, 1)$. As $n \rightarrow \infty$, $f_n(x) \rightarrow \frac{1}{x}$ uniformly on $(0, 1)$.

However $\exp(f_n)$ does not converge uniformly to $\exp(f)$:

$$\exp(f_n(x)) - \exp(f(x)) = \exp\left(\frac{1}{x}\right) \left(\exp\left(\frac{x}{n}\right) - 1 \right).$$

Take $x = \frac{1}{n}$. Then

$$\exp(f_n(x)) - \exp(f(x)) = \exp(n) \left(\exp\left(\frac{1}{n^2}\right) - 1 \right) \approx \exp(n) \frac{1}{n^2} \rightarrow \infty$$

as $n \rightarrow \infty$. (To see this, write $\exp(\frac{1}{n^2})$ as its power series.) Hence this does not converge uniformly (though it does converge pointwise). \blacktriangle

In looking for a sufficient condition to alleviate this issue, consider $\exp(f_n) \rightarrow \exp(f)$ pointwise. This means, roughly,

$$\left| \frac{\exp(f_n)}{\exp(f)} - 1 \right| < \varepsilon,$$

and so multiplying by $\exp(f)$,

$$|\exp(f_n) - \exp(f)| < \varepsilon \exp(f).$$

Hence if $\exp(f)$ is uniformly bounded, then $\exp(f_n) \rightarrow \exp(f)$ does converge uniformly. Formally:

Lemma 19.1.8. *Let X be a metric space, and let $f, f_n: X \rightarrow \mathbb{C}$, $n = 1, 2, \dots$. Suppose $f_n \rightarrow f$ uniformly on X . Suppose there exists some $a \in \mathbb{R}$ such that $\operatorname{Re}(f(x)) < a$ for all $x \in X$ (so $|\exp(f(x))| = \exp(\operatorname{Re}(f(x)))$ is uniformly bounded). Then $\exp(f_n) \rightarrow \exp(f)$ uniformly on X .*

Proof. Since $e^z \rightarrow 1$ as $z \rightarrow 0$, for any $\varepsilon > 0$ there exists $\delta > 0$ such that if $|z| < \delta$, then $|e^z - 1| < \varepsilon e^{-a}$.

Since $f_n \rightarrow f$ uniformly on X , there exists $N \in \mathbb{N}$ such that for $n > N$, $|f_n(x) - f(x)| < \delta$ for all $x \in X$. Hence for $n > N$, $|\exp(f_n(x)) - \exp(f(x))| < \varepsilon e^{-a}$, so

$$\left| \frac{\exp(f_n(x))}{\exp(f(x))} - 1 \right| < \varepsilon e^{-a}.$$

Multiplying both sides by $\exp(f(x))$, this becomes

$$|\exp(f_n(x)) - \exp(f(x))| < \varepsilon e^{-a} |\exp(f(x))| \leq \varepsilon e^{-a} e^a = \varepsilon$$

for all $x \in X$ since $|\exp(f(x))| = \exp(\operatorname{Re}(f(x))) \leq e^a$ for all $x \in X$. \square

Lemma 19.1.9. *Let X be a compact metric space. Let $g_n: X \rightarrow \mathbb{C}$, $n = 1, 2, \dots$, be continuous. Suppose*

$$\sum_{n=1}^{\infty} g_n(x)$$

converges absolutely and uniformly on X . Then

$$f(x) := \prod_{n=1}^{\infty} (1 + g_n(x))$$

converges absolutely and uniformly on X .

Moreover, there exists an $N \in \mathbb{N}$ such that $f(x) = 0$ if and only if $f_n(x) = -1$ for some n with $1 \leq n \leq N$.

Proof. The series

$$\sum_{n=1}^{\infty} g_n(x)$$

converging uniformly means there exists some $N \in \mathbb{N}$ such that for $n > N$, $|g_n(x)| < \frac{1}{2}$ for all $x \in X$. Hence $\operatorname{Re}(1 + g_n(x)) > 0$ for all $n > N$, $x \in X$. Thus, for $n > N$, $\log(1 + g_n(x))$ is defined.

Looking at the power series of $\log(1 + z)$, we see that $|\log(1 + z)| \leq \frac{3}{2}|z|$ for all $|z| \leq \frac{1}{2}$, so moreover $|\log(1 + g_n(x))| \leq \frac{3}{2}|g_n(x)|$ for all $n > N$ and $x \in X$.

Hence

$$\sum_{n=N+1}^{\infty} \log(1 + g_n(x)),$$

being bounded by

$$\frac{3}{2} \sum_{n=N+1}^{\infty} |g_n(x)|,$$

converges absolutely and uniformly on X . Therefore

$$h(x) := \sum_{n=N+1}^{\infty} \log(1 + g_n(x)),$$

being the limit of a uniformly convergent sequence of continuous functions, is continuous. Since X is compact, $h(x)$ is bounded on X , so $\operatorname{Re}(h(x)) < a$ for some $a \in \mathbb{R}$ for all $x \in X$. By Lemma 19.1.8, taking exponentials,

$$\exp(h(x)) = \prod_{n=N+1}^{\infty} (1 + g_n(x))$$

converges uniformly on X .

Thus

$$f(x) = (1 + g_1(x))(1 + g_2(x)) \dots (1 + g_n(x)) \exp(h(x))$$

converges absolutely and uniformly on X since a finite number of factors doesn't affect convergence.

Moreover, $\exp(h(x)) \neq 0$ for all $x \in X$ because of the exponential, hence if $f(x) = 0$, then $f_n(x) = -1$ for some $1 \leq n \leq N$ since the zero must come from the finite part. \square

Translating this back to analytic functions on \mathbb{C} , this becomes

Theorem 19.1.10. *Let $G \subset \mathbb{C}$ be a region. Let $\{f_n\} \subset H(G)$ such that no f_n is identically zero. Suppose*

$$\sum_{n=1}^{\infty} (f_n(z) - 1)$$

converges absolutely and uniformly on compact subsets of G . Then

$$f(z) = \prod_{n=1}^{\infty} f_n(z)$$

converges and $f(z) \in H(G)$.

Moreover, if $z = a$ is a zero of f , then $z = a$ is a zero of a finite number of $f_n(z)$, and the multiplicity of the zero of f is the sum of the multiplicities of the zeros of f_n .

Lecture 20 Weierstrass Factorisation Theorem

20.1 Elementary factors

Definition 20.1.1 (Elementary factors). An *elementary factor* is one of the following functions $E_n(z)$, $n = 0, 1, 2, \dots$,

$$E_0(z) = 1 - z,$$

$$E_n(z) = (1 - z) \exp\left(z + \frac{z^2}{2} + \dots + \frac{z^n}{n}\right), \quad \text{for } n \geq 1.$$

Remark 20.1.2. These functions $E_n(z)$ have simple zeros at $z = 1$, so $E_n(\frac{z}{a})$ has a simple zero at $z = a$, and no other zeros.

Our goal is to construct an entire function with a prescribed set of zeros $\{a_n\}$, so naturally we will want to consider something like

$$\prod_{i=1}^{\infty} E_{n_i}\left(\frac{z}{a_i}\right).$$

By Corollary 19.1.6 from last lecture, such a quantity converges if and only if

$$\sum_{i=1}^{\infty} \left(1 - E_{n_i}\left(\frac{z}{a_i}\right)\right)$$

converges. Hence we want to estimate:

Lemma 20.1.3. For $|z| \leq 1$, $|1 - E_n(z)| \leq |z|^{n+1}$ for all $n \geq 0$.

Proof. For $n = 0$, $1 - E_0(z) = z$, so the result holds.

Let $n \geq 1$. Since $E_n(z)$ is entire, it has a power series expansion at $z = 0$, say

$$E_n(z) = 1 + \sum_{n=1}^{\infty} a_n z^n,$$

and so

$$E'_n(z) = \sum_{n=1}^{\infty} k a_k z^{k-1}.$$

On the other hand, from the definition of $E_n(z)$, the product rule gives us

$$E'_n(z) = -z^n \exp\left(z + \frac{z^2}{2} + \cdots + \frac{z^n}{n}\right),$$

and since

$$\exp\left(z + \frac{z^2}{2} + \cdots + \frac{z^n}{n}\right) = 1 + \left(z + \frac{z^2}{2} + \cdots + \frac{z^n}{n}\right) + \left(z + \frac{z^2}{2} + \cdots + \frac{z^n}{n}\right)^2 + \cdots,$$

the power series expansion of $E'_n(z)$ starts at z^n (i.e., $a_1 = a_2 = \cdots = a_n = 0$) and all the coefficients $a_k \leq 0$. Therefore $|a_k| = -a_k$, and so

$$0 = E_n(1) = 1 + \sum_{k=1}^{\infty} a_k,$$

implying that

$$\sum_{k=1}^{\infty} |a_k| = 1.$$

Hence for $|z| \leq 1$, combining the facts that $a_1 = a_2 = \cdots = a_n = 0$ and that

the sum of the magnitude of the coefficients is 1, we get

$$\begin{aligned}
 |1 - E_n(z)| &= \left| \sum_{k=1}^{\infty} a_k z^k \right| \leq \sum_{k=1}^{\infty} |a_k| |z|^k = \sum_{k=n+1}^{\infty} |a_k| |z|^k \\
 &= |z|^{n+1} \sum_{k=n+1}^{\infty} |a_k| |z|^{k-(n+1)} \\
 &\leq |z|^{n+1} \sum_{k=n+1}^{\infty} |a_k| = |z|^{n+1}. \quad \square
 \end{aligned}$$

Recalling the discussion on page 68 and having the above in mind, we get

Theorem 20.1.4. *Let $\{a_n\} \subset \mathbb{C}$ such that $\lim_{n \rightarrow \infty} |a_n| = \infty$, and $a_n \neq 0$ for all $n \geq 1$. Let $\{p_n\} \subset \mathbb{N} \cup \{0\}$ such that*

$$(20.1.1) \quad \sum_{n=1}^{\infty} \left(\frac{r}{|a_n|} \right)^{p_n+1} < \infty$$

for all $r > 0$. Then

$$f(z) = \prod_{n=1}^{\infty} E_{p_n} \left(\frac{z}{a_n} \right)$$

converges in $H(\mathbb{C})$, i.e., f is entire. Moreover f has zeros exactly at a_n , $n = 1, 2, \dots$, and if $z = a$ occurs in $\{a_n\}$ exactly m times, then f has a zero at $z = a$ of multiplicity m .

Remark 20.1.5. Note that the condition in (20.1.1) always holds for $p_n \geq n-1$. This is not hard to see. For any fixed $r > 0$, there exists an $N \in \mathbb{N}$ such that for $n > N$, $\frac{r}{|a_n|} < \frac{1}{2}$ (since $|a_n| \rightarrow \infty$), and therefore the tail

$$\sum_{n>N} \left(\frac{r}{|a_n|} \right)^{p_n+1} < \sum_{n>N} \left(\frac{1}{2} \right)^n < \infty,$$

converges, and the finite part does not affect the convergence.

Remark 20.1.6. Since $|a_n| \rightarrow \infty$ as $n \rightarrow \infty$, no point in $\{a_n\}$ can be repeated infinitely many times.

Proof. Suppose $\{p_n\} \subset \mathbb{N} \cup \{0\}$ satisfies (20.1.1). By Lemma 20.1.3, for $|z| \leq r$ and $n \geq N$ large enough such that $|a_n| \geq r$,

$$\left| 1 - E_{p_n} \left(\frac{z}{a_n} \right) \right| \leq \left| \frac{z}{a_n} \right|^{p_n+1} \leq \left| \frac{r}{a_n} \right|^{p_n+1},$$

then

$$\sum_{n \geq N} \left| 1 - E_{p_n} \left(\frac{z}{a_n} \right) \right| \leq \sum_{n \geq N} \left| \frac{r}{a_n} \right|^{p_n+1} < \infty$$

by assumption.

By Theorem 19.1.10, this means

$$f(z) = \prod_{n=1}^{\infty} E_{p_n} \left(\frac{z}{a_n} \right)$$

converges uniformly on $\overline{B(0, r)}$, with r arbitrary, so $f(z)$ converges uniformly on any compact subset of \mathbb{C} , whence $f \in H(\mathbb{C})$. Moreover the same Theorem 19.1.10 means $f(z)$ has zeros exactly at $z = a_n$, $n = 1, 2, \dots$ \square

Theorem 20.1.7 (Weierstrass factorisation theorem). *Let f be an entire function and let $\{a_n\}$ be the nonzero zeros of f (repeated according to multiplicity). Suppose $f(z)$ has a zero of order m at $z = 0$. Then there exists an entire function $g(z)$ and a sequence $\{p_n\} \subset \mathbb{N} \cup \{0\}$ such that*

$$f(z) = z^m \prod_{n=1}^{\infty} E_{p_n} \left(\frac{z}{a_n} \right) \exp(g(z)).$$

Remark 20.1.8. Per the above remark we can take $p_n = n$ (or $p_n = n - 1$). Then the theorem says

$$f(z) = z^m \prod_{n=1}^{\infty} E_n \left(\frac{z}{a_n} \right) \exp(g(z)).$$

Proof. By Theorem 20.1.4, the function

$$h(z) = z^m \prod_{n=1}^{\infty} E_{p_n} \left(\frac{z}{a_n} \right)$$

is entire and has exactly the same zeros as f , including multiplicities. This means that $\frac{f(z)}{h(z)}$ has only removable singularities, specifically at $z = 0$ (if $m \geq 1$), $z = a_1, a_2, \dots$. Hence there exists an entire function $k(z)$ such that $k(z) = \frac{f(z)}{h(z)}$ for all $z \neq 0, a_1, a_2, \dots$, and $k(z) \neq 0$ for all $z \in \mathbb{C}$. Since \mathbb{C} is simply connected, we can write $k(z) = \exp(g(z))$ for some $g(z) \in H(\mathbb{C})$ (this is Corollary 6.1.3). Consequently

$$f(z) = k(z)h(z) = \exp(g(z))z^m \prod_{n=1}^{\infty} E_{p_n} \left(\frac{z}{a_n} \right).$$

Originally this argument only tells us these are equal for $z \neq 0, a_1, a_2, \dots$, but two analytic functions being equal on a dense set must be equal everywhere (this is Corollary 4.1.10, for the record). \square

Exercise 20.1. Show that

$$\sin(\pi z) = \pi z \prod_{n=1}^{\infty} \left(1 - \frac{z^2}{n^2} \right)$$

for every $z \in \mathbb{C}$.

Notice how we specifically group the negative and positive zeros, writing

$$\prod_{n=1}^{\infty} \left(1 - \frac{z^2}{n^2} \right)$$

instead of

$$\prod_{n \in \mathbb{Z}} \left(1 - \frac{z}{n} \right).$$

There is good reason for this—think about the convergence of these two. \blacksquare

Note that this analysis is for functions analytic on the entire complex plane \mathbb{C} . A natural question to ask is whether we can have the same factorisation for $f \in H(G)$, where $G \neq \mathbb{C}$ is a region.

The answer to this question is yes, but the proof is more technical. The main reason for this is that our key estimate, namely Lemma 20.1.3, no longer holds in this case—it relies on $|\frac{z}{a_n}| \leq 1$ for n large enough, which we can no longer guarantee since we no longer know that $|a_n| \rightarrow \infty$ as $n \rightarrow \infty$.

All we know in this case is that for $f \in H(G)$ with zeros $\{a_n\}$, the set $|a_n|$ does not have a limit point in G .

The correct elementary factor to consider now is not $E_n(\frac{z}{a})$, for the reason just discussed, but instead $E_n(\frac{a-b}{z-b})$ for $b \in \mathbb{C} \setminus G$, which then has a simple zero at $z = a$, no other zeros in G , and is analytic in G —all properties we want.

Theorem 20.1.9. *Let $G \neq \mathbb{C}$ be a region and let $\{a_n\} \subset \mathbb{C}$ be a sequence of distinct points with no limit point in G . Let $\{m_n\} \subset \mathbb{N}$. Then there exists a function $f \in H(G)$ whose zeros are exactly $z = a_n$, $n = 1, 2, \dots$, with multiplicities m_n , respectively.*

Sketch of proof. Let $\{z_n\}$ be the sequence of a_n repeated with multiplicities m_n . Take a sequence $\{w_n\} \subset \mathbb{C} \setminus G$. Then $E_n(\frac{z_n - w_n}{z - w_n})$ is analytic in G and has a simple zero at $z = z_n$ and no other zeros. The goal then is to show that

$$f(z) = \prod_{n=1}^{\infty} E_n\left(\frac{z_n - w_n}{z - w_n}\right) \in H(G).$$

The technical part of showing this depends on the choice of w_n , namely choosing w_n such that $\lim_{n \rightarrow \infty} |z_n - w_n| = 0$. We can do this since $\{z_n\}$ has a limit point in $\mathbb{C} \setminus G$, so on ∂G . The idea, then, is to use this limit in order to bound

$$1 - E_n\left(\frac{z_n - w_n}{z - w_n}\right). \quad \square$$

Exercise 20.2. Let G be a region. Let $f, g: G \rightarrow \mathbb{C}$ be analytic functions. Show that there exist analytic functions f_1, g_1 , and h_1 on G such that $f(z) = h_1(z)f_1(z)$ and $g(z) = h_1(z)g_1(z)$ for all $z \in G$; and f_1 and g_1 have no common zeros. ■

Exercise 20.3. (a) Let $0 < |a| < 1$ and $|z| \leq r < 1$. Show that

$$\left| \frac{a + |a|z}{(1 - \bar{a}z)a} \right| \leq \frac{1+r}{1-r}.$$

(b) Let $\{a_n\} \subset \mathbb{C}$ with $0 < |a_n| < 1$ and $\sum_{n=1}^{\infty} (1 - |a_n|) < \infty$. Show that

$$B(z) = \prod_{n=1}^{\infty} \frac{|a_n|}{a_n} \left(\frac{a_n - z}{1 - \bar{a}_n z} \right)$$

converges in $H(B(0; 1))$ and that $|B(z)| \leq 1$. What are the zeros of $B(z)$?

(c) Find a sequence $\{a_n\}$ in $B(0; 1)$ such that $\sum_{n=1}^{\infty} (1 - |a_n|) < \infty$ and every number $e^{i\theta}$ is a limit point of $\{a_n\}$. ■

Remark 20.1.10. $B(z)$ is called a **Blaschke product**.

Corollary 20.1.11. *Let $f \in M(G)$. Then there exists function $g, h \in H(G)$ such that $f(z) = \frac{g(z)}{h(z)}$. In other words, viewed as algebraic structures, $M(G)$ is the quotient field of the integral domain $H(G)$ (this is an integral domain since it has no zero divisors, see Exercise 4.2).*

Proof. Let $\{a_n\}$ be the poles of f with orders m_n . Then by Theorem 20.1.9 there exists $h \in H(G)$ such that h has zeros exactly at $z = a_n$ with multiplicity m_n . Then $f(z)h(z)$ has only removable singularities. Hence there exists a function $g \in H(G)$ such that $f(z)h(z) = g(z)$ for every $z \notin \{a_n\}$, meaning that $f(z) = \frac{g(z)}{h(z)}$. \square

Lecture 21 Rank and Genus

21.1 Jensen's formula

Suppose $f(z)$ is an entire function. By Weierstrass factorisation theorem we can write

$$f(z) = z^m \exp(g(z)) \prod_{n=1}^{\infty} E_{p_n} \left(\frac{z}{a_n} \right).$$

The choice of p_n depends on how fast $|a_n| \rightarrow \infty$, because we need

$$\sum_{n=1}^{\infty} \left(\frac{r}{|a_n|} \right)^{p_n+1} < \infty.$$

So if $|a_n| \rightarrow \infty$ very fast, we can pick p_n quite small. That is to say, we want to control the growth rate of zeros of b , and we will show that the growth rate of zeros of f in $B(0, r)$, as $r \rightarrow \infty$, is related to the growth rate of

$$M(r) = \sup_{0 \leq \theta \leq 2\pi} |f(re^{i\theta})|.$$

The setup for this is not too complicated: let f be an analytic function in a neighbourhood of $\overline{B(0, r)}$, and suppose f does not vanish on $\overline{B(0, r)}$. Then we can define the logarithm of $f(z)$, and it is analytic on $B(0, r)$ (that is to say, there exists an analytic function $g(z)$ such that $f(z) = e^{g(z)}$).

The mean value property of analytic functions, this means

$$\log f(0) = \frac{1}{2\pi} \int_0^{2\pi} \log f(re^{i\theta}) d\theta.$$

Taking real parts, this becomes

$$\log |f(0)| = \frac{1}{2\pi} \int_0^{2\pi} \log |f(re^{i\theta})| d\theta,$$

if f is non-vanishing. The crucial insight here is that the left-hand side is fixed, and the integrand in the right-hand side is bounded by $M(r)$.

If f does have zeros, one's first thought is to divide them away and study a new, non-vanishing function. This is essentially the right idea, except dividing by $z - a_n$ directly does not give us any control of the size of those factors. To remedy this, we instead divide by carefully chosen Möbius transformations, the growth of which we have very good control over. This gives rise to:

Theorem 21.1.1 (Jensen's formula). *Let $f(z)$ be an analytic function on a neighbourhood of $\overline{B(0, r)}$. Let a_1, a_2, \dots, a_n be the zeros of f in $B(0, r)$, repeated according to multiplicity.⁷ Suppose $f(0) \neq 0$ and $f(z) \neq 0$ for all $|z| = r$. Then*

$$\log|f(0)| = -\sum_{k=1}^n \log\left(\frac{r}{|a_k|}\right) + \frac{1}{2\pi} \int_0^{2\pi} \log|f(re^{i\theta})| d\theta.$$

Proof. Recall how for $|\alpha| < 1$, the Möbius transformation

$$\varphi_\alpha(z) = \frac{z - \alpha}{1 - \bar{\alpha}z}$$

maps the unit disk D to D , and the unit circle ∂D to ∂D , and moreover $\varphi_\alpha(\alpha) = 0$. We want to use this on $B(0, r)$, so consider the diagram

$$\begin{array}{ccc} D & \xrightarrow{\varphi_\alpha} & D \\ \uparrow & \nearrow \Psi_a & \\ B(0, r) & & \end{array}$$

The natural way to move from $B(0, r)$ to D is to divide by r , so we define

$$\begin{aligned} \Psi_a(z) &:= \varphi_\alpha\left(\frac{z}{r}\right) = \frac{\frac{z}{r} - \alpha}{1 - \bar{\alpha}\frac{z}{r}} \\ &= \frac{z - \alpha r}{r - \bar{\alpha}z} = \frac{r(z - a)}{r^2 - \bar{a}z}, \end{aligned}$$

where we have relabelled $\alpha r = a$, so that $a \in B(0, r)$. Then $\Psi_a(z): B(0, r) \rightarrow D$, and it maps $\partial B(0, r)$ to ∂D . This is useful, because it means the magnitude of $\Psi_a(z)$ for $|z| = r$ is exactly 1.

Now define

$$F(z) = f(z) \prod_{k=1}^n \frac{r^2 - \bar{a}_k z}{r(z - a_k)}.$$

This has removable singularities at $z = a_k$, so just let $F(z)$ represent the analytic function on $B(0, r)$ we get by removing those singularities. Moreover $F(z) \neq 0$ in $\overline{B(0, r)}$, by construction, and therefore

$$\log|F(0)| = \frac{1}{2\pi} \int_0^{2\pi} \log|F(re^{i\theta})| d\theta.$$

⁷There are only finitely many zeros on $B(0, r)$, since otherwise they would have an infinite bounded sequence of zeros, so they would have a limit point, forcing f to be identically zero.

Replacing $F(z)$ per above, this yields

$$\log \left| f(0) \prod_{k=1}^n \left(\frac{r}{a_k} \right) \right| = \frac{1}{2\pi} \int_0^{2\pi} \log \left| f(re^{i\theta}) \prod_{k=1}^n \Psi_{a_k}(re^{i\theta}) \right| d\theta.$$

By the discussion above, $|\Psi_{a_k}(re^{i\theta})| = 1$; the product on the left-hand side becomes a sum when taken out of the logarithm, so

$$\log |f(0)| + \sum_{k=1}^n \log \left| \frac{r}{a_k} \right| = \frac{1}{2\pi} \int_0^{2\pi} \log |f(re^{i\theta})| d\theta.$$

Moving the sum to the other side completes the proof. \square

Exercise 21.1. In the hypothesis of Jensen's formula, do *not* suppose that $f(0) \neq 0$. Show that if f has a zero at $z = 0$ of multiplicity m , then

$$\log \left| \frac{f^{(m)}(0)}{m!} \right| + m \log r = - \sum_{k=1}^n \log \left(\frac{r}{|a_k|} \right) + \frac{1}{2\pi} \int_0^{2\pi} \log |f(re^{i\theta})| d\theta. \quad \blacksquare$$

Exercise 21.2. Let f be an entire function with $f(0) \neq 0$, and let

$$M(r) = \sup_{0 \leq \theta < 2\pi} |f(re^{i\theta})|.$$

Let $n(r)$ denote the number of zeros of f in $B(0, r)$, counted according to multiplicities. Suppose $f(0) = 1$ (else normalise, since $f(0) \neq 0$). Then

$$n(r) \log 2 \leq \log M(2r). \quad \blacksquare$$

21.2 The genus and rank of entire functions

Suppose f is entire. Again by Weierstrass factorisation theorem, we can write

$$f(z) = z^m \exp(g(z)) \prod_{n=1}^{\infty} E_{p_n} \left(\frac{z}{a_n} \right),$$

where $g(z)$ is an entire function.

Let us consider, in some sense, the simplest form this can take (without becoming trivial). The first nontrivial entire functions are polynomials, so we are interested in the case where $g(z)$ is a polynomial.

Similarly, the simplest form p_n can take is constant—so $p_n = p$ for all n . This is equivalent to

$$\sum_{n=1}^{\infty} \frac{1}{|a_n|^{p+1}} < \infty,$$

since in the original condition of Weierstrass factorisation theorem we have

$$\sum_{n=1}^{\infty} \left(\frac{r}{|a_n|} \right)^{p_n+1} < \infty,$$

but with $p_n = p$ a constant, r^{p+1} is a constant, so we can take that out of the sum.

Definition 21.2.1 (Rank). Let $f \in H(\mathbb{C})$ with nonzero zeros $\{a_1, a_2, \dots\}$, repeated according to multiplicities, and arranged such that $0 < |a_1| \leq |a_2| < \dots$. We say that f is of **finite rank** if there exists $p \in \mathbb{N} \cup \{0\}$ such that

$$\sum_{n=1}^{\infty} \frac{1}{|a_n|^{p+1}} < \infty.$$

If p is the smallest nonnegative integer such that this condition holds, then we say that f is of **rank** p .

Remark 21.2.2. (i) If f has only finitely many zeros, then the sum above always converges, and in particular converges for $p = 0$, so we say that f has rank 0.

(ii) We say that f is of **infinite rank** if it is not of finite rank. In other words, it is not of rank p for any p .

Remark 21.2.3. Suppose f is of finite rank p . Then

$$f(z) = z^m \exp(g(z)) \prod_{n=1}^{\infty} E_p\left(\frac{z}{a_n}\right).$$

Here m is the order of vanishing of f at $z = 0$, so m is unique. Similarly, the E_p terms are now uniquely determined, since we have chosen p as small as possible. Finally, $\exp(g(z))$ is also unique, meaning that the entire expression is unique except $g(z)$ may be replaced by $g(z) + 2\pi ik$ for $k \in \mathbb{Z}$.

Finally, we call

$$P(z) = \prod_{n=1}^{\infty} E_p\left(\frac{z}{a_n}\right)$$

the **standard form** of f .

Definition 21.2.4 (Genus). An entire function f has **finite genus** if f has finite rank and $g(z)$ is a polynomial, where $f(z) = z^m \exp(g(z))P(z)$ and $P(z)$ is the standard form of f .

Let p be the rank of f and q be the degree of $g(z)$. Then $\mu := \max\{p, q\}$ is called the **genus** of f .

Looking at this definition, this tells us that the genus of an entire function controls the factorisation. As it turns out, the genus also controls the growth of the function:

Theorem 21.2.5. *Let f be an entire function of finite genus μ . Then for any $\varepsilon > 0$,*

$$f(z) \ll_{\varepsilon, f} \exp(|z|^{\mu+1+\varepsilon}).$$

In particular, we have for some $M > 0$

$$\log|E_{\mu}(z)| \leq M|z|^{\mu+1}$$

as well as

$$\log|E_{\mu}(z)| \leq M|z|^{\mu}$$

for all $z \in \mathbb{C}$.

Remark 21.2.6. By the notation $f \ll g$ we mean that there exists some $c > 0$ such that $|f(z)| \leq c|g(z)|$ for all $z \in \mathbb{C}$, known as **Vinogradov notation**.

Note that, in the case of smooth f and g , this means we only need to consider $|z|$ large, since on bounded sets f and g are both bounded, so we can always find a c sufficiently large.

Remark 21.2.7. Which one of the bounds on $\log|E_\mu(z)|$ from the theorem one wants to use depends on $|z|$ —if $|z| < 1$ we would prefer a bigger power, since that results a smaller bound, and conversely for $|z| \geq 1$ we would want a smaller power.

Proof. Since $f(z)$ is of finite genus μ ,

$$f(z) = z^m \exp(g(z)) \prod_{n=1}^{\infty} E_\mu\left(\frac{z}{a_n}\right),$$

where $g(z)$ is a polynomial of degree at most μ . Taking logarithms, for $z \notin \{a_n\} \cup \{0\}$,

$$\log|f(z)| = m \log|z| + \operatorname{Re} g(z) + \sum_{n=1}^{\infty} \log\left|E_\mu\left(\frac{z}{a_n}\right)\right|.$$

We proceed to bound these three parts one at a time.

First, $\log|z| \leq M_1|z|^\varepsilon$ for any $\varepsilon > 0$, so definitely $\log|z| \leq M_1|z|^{\mu+1}$ for some $M_1 > 0$ and $|z|$ large.

Second, $|\operatorname{Re} g(z)| \leq |g(z)| \leq M_2|z|^\mu$ since $g(z)$ is a polynomial of degree at most μ , so in addition $|\operatorname{Re} g(z)| \leq M_2|z|^{\mu+1}$ for some $M_2 > 0$ and $|z|$ large.

Third, and most important, we study $\log|E_\mu(z)|$ as set out in the statement of the theorem. First, let $|z| < \frac{1}{2}$. Here since $|z|$ is small, we have the power series expansion

$$\log(1 - z) = -\left(z + \frac{z^2}{2} + \cdots + \frac{z^\mu}{\mu} + \cdots\right),$$

and so since

$$E_\mu(z) = (1 - z) \exp\left(z + \frac{z^2}{2} + \cdots + \frac{z^\mu}{\mu}\right)$$

we get

$$\begin{aligned} \log|E_\mu(z)| &= \log|1 - z| + \operatorname{Re}\left(z + \frac{z^2}{2} + \cdots + \frac{z^\mu}{\mu}\right) \\ &= -\operatorname{Re}\left(\frac{z^{\mu+1}}{\mu+1} + \frac{z^{\mu+2}}{\mu+2} + \cdots\right) \\ &= |z|^{\mu+1}(1 + |z| + |z|^2 + \cdots) \end{aligned}$$

where we have bounded the real part by the modulus, and noted that the denominators in the middle step are all bigger than 1. But now $|z| < \frac{1}{2}$, so this is bounded by a geometric sum, namely

$$\log|E_\mu(z)| \leq |z|^{\mu+1}\left(1 + \frac{1}{2} + \frac{1}{2^2} + \cdots\right) = 2|z|^{\mu+1}.$$

Since $|z| < \frac{1}{2} < 1$, making the power smaller enlarges the bound, so this also says $\log|E_\mu(z)| \leq 2|z|^\mu$.

On the other hand, for $|z| > 2$, we have

$$\log|E_\mu(z)| \leq \log|1 - z| + |z| + \frac{|z|^2}{2} + \cdots + \frac{|z|^\mu}{\mu} \leq C|z|^\mu$$

for some constant $C > 0$ since, $|z| > 2 > 1$ is large, the last term dominates. This time, $|z|$ being large, means enlarging the power enlarges the bound, so we also have $\log|E_\mu(z)| \leq C|z|^{\mu+1}$.

Finally, consider $\frac{1}{2} \leq |z| \leq 2$. Here, notice how $\log|E_\mu(z)|$ is a continuous function, except at $z = 1$, and there

$$\lim_{z \rightarrow 1} |E_\mu(z)| = -\infty,$$

meaning that $\log|E_\mu(z)|$ is bounded above, say $\log|E_\mu(z)| \leq D$ for some $D > 0$. Hence since $|z|$ lives in a bounded range, we have

$$\log|E_\mu(z)| \leq D_a|z|^a$$

for any power a , so in particular for the powers μ and $\mu + 1$.

Now

$$\sum_{n=1}^{\infty} \log \left| E_\mu \left(\frac{z}{a_n} \right) \right| \leq M_3 \sum_{n=1}^{\infty} \left(\frac{z}{|a_n|} \right)^{\mu+1} = M_3 |z|^{\mu+1} \sum_{n=1}^{\infty} \frac{1}{|a_n|^{\mu+1}},$$

where the final sum converges since f is of genus μ . Hence

$$\sum_{n=1}^{\infty} \log \left| E_\mu \left(\frac{z}{a_n} \right) \right| \leq M_4 |z|^{\mu+1}$$

for some $M_4 > 0$ and $|z|$ large.

Putting the three pieces together, this means

$$\log|f(z)| \leq K|z|^{\mu+1}$$

for some $K > 0$ and $|z|$ large, so

$$f(z) \ll \exp(|z|^{\mu+1+\varepsilon}),$$

where the $\varepsilon > 0$ comes from absorbing K into the exponential. \square

Lecture 22 Order

22.1 The order of entire functions

We showed last time that if f is an entire function of finite genus μ , then $f(z) \ll \exp(|z|^{\mu+1+\varepsilon})$ for any $\varepsilon > 0$.

Definition 22.1.1 (Order). An entire function f is of **finite order** if there exists $a \geq 0$ such that $f(z) \ll \exp(|z|^a)$.

If f is not of finite order, then we say f is of **infinite order**.

If f is of finite order, then $\lambda := \inf \{ a \mid f(z) \ll \exp(|z|^a) \}$ is called the **order** of f .

That is to say, if f is of order λ , then for any $\varepsilon > 0$ we have $f(z) \ll \exp(|z|^{\lambda+\varepsilon})$.

An equivalent way of saying this is that f being of order λ means that $\log|f(z)| \leq C_\varepsilon |z|^{\lambda+\varepsilon}$ for $|z|$ large. This is slightly delicate: when taking logarithms of $f(z) \ll \exp(|z|^{\lambda+\varepsilon})$ we cannot keep the \ll sign, for $f(z)$ could be very large in the negative direction, making $|f(z)|$ large, reversing the inequality.

Exercise 22.1. Look back at Exercise 21.2 and use it to prove that if f is of finite order λ , then $n(r) \ll_\varepsilon r^{\lambda+\varepsilon}$. ■

Exercise 22.2. Let f_1 and f_2 be entire functions of finite order λ_1 and λ_2 respectively. Let $f = f_1 + f_2$.

(a) Show that f has finite order $\lambda \leq \max\{\lambda_1, \lambda_2\}$.

(b) Show that $\lambda = \max\{\lambda_1, \lambda_2\}$ if $\lambda_1 \neq \lambda_2$.

(c) Give an example where $\lambda < \max\{\lambda_1, \lambda_2\}$ with $f \neq 0$. ■

Exercise 22.3. Let f_1 and f_2 be entire functions of finite order λ_1 and λ_2 respectively. Let $f = f_1 f_2$. Show that f has finite order $\lambda \leq \max\{\lambda_1, \lambda_2\}$. ■

By last lecture's discussion we then also have that finite genus implies finite order:

Corollary 22.1.2. *If f is entire of finite genus μ , then f is of finite order $\lambda \leq \mu + 1$.*

This means that the genus of an entire function, which by definition controls the factorisation, in fact also controls the growth of the function. The converse is also true.

22.2 Hadamard's factorisation theorem

Proposition 22.2.1. *Let f be an entire function of order λ which does not vanish in \mathbb{C} . Then $f(z) = \exp(g(z))$ where $g(z)$ is a polynomial of degree $\deg g \leq \lambda$. Thus f is of integral order $\deg g$.*

Proof. By the Weierstrass factorisation theorem, $f(z) = \exp(g(z))$ with $g(z)$ being entire (since f has no zeros, the other two parts of the Weierstrass factorisation disappear). Hence let

$$g(z) = \sum_{n=0}^{\infty} a_n z^n$$

be the power series expansion of g at $z = 0$. In order to show that $g(z)$ is a polynomial of degree at most λ we therefore need to show that $a_n = 0$ for all $n > \lambda$.

Since f is of order λ , for any $\varepsilon > 0$ there exists some $C_\varepsilon > 0$ such that $\operatorname{Re} g(z) = \log|f(z)| \leq C_\varepsilon |z|^{\lambda+\varepsilon}$ for $|z|$ large.

Remark 22.2.2. It is instructive, at this point, to note that this is not quite as easy as invoking Exercise 4.1, for the order only gives us a bound on $\log|f(z)| = \operatorname{Re} g(z) \leq C_\varepsilon |z|^{\lambda+\varepsilon}$, not $|g(z)|$.

Writing $\mathbb{C} \ni a_n = \alpha_n + i\beta_n$, where $\alpha_n, \beta_n \in \mathbb{R}$, and setting $z = Re^{2\pi i\theta}$, we have from the power series

$$\operatorname{Re} g(z) = \sum_{n=0}^{\infty} \alpha_n R^n \cos(2\pi n\theta) - \sum_{n=1}^{\infty} \beta_n R^n \sin(2\pi n\theta).$$

Note that the second sum starts at $n = 1$ since $\sin(0) = 0$.

Now we can use the orthogonality of sine and cosine to extract α_n and β_n . In particular, multiplying by $\cos(2\pi n\theta)$ and integrating from 0 to 1, we extract

$$\alpha_0 = \int_0^1 \operatorname{Re} g(Re^{2\pi i\theta}) d\theta$$

and

$$\alpha_n R^n = 2 \int_0^1 \operatorname{Re} g(Re^{2\pi i\theta}) \cos(2\pi n\theta) d\theta$$

for $n \geq 1$, and multiplying by $\sin(2\pi n\theta)$ and integrating from 0 to 1 produces

$$\beta_n R^n = 2 \int_0^1 \operatorname{Re} g(Re^{2\pi i\theta}) \sin(2\pi n\theta) d\theta$$

for $n \geq 1$. Since we want to show that $a_n = 0$ for $n > \lambda$, we need to show that $\alpha_n = \beta_n = 0$ for $n > \lambda$.

Since $|\cos(2\pi n\theta)| \leq 1$, we have

$$|\alpha_n R^n| \leq 2 \int_0^1 |\operatorname{Re} g(Re^{2\pi i\theta})| d\theta.$$

As per the remark, we couldn't use the bound from the order directly, since the inside of the absolute value might be large in the negative direction. The trick here is to add and subtract $\operatorname{Re} g(Re^{2\pi i\theta})$ in the integrand, resulting in

$$|\alpha_n R^n| \leq 2 \int_0^1 |\operatorname{Re} g(Re^{2\pi i\theta})| + \operatorname{Re} g(Re^{2\pi i\theta}) d\theta - 2 \int_0^1 \operatorname{Re} g(Re^{2\pi i\theta}) d\theta.$$

The second integral is nothing but $\alpha_0 = a_0$, and the first integrand is 0 if the real part is negative, and else just twice times itself, so

$$|\alpha_n R^n| \leq 2 \int_0^1 \max\{0, 2C_\varepsilon R^{\lambda+\varepsilon}\} d\theta - 2a_0 \leq 4C_\varepsilon R^{\lambda+\varepsilon} - 2a_0$$

since $\operatorname{Re} g(Re^{2\pi i\theta}) \leq C_\varepsilon R^{\lambda+\varepsilon}$ because f is of order λ .

Hence

$$|\alpha_n| \leq 4C_\varepsilon R^{\lambda-n+\varepsilon} - \frac{2a_0}{R^n},$$

which goes to 0 as $R \rightarrow \infty$ if $n > \lambda$. Hence $\alpha_n = 0$ for $n > \lambda$.

In precisely the same way, we see that $\beta_n = 0$ for $n > \lambda$, whence $a_n = \alpha_n + i\beta_n = 0$ for $n > \lambda$. Hence $g(z)$ is a polynomial of degree at most λ , meaning that $f(z) = \exp(g(z))$ is of integral order $\deg g$. \square

Theorem 22.2.3 (Hadamard's factorisation theorem). *Let f be an entire function of finite order λ . Then f has finite genus $\mu \leq \lambda$.*

In other words, the growth of an entire function also controls its factorisation.

Proof. Let p be the integer such that $p \leq \lambda < p + 1$, i.e., the integer part of λ . We claim that f has rank at most p .

To show this, let $\{a_n\}$ be the nonzero zeros of f , repeated according to multiplicity, and arranged such that $0 < |a_1| \leq |a_2| \leq \dots$. To show that f has rank at most p we need to show that

$$\sum_{n=1}^{\infty} \frac{1}{|a_n|^{p+1}} < \infty.$$

First, without loss of generality we may assume $f(0) = 1$, because if f has a zero of order m at $z = 0$, then $\frac{f(z)}{z^m}$ does not vanish at $z = 0$, and, for $z \neq 0$,

$$\log \left| \frac{f(z)}{z^m} \right| = \log |f(z)| - m \log |z| \leq C_\varepsilon |z|^{\lambda+\varepsilon},$$

since f is of order λ and $\log |z| \ll |z|^\varepsilon$. Note that this estimate also holds for z close to a_n , because then $\log |f(z)|$ is large negative, so the left-hand side is even smaller. Hence $\frac{f(z)}{z^m}$ has the same order as $f(z)$, and since it does not affect the rank since it touches only the first part of the Weierstrass factorisation.

Let $n(r)$ be the number of zeros of f in $B(0, r)$ counted according to multiplicity, and let

$$M(r) = \max_{|z|=r} |f(z)|.$$

Then, by Exercise 21.2,

$$n(r) \leq \frac{\log M(2r)}{\log 2}.$$

Since f has order λ , for any $\varepsilon > 0$, $\log M(2r) \ll r^{\lambda+\varepsilon}$, and consequently $n(r) \ll r^{\lambda+\varepsilon}$.

Now having arranged $0 < |a_1| \leq |a_2| \leq \dots \leq |a_k| \leq \dots$, we have for any $\delta > 0$ that $n(|a_k| + \delta) \geq k$. On the other hand, $n(|a_k| + \delta) \leq C(|a_k| + \delta)^{\lambda+\varepsilon}$ for some constant $C > 0$. Letting $\delta \rightarrow 0$, this implies $k \leq C|a_k|^{\lambda+\varepsilon}$.

Therefore

$$\frac{1}{|a_k|^{p+1}} \leq k^{-\frac{p+1}{\lambda+\varepsilon}},$$

and since $p \leq \lambda < p + 1$ we can choose ε small enough so that this power $\frac{p+1}{\lambda+\varepsilon}$ is bigger than 1. So for some $\varepsilon' > 0$,

$$\sum_{n=1}^{\infty} \frac{1}{|a_n|^{p+1}} \leq \sum_{n=1}^{\infty} n^{-(1+\varepsilon')}$$

which is convergent. Hence f has finite rank at most $p \leq \lambda$.

Lecture 23 Range of Analytic Functions

23.1 Proof of Hadamard's factorisation theorem

We start by finishing the proof started last time:

Proof of Hadamard's factorisation theorem, continued. By the Weierstrass factorisation theorem, we therefore have

$$f(z) = z^m \exp(g(z)) \prod_{n=1}^{\infty} E_p\left(\frac{z}{a_n}\right),$$

where for ease of discussion we will call the product at the end $P(z)$. We next wish to show that $g(z)$ is a polynomial of degree at most λ .

Consider the function $\frac{f(z)}{z^m P(z)}$. It is entire (or has only removable singularities, so remove them) and never vanishes in \mathbb{C} . Then, studying the orders of these terms,

$$\begin{aligned} \log \left| \frac{f(z)}{z^m P(z)} \right| &= \log |f(z)| - m \log |z| - \log |P(z)| \\ &\leq C_\varepsilon (|z|^{\lambda+\varepsilon} + |z|^\varepsilon + |z|^p) \\ &\leq K_\varepsilon |z|^{\lambda+\varepsilon} \end{aligned}$$

for $|z|$ large, since $p \leq \lambda$ and the terms in $P(z)$ are of the form

$$E_p(z) = (1 - z) \exp\left(z + \frac{z^2}{2} + \cdots + \frac{z^p}{p}\right),$$

at least for $p \geq 1$ (for $p = 0$ it is just $1 - z$).

In other words $\frac{f(z)}{z^m P(z)}$ is of finite order at most λ , and never vanishes, which by Proposition 22.2.1 means

$$\frac{f(z)}{z^m P(z)} = \exp(g(z))$$

where $g(z)$ is a polynomial of degree at most λ , meaning that $f(z)$ is of finite genus at most λ , finishing the proof. \square

As a small historic interlude, this theorem gives in particular a factorisation of the **Riemann zeta function** in terms of its zeros, a product representation first conjectured to exist by Riemann. It was in proving the existence of this product representation of the zeta function that Hadamard happened to prove the existence for all entire functions of finite order.

Aside from genus and order, there is a third related, and sometimes powerful, notion. To see how this is occasionally more useful, see in particular Exercise 23.2 (b).

Definition 23.1.1 (Exponent of convergence). Let $\{a_n\}$ be a sequence of non-zero complex numbers. Let

$$\rho = \inf \left\{ r \mid \sum_n \frac{1}{|a_n|^r} < \infty \right\},$$

called the *exponent of convergence* of $\{a_n\}$.

Exercise 23.1. (a) Let f be an entire function of rank p . Show that the exponent of convergence ρ of the non-zero zeros of f satisfies: $p \leq \rho \leq p + 1$.

(b) Let f be an entire function of order λ and let $\{a_n\}$ be the non-zero zeros of f repeated according to multiplicity. Let ρ be the exponent of convergence of $\{a_n\}$. Show that $\rho \leq \lambda$.

(c) Let $P(z) = \prod_{n=1}^{\infty} E_p\left(\frac{z}{a_n}\right)$ be a canonical product of rank p . Let ρ be the exponent of convergence of $\{a_n\}$. Show that the order of $P(z)$ is ρ . ■

Exercise 23.2. (a) Let f and g be entire functions of finite order λ . Suppose that $f(a_n) = g(a_n)$ for $\{a_n\}$ such that $\sum_n |a_n|^{-(\lambda+1)} = \infty$. Show that $f = g$.

(b) Replace the condition in (a) by $\sum_n |a_n|^{-(\lambda+\varepsilon)} = \infty$ for some $\varepsilon > 0$. Show that $f = g$.

(c) Find all entire functions f of finite order such that $f(\log n) = n$ for $n = 1, 2, \dots$. ■

23.2 The range of entire functions

Consider a polynomial $p(z)$, say of degree n , and let $c \in \mathbb{C}$. Then the polynomial $p(z) - c$ is also of degree n , and hence has precisely n roots (counting multiplicity), according to the Fundamental theorem of algebra. This means that the range of a polynomial is all of \mathbb{C} , and more precisely every point $c \in \mathbb{C}$ is attained exactly n times.

We wish to investigate the same question, that of the range, for entire functions in general.

Theorem 23.2.1 (Special case of Picard's theorem). *Let f be a non-constant entire function of finite order. Then $f(z)$ assumes each complex number with only one possible exception.*

Proof. Suppose there exist $\alpha, \beta \in \mathbb{C}$ be distinct points such that $f(z) \neq \alpha$ and $f(z) \neq \beta$ for all $z \in \mathbb{C}$. Then $f(z) - \alpha$ is entire and never vanishes in \mathbb{C} , so by Proposition 22.2.1 we can write $f(z) - \alpha = \exp(g(z))$ where $g(z)$ is a polynomial. That is to say, $f(z) = \exp(g(z)) + \alpha$.

Similarly, since $f(z) \neq \beta$ for all $z \in \mathbb{C}$ we have $\exp(g(z)) + \alpha \neq \beta$ for all $z \in \mathbb{C}$, meaning that $\exp(g(z)) \neq \beta - \alpha$.

Hence $g(z) \neq \log(\beta - \alpha)$ (note how $\beta - \alpha \neq 0$). But $g(z)$ is a polynomial, so its range is all of \mathbb{C} , making this a contradiction. □

This means that an entire function can miss only one point in \mathbb{C} .

The polynomial example brings up another natural question: if f is an entire function, how many times can $f(z)$ assume $a \in \mathbb{C}$?

As discussed, in the case of a degree n polynomial, the answer is precisely n times. We answer the question for entire functions analogously:

Theorem 23.2.2. *Let f be an entire function of finite order λ , where λ is not an integer. Then f has infinitely many zeros.*

Note that the order not being integral implies f is non-constant, since (nonzero) constants are of order 0.

Proof. Suppose f has only finitely many zeros, say $\{a_1, a_2, \dots, a_n\}$, repeated according to multiplicity. Then we can write

$$f(z) = (z - a_1)(z - a_2) \cdots (z - a_n) \exp(g(z)),$$

with g entire. Consider

$$\log \left| \frac{f(z)}{(z - a_1) \cdots (z - a_n)} \right| = \log |f(z)| - \log |z - a_1| - \cdots - \log |z - a_n| \leq C_\varepsilon |z|^{\lambda + \varepsilon}$$

for $|z|$ large. Hence $\frac{f(z)}{(z - a_1) \cdots (z - a_n)}$ has order at most λ , so $g(z)$ is a polynomial of degree λ by Proposition 22.2.1. Hence the order of f is the degree of g , which, being a polynomial, is an integer. This is a contradiction. \square

It is worth noting that the key insight in the above proof is that scaling by polynomials don't affect the order of an entire function.

Corollary 23.2.3. *Let f be an entire function of order $\lambda \notin \mathbb{Z}$. Then f assumes each complex number an infinite number of times (hence there are no exceptional points).*

Proof. Consider $g(z) = f(z) - \alpha$, $\alpha \in \mathbb{C}$. The order of g is the same as the order of f , i.e., $\lambda \notin \mathbb{Z}$. Hence by Theorem 23.2.2, $g(z)$ has infinitely many zeros, meaning that $f(z)$ assumes α infinitely many times. \square

That is to say, order $\lambda \notin \mathbb{Z}$ guarantees the presence of the infinite product part of the Weierstrass factorisation theorem.

The question of the range of analytic functions gets much more delicate if we move from all of \mathbb{C} (so entire functions) to regions $G \neq \mathbb{C}$.

23.3 The range of an analytic function

Let $D = \{z \mid |z| < 1\}$, and suppose $f: D \rightarrow \mathbb{C}$ is analytic, with $f(0) = 0$ and $f'(0) = 1$. (By the Riemann mapping theorem we know any region $G \neq \mathbb{C}$ is conformal to D , so it suffices to study D .)

We want to investigate how 'big' $f(D)$ can be,

Lemma 23.3.1. *Let $f: D \rightarrow \mathbb{C}$ be analytic, $f(0) = 0$ and $f'(0) = 1$. Suppose $|f(z)| \leq M$ for every $z \in D$. Then $M \geq 1$ and $f(D) \supset B(0, \frac{1}{6M})$.*

Proof. First we show that $M \geq 1$. Consider the power series expansion of $f(z)$ at $z = 0$,

$$f(z) = z + a_2 z^2 + a_3 z^3 + \dots,$$

since $a_0 = f(0) = 0$ and $a_1 = f'(0) = 1$ by hypothesis. But $0 < r < 1$, Cauchy's integral formula gives us $|a_n| \leq \frac{M}{r^n} \leq M$ for all n by letting $r \rightarrow 1$.

Hence in particular $a_1 = f'(0) = 1$, so $1 \leq \frac{M}{r}$, or $r \leq M$, for $0 < r < 1$, so letting $r \rightarrow 1$ we see that $M \geq 1$.

Next let us show that $f(D) \supset B(0, \frac{1}{6M})$. For any $w \in B(0, \frac{1}{6M})$, consider the function $g(z) = f(z) - w$. We wish to show that $g(z)$ has a zero in D , since that corresponds to $w \in f(D)$.

The idea is to apply Rouché's theorem on the circle $|z| = \frac{1}{4M}$. For $|z| = \frac{1}{4M}$,

$$|f(z)| \geq |z| - \sum_{n=2}^{\infty} |a_n| |z|^n \geq \frac{1}{4M} - \sum_{n=2}^{\infty} M \left(\frac{1}{4M}\right)^n$$

since $|a_n| \leq M$ for all n . The sum at the end is geometric, and works out to be $\frac{1}{16M-4}$, so

$$|f(z)| \geq \frac{1}{4M} - \frac{1}{16M-4} \geq \frac{1}{6M}.$$

Hence on $|z| = \frac{1}{4M}$, since $w \in B(0, \frac{1}{6M})$,

$$|f(z) - g(z)| = |w| < \frac{1}{6M} \leq |f(z)|.$$

Hence by Rouché's theorem $f(z)$ and $g(z)$ have the same number of zeros in $B(0, \frac{1}{4M})$, and since $f(0) = 0$, we must consequently have $g(z) = 0$ for some $z \in B(0, \frac{1}{4M}) \subset D$, whence $w \in f(D)$ as claimed. \square

Remark 23.3.2. It is useful to note that the appearance of the constant 6 seems a bit out of the blue, and it sort of is.

As is often the case in situations like this, the way one originally discovers the theorem is to consider some constant C in place of 6, prove the theorem in some generality, and then, once done, optimise the choice of C .

The appearance of 6 only looks vaguely magical because the exposition here skips the hard work in finding it.

Heuristically, we can tell this lemma cannot be optimal: when M is large, i.e., we have a large bound on $f(z)$, so f takes on many values between 0 and M , then $B(0, \frac{1}{6M})$ is tiny. This hints at there being a better result, and indeed we will work on achieving it in the near future.

For reference we also work out what this theorem becomes on arbitrary balls centred at $z = 0$:

Lemma 23.3.3. *Suppose g is analytic on $B(0, R)$, $g(0) = 0$, and $|g'(0)| = \mu > 0$ and $|g(z)| \leq M$ for all $z \in B(0, R)$. Then $g(B(0, R)) \supset B(0, \frac{R^2 \mu^2}{6M})$.*

Proof. Consider the function $f(z) = \frac{g(Rz)}{Rg'(0)} : D \rightarrow \mathbb{C}$. We verify that $f(0) = 0$,

$$f'(0) = \frac{g'(Rz)R}{Rg'(0)} \Big|_{z=0} = \frac{g'(0)R}{Rg'(0)} = 1,$$

and $|f(z)| \leq \frac{M}{R\mu}$. Hence Lemma 23.3.1 we get

$$f(D) \supset B\left(0, \frac{1}{6\left(\frac{M}{R\mu}\right)}\right) = B\left(0, \frac{R\mu}{6M}\right),$$

so

$$g(B(0, R)) \supset B\left(0, \frac{R^2\mu^2}{6M}\right). \quad \square$$

We need one more lemma in order to prove the result we are really after.

Lemma 23.3.4. *Let f be analytic on $B(a, r)$ such that $|f'(z) - f'(a)| < |f'(a)|$ for all $z \in B(a, r)$, $z \neq a$. Then f is one-to-one.*

Proof. This is essentially the fundamental theorem of calculus. For $z_1, z_2 \in B(a, r)$, $z_1 \neq z_2$, write

$$|f(z_2) - f(z_1)| - \left| \int_{[z_1, z_2]} f'(z) dz \right|,$$

where by $[z_1, z_2]$ we mean the line segment joining z_1 and z_2 (since the ball $B(a, r)$ is convex, this line segment is in the ball). Adding and subtracting $f'(z)$ inside the integral, we get

$$\begin{aligned} |f(z_2) - f(z_1)| &= \left| \int_{[z_1, z_2]} f'(z) - f'(a) + f'(a) dz \right| \\ &\geq \left| \int_{[z_1, z_2]} f'(a) dz \right| - \left| \int_{[z_1, z_2]} f'(z) - f'(a) dz \right| \\ &> |f'(a)||z_2 - z_1| - \left| \int_{[z_1, z_2]} f'(a) dz \right| \\ &= |f'(a)||z_2 - z_1| - |f'(a)||z_2 - z_1| = 0. \end{aligned}$$

Hence $f(z_2) \neq f(z_1)$, so f is one-to-one. \square

With these lemmata we are equipped to prove the main theorem we are after, the proof of which is very technical and little lengthy:

Theorem 23.3.5 (Bloch's theorem). *Let f be an analytic function on a neighbourhood of $\bar{D} = \{z \mid |z| \leq 1\}$ such that $f(0) = 0$ and $f'(0) = 1$. Then there exists a disk $S \subset D$ such that f is one-to-one on S and $f(S)$ contains a disk of radius $\frac{1}{72}$.*

Remark 23.3.6. Note how this constant $\frac{1}{72}$, quite remarkably, is uniform in f .

Lecture 24 Bloch's and Landau's Constants

24.1 Proof of Bloch's theorem

Proof. The broad strategy is this: we want a new function with derivative as large as possible at some point a , so that we can apply Lemma 23.3.4, and

moreover we want its derivative and the upper bound of the function to be of similar size, so that in Lemma 23.3.3 we get a constant.

To this end, let

$$K(r) = \max_{|z|=r} |f'(z)|$$

and let $h(r) = (1-r)K(r)$. Then $h: [0, 1] \rightarrow \mathbb{R}$ is continuous, $h(0) = 1$ and $h(1) = 0$, by construction. Let $r_0 = \sup\{r \mid h(r) = 1\}$.

Notice three things: first, since h is continuous, $h(r_0) = 1$. Second, $0 \leq r_0 < 1$ since $h(1) = 0 \neq 1$, and third, for any $r > r_0$, $h(r) < 1$ because of the supremum.

Now take $a \in D$ with $|a| = r_0$ such that $K(r_0) = |f'(a)|$. This must be possible since the supremum on $|z| = r_0$, which is compact, must be attained. Then

$$1 = h(r_0) = (1 - r_0)K(r_0) = (1 - r_0)|f'(a)|,$$

or in other words

$$|f'(a)| = \frac{1}{1 - r_0}.$$

Our goal is to apply Lemma 23.3.4 near $z = a$, so consider a ball $B(a, \rho_0)$ where $\rho_0 := \frac{1}{2}(1 - r_0)$. Notice how this by construction means

$$(24.1.1) \quad |f'(a)| = \frac{1}{2\rho_0}.$$

Then for $|z - a| < \rho_0$, we have

$$|z| < |a| + \frac{1}{2}(1 - r_0) = r_0 + \frac{1}{2}(1 - r_0) = \frac{1}{2}(1 + r_0).$$

Notice how $r_0 < \frac{1}{2}(1 + r_0)$ since $r_0 < 1$, and how therefore $h(\frac{1}{2}(1 + r_0)) < 1$. Hence for $|z - a| < \rho_0$,

$$|f'(z)| \leq K\left(\frac{1}{2}(1 + r_0)\right) = \frac{h(\frac{1}{2}(1 + r_0))}{1 - \frac{1}{2}(1 + r_0)},$$

where the inequality in the first step is the Maximum modulus principle, and the second step is the definition of $K(r)$. Now since $h(\frac{1}{2}(1 + r_0)) < 1$, this is bounded by

$$|f'(z)| < \frac{1}{\frac{1}{2}(1 - r_0)} = \frac{1}{\rho_0}$$

for all $|z - a| < \rho_0$.

To apply Lemma 23.3.4 we want $|f'(z) - f'(a)| < |f'(a)|$, so let us compute the former: for $|z - a| < \rho_0$,

$$|f'(z) - f'(a)| \leq |f'(z)| + |f'(a)| < \frac{1}{\rho_0} + \frac{1}{2\rho_0} = \frac{3}{2\rho_0}.$$

Unfortunately this is clearly not less than $|f'(a)| = \frac{1}{2\rho_0}$ —the disk is too large—so we need to shrink ρ_0 .

Toward this, consider

$$\Psi(z) = \frac{2\rho_0}{3}(f'(\rho_0 z + a) - f'(a)),$$

so that $\Psi: D \rightarrow \mathbb{C}$. Now $\Psi(0) = 0$ and

$$|\Psi(z)| \leq \frac{2\rho_0}{3} \frac{3}{2\rho_0} = 1$$

by the above calculations, so we can apply Schwarz lemma, which tells us that $|\Psi(z)| \leq |z|$ for all $|z| \leq 1$. Consequently

$$|f'(\rho_0 z + a) - f'(a)| \leq \frac{3}{2\rho_0} |z|,$$

and making the change of variables $w = \rho_0 z + a \in B(a, \rho_0)$, so $z = \frac{w-a}{\rho_0}$, we get

$$|f'(w) - f'(a)| \leq \frac{3|w-a|}{2\rho_0^2}$$

for $w \in B(a, \rho_0)$. We want this to be less than $|f'(a)| = \frac{1}{2\rho_0}$, so

$$\frac{3|w-a|}{2\rho_0^2} < \frac{1}{2\rho_0}$$

means

$$|w-a| < \frac{1}{3}\rho_0.$$

Therefore we take $z \in S = B(a, \frac{1}{3}\rho_0)$ and there we get

$$|f'(z) - f'(a)| < \frac{3}{2\rho_0} \frac{1}{3}\rho_0 = \frac{1}{2\rho_0} = |f'(a)|,$$

so we can apply Lemma 23.3.4, guaranteeing that f is one-to-one on S .

It remains to show that $f(S)$ contains a disk of radius $\frac{1}{72}$. To accomplish this we want to apply Lemma 23.3.3, meaning that we need a function g with $g(0) = 0$, and we need information about its derivative at 0 and a bound for it on a ball.

Let $g: B(0, \frac{1}{3}\rho_0) \rightarrow \mathbb{C}$ be defined by $g(z) = f(z+a) - f(a)$, so that $g(0) = 0$ and $|g'(0)| = |f'(a)| = \frac{1}{2\rho_0}$.

To get a bound on $|g(z)|$ we need use the Fundamental theorem of calculus, since this way we can leverage our knowledge of the derivative. Consider the line segment $\gamma = [a, z+a] \subset S = B(a, \frac{1}{3}\rho_0) \subset B(a, \rho_0)$, for which

$$|g(z)| = \left| \int_{\gamma} g'(w) dw \right| \leq \int_{\gamma} |g'(w)| dw.$$

By definition $g'(w) = f'(w+a)$, and we know that $|f'(z)| < \frac{1}{\rho_0}$ for all $|z-a| < \rho_0$, and hence also $|f'(w+a)| < \frac{1}{\rho_0}$, so that

$$|g(z)| \leq \frac{1}{\rho_0} |z| < \frac{1}{\rho_0} \frac{1}{3}\rho_0 = \frac{1}{3}.$$

Therefore by Lemma 23.3.3, $g(B(0, \frac{1}{3}\rho_0)) \supset B(0, \sigma)$ with

$$\sigma = \frac{(\frac{1}{3}\rho_0)^2 (\frac{1}{2\rho_0})^2}{6 \cdot \frac{1}{3}} = \frac{\frac{1}{9} \cdot \frac{1}{4}}{2} = \frac{1}{72}.$$

Shifting back to f , this means

$$f(S) \supset B\left(f(a), \frac{1}{72}\right),$$

finishing the proof. \square

We can readily translate this to other disks centred at $z = 0$:

Corollary 24.1.1. *Let f be an analytic function on a neighbourhood of $\overline{B(0, R)}$. Then $f(B(0, R))$ contains a disk of radius $\frac{1}{72}R|f'(0)|$.*

Proof. If $f'(0) = 0$, then the result is trivially true, so assume $f'(0) \neq 0$. Consider the function

$$g(z) = \frac{f(Rz) - f(0)}{Rf'(0)},$$

where Rz serves to move us from $B(0, R)$ to D , subtracting $f(0)$ is to make $g(0) = 0$, and dividing by $Rf'(0)$ makes $g'(0) = 1$.

Hence we can apply Bloch's theorem on g , so that $g(D)$ contains a disk of radius $\frac{1}{72}$, and so $f(B(0, R))$ contains a disk of radius $\frac{1}{72}R|f'(0)|$. \square

The constant $\frac{1}{72}$ in Bloch's theorem is not best possible.

Definition 24.1.2 (Bloch's constant). Let \mathcal{F} be the set of all functions f that are analytic on a neighbourhood of $D = \{z \mid |z| < 1\}$, with $f(0) = 0$ and $f'(0) = 1$.

For each $f \in \mathcal{F}$, let $\beta(f)$ denote the supremum of all r such that there exists a disk $S \subset D$ where f is one-to-one on S and $f(S)$ contains a disk of radius r .

Bloch's constant is the number B defined by

$$B = \inf_{f \in \mathcal{F}} \{ \beta(f) \}.$$

Remark 24.1.3. Notice how Bloch's theorem implies that $B \geq \frac{1}{72}$. On the other hand, considering the function $f(z) = z$, we see that $\beta(f) = 1$, so $B \leq 1$.

The state of the art is

$$0.4332 \approx \frac{\sqrt{3}}{4} + 3 \times 10^{-4} \leq B \leq \sqrt{\frac{\sqrt{3}-1}{2}} \cdot \frac{\Gamma(\frac{1}{3})\Gamma(\frac{11}{12})}{\Gamma(\frac{1}{4})} \approx 0.4719,$$

the lower bound due to Chen and Gauthier in [CG96] and then marginally improved by Xiong in [Xio98], and the upper bound is due to Ahlfors and Grunsky in [AG37].

It is further conjectured in the Ahlfors and Grunsky paper is the true value of B .

We can ask a related, but slightly relaxed question:

Definition 24.1.4 (Landau's constant). For each $f \in \mathcal{F}$, define $\lambda(f)$ to be the supremum of all r such that $f(D)$ contains a disk of radius r . **Landau's constant** L is defined by

$$L = \inf_{f \in \mathcal{F}} \{ \lambda(f) \}.$$

Remark 24.1.5. Naturally $\lambda(f) \geq \beta(f)$ since λ drops the requirement of f being one-to-one on the disk in question. Hence since $\lambda(f) \geq \beta(f)$ for all $f \in \mathcal{F}$ we must have $B \geq L$, and as before, taking $f(z) = z$, $L \geq 1$.

The best known bounds for L are

$$0.5 < L \leq \frac{\Gamma(\frac{1}{3})\Gamma(\frac{5}{6})}{\Gamma(\frac{1}{6})} \approx 0.5433$$

Note that in particular this tells us that $B < L$, so the equality is ruled out.

Notice how, being defined by an infimum, it is possible, in principle, no function ever attains L exactly. As it happens, this is not actually the case:

Proposition 24.1.6. *Let f be analytic on a neighbourhood of \overline{D} with $f(0) = 0$ and $f'(0) = 1$. Then $f(D)$ contains a disk of radius L .*

Proof. We will show something slightly stronger, namely that $f(D)$ contains a disk of radius $\lambda = \lambda(f)$, and since $\lambda(f) \geq L$, this implies the proposition.

By the definition of $\lambda(f)$, in terms of a supremum, we have that for each $n \in \mathbb{N}$ there exists some $\alpha_n \in f(D)$ such that $f(D) \supset B(\alpha_n, \lambda - \frac{1}{n})$.

Notice now how $\{\alpha_n\} \subset f(D) \subset f(\overline{D})$. Crucially, \overline{D} is compact, and f is continuous, whence maps compact sets to compact sets, so $f(\overline{D})$ is compact. Therefore $\{\alpha_n\}$ has a limit point.

For instance, take a subsequence $\{\alpha_{n_k}\}$ such that $\alpha_{n_k} \rightarrow \alpha \in f(\overline{D})$. Then we claim that $f(D) \supset B(\alpha, \lambda)$.

This is an exercise in the triangle inequality: for $w \in B(0, \lambda)$, choose M large enough so that $|w - a| < \lambda - \frac{1}{M}$.

Since $\alpha_{n_k} \rightarrow \alpha$, there must exist some $N \in \mathbb{N}$ large enough so that $N > 2M$ and for $n_k > N$, $|\alpha_{n_k} - \alpha| < \frac{1}{2M}$. Then

$$|w - \alpha_{n_k}| \leq |w - \alpha| + |\alpha - \alpha_{n_k}| < \lambda - \frac{1}{M} + \frac{1}{2M} = \lambda - \frac{1}{2M} < \lambda - \frac{1}{n_k}$$

since $2M < N < n_k$. Hence $w \in B(\alpha_{n_k}, \lambda - \frac{1}{n_k}) \subset f(D)$, so $B(\alpha, \lambda) \subset f(D)$. \square

Again we can translate this to arbitrary disks centred on $z = 0$ (by exactly the same method Corollary 24.1.1):

Corollary 24.1.7. *Let f be analytic on a neighbourhood of $\overline{B(0, R)}$. Then $f(B(0, R))$ contains a disk of radius $|f'(0)|RL$.*

Proof. As in Corollary 24.1.1, $f'(0) = 0$ is trivial, so assume $f'(0) \neq 0$ and consider

$$g(z) = \frac{f(Rz) - f(0)}{Rf'(0)},$$

applying the Proposition 24.1.6. \square

24.2 The Little Picard theorem

We showed, as a consequence of Hadamard's factorisation theorem, a Special case of Picard's theorem, saying that a non-constant entire function of finite order can miss at most one point in \mathbb{C} . Our next goal is to show that the assumption of finite order is not necessary.

To accomplish this we need the following small calculation:

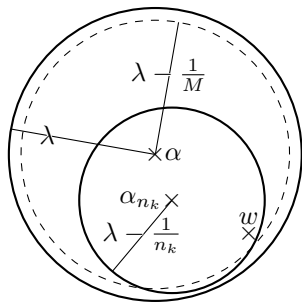

Figure 24.1.1: The setup of α , w , and α_{n_k} .

Lemma 24.2.1. *Let G be a simply connected region. Let $f: G \rightarrow \mathbb{C}$ be analytic. Suppose f does not assume the values 0 or 1. Then there exists an analytic function $g: G \rightarrow \mathbb{C}$ such that*

$$f(z) = -\exp(\pi i \cosh(2g(z)))$$

for all $z \in G$.

It is worth recalling here that

$$\cosh(z) := \frac{e^z + e^{-z}}{2}.$$

Proof. The proof essentially boils down to solving the expression for $f(z)$ above for $g(z)$, then working backwards.

Since f does not vanish on G , which is simply connected, we can take logarithms. By way of saying, there exists some analytic $h: G \rightarrow \mathbb{C}$ such that $f(z) = \exp(h(z))$.

Let $F(z) = \frac{1}{2\pi i} h(z)$, and notice how for any $n \in \mathbb{Z}$, we have $F(z) \neq n$ for all $z \in G$. If not, $h(z) = 2\pi i n$, implying that $f(z) = \exp(h(z)) = 1$, which is a contradiction.

In particular, $F(z)$ does not assume 0 or 1, so both $F(z)$ and $F(z) - 1$ have analytic square roots, so we can define

$$H(z) = \sqrt{F(z)} - \sqrt{F(z) - 1},$$

analytic on G . Moreover $H(z) \neq 0$ for all $z \in G$, since otherwise we would have $0 = \sqrt{F(z)} - \sqrt{F(z) - 1}$, which rearranged and squared gives us $0 = 1$.

So there exists, finally, an analytic $g: G \rightarrow \mathbb{C}$ such that $H(z) = \exp(g(z))$, and therefore, retracing our steps,

$$\begin{aligned} \cosh(2g(z)) + 1 &= \frac{e^{2g(z)} + e^{-2g(z)}}{2} + 1 = \frac{(e^{g(z)} + e^{-g(z)})^2}{2} \\ &= \frac{(H(z) + \frac{1}{H(z)})^2}{2} = 2F(z) = \frac{1}{\pi i} h(z). \end{aligned}$$

Hence

$$f(z) = \exp(h(z)) = \exp(\pi i (\cosh(2g(z)) + 1)) = -\exp(\pi i \cosh(2g(z)))$$

by pulling out the factor of $\exp(\pi i) = -1$. □

Lecture 25 Toward the Little Picard Theorem

25.1 Another lemma

As a consequence of Lemma 24.2.1 we have the following related result:

Lemma 25.1.1. *Let G be a simply connected region. Let $f: G \rightarrow \mathbb{C}$ be analytic. Suppose f does not assume the values 0 or 1. (In other words, G , f , and g as in Lemma 24.2.1.)*

Then $g(G)$ contains no disk of radius 1.

Proof. First, let us show that $g(z)$ does not assume any values of

$$A = \left\{ \pm \log(\sqrt{n} + \sqrt{n-1}) + \frac{1}{2}im\pi \mid \mathbb{Z} \ni n \geq 1, m = 0, \pm 1, \pm 2, \dots \right\}.$$

This is a simple computation. If $g(z) = \pm \log(\sqrt{n} + \sqrt{n-1}) + \frac{1}{2}im\pi$ for some $z \in G$, then

$$\begin{aligned} 2 \cosh(2g(z)) &= e^{2g(z)} + e^{-2g(z)} \\ &= e^{im\pi(\sqrt{n} + \sqrt{n-1})^{\pm 2}} + e^{-im\pi(\sqrt{n} + \sqrt{n-1})^{\mp 2}} \\ &= (-1)^m((\sqrt{n} + \sqrt{n-1})^2 + (\sqrt{n} - \sqrt{n-1})^2) \\ &= (-1)^m(2 \cdot (2n-1)). \end{aligned}$$

Hence $f(z) = -\exp(\pi i(-1)^m(2n-1)) = 1$, which contradicts Lemma 24.2.1.

Now the points in A form the vertices of a grid of rectangles in the plane with width

$$\log(\sqrt{n+1} + \sqrt{n}) - \log(\sqrt{n} + \sqrt{n-1}) < 1$$

since it is a decreasing function in n and at $n = 1$ it is $\log(\sqrt{2} + 1) \approx 0.88 < 1$.

The height of the rectangles are $\frac{1}{2}\pi$, so the diameter of the rectangles is bounded by

$$\sqrt{1^2 + \left(\frac{1}{2}\pi\right)^2} \approx 1.86 < 2,$$

so any disk of radius 1 or bigger (hence diameter 2 or bigger) must contain at least one of the points in A , and hence $f(G)$ cannot contain any such disk. \square

Lecture 26 The Little Picard Theorem

26.1 Proof of the Little Picard theorem

With these two lemmata in hand we are equipped to prove

Theorem 26.1.1 (Little Picard theorem). *Let f be an entire function. Suppose f misses two values in \mathbb{C} . Then f is a constant function.*

Proof. Suppose $f(z) \neq a$ and $f(z) \neq b$ for all $z \in \mathbb{C}$, with $a \neq b$ —that is, f misses a and b . Then we can normalise to $\tilde{f}(z) = \frac{f(z)-a}{b-a}$ which misses 0 and 1. Hence by Lemma 24.2.1 we can write

$$\tilde{f}(z) = -\exp(\pi \cosh(2g(z)))$$

for some entire function g , and by Lemma 25.1.1 we know that $g(\mathbb{C})$ contains no disk of radius 1.

By way of contradiction, suppose f is not constant, meaning that g is not constant. A non-constant entire function must have some nonzero derivative (else its power series, which converges everywhere, is zero), so there exists some $z_0 \in \mathbb{C}$ such that $g'(z_0) \neq 0$. For convenience we may assume $z_0 = 0$, so $g'(0) \neq 0$ (else shift to $\tilde{g}(z) = g(z + z_0)$).

Now by Corollary 24.1.1 of Bloch's theorem, $g(B(0, R))$ contains a disk of radius $\frac{1}{72}R|g'(0)|$. But since $g'(0) \neq 0$, this goes to infinity as $R \rightarrow \infty$, so we can pick R large enough so that $g(\mathbb{C}) \supset g(B(0, R))$ contains a disk of radius 1, contradicting Lemma 25.1.1.

Hence f is constant, finishing the proof. \square

Exercise 26.1. Let f be a meromorphic function on \mathbb{C} such that $f(\mathbb{C}) \setminus f(\mathbb{C})$ has at least three points. Show that f is constant. \blacksquare

26.2 Schottky's theorem

As a consequence of Hadamard's factorisation theorem we showed a Special case of Picard's theorem, saying that a non-constant entire function of finite order assumes each complex number with only one possible exception. Little Picard theorem above tells us that the assumption of finite order is not necessary.

From Hadamard's factorisation theorem we also inferred Corollary 23.2.3, saying that an entire function of finite, non-integral order assumes each complex number an infinite number of times. We wish to generalise this result too.

The strategy boils down to that of Lemma 24.2.1, but with slightly more care taken, to derive precise bounds. In particular, the way we constructed the function g coming from $f: G \rightarrow \mathbb{C}$, analytic and missing 0 and 1, was to take $h(z)$ to be a branch of $\log f(z)$ (i.e., $e^{h(z)} = f(z)$), set $F(z) = \frac{1}{2\pi i} h(z)$, and take $H(z) = \sqrt{F(z)} - \sqrt{F(z) - 1}$. Then we finally took $g(z)$ to be a branch of $\log H(z)$, i.e., $e^{g(z)} = H(z)$.

The way we are going to make this more precise is to specify the branches at each of these stages. In particular, we will take $0 \leq \text{Im } h(0) \leq 2\pi$ and $0 \leq \text{Im } g(0) \leq 2\pi$.

Theorem 26.2.1 (Schottky's theorem). *Let f be analytic on some simply connected region containing $B(0, 1)$, and suppose $f(z)$ misses 0 and 1.*

Then for each α and β , $0 < \alpha < \infty$ and $0 \leq \beta < 1$, there exists a constant $C(\alpha, \beta)$ such that if $|f(0)| < \alpha$, then $|f(z)| \leq C(\alpha, \beta)$ for $|z| \leq \beta$.

Remark 26.2.2. Notice how this constant $C(\alpha, \beta)$ is independent of f —this gives a uniform bound for all functions f so long as $|f(0)| < \alpha$.

Proof. As outlined in the discussion above, the strategy is to perform the calculations in Lemma 24.2.1 to obtain a bound for g depending only on α and β , and then leverage this to bound f likewise.

As will soon become apparent, the calculations are easier if $2 \leq \alpha < \infty$, but of course if $|f(0)| < \gamma$ for some $\gamma \leq 2$, then it is also bounded by α , so it suffices to study such α .

We will consider two cases: when $f(0)$ has a lower bound, namely $\frac{1}{2} \leq |f(0)| \leq \alpha$, and when $0 < |f(0)| < \frac{1}{2}$.

Start by supposing $\frac{1}{2} \leq |f(0)| \leq \alpha$. Let h , F , H , and g be defined as in Lemma 24.2.1. Then by definition

$$\begin{aligned} |F(0)| &= \frac{1}{2\pi} |h(0)| = \frac{1}{2\pi} |\log f(0)| = \frac{1}{2\pi} |\log|f(0)|| + i \text{Im } \log f(0) \\ &= \frac{1}{2\pi} |\log|f(0)|| + i \text{Im } h(0) \leq \frac{1}{2\pi} (|\log|f(0)|| + 2\pi) \end{aligned}$$

by choice of the branch $0 \leq \operatorname{Im} h(0) \leq 2\pi$. But $\frac{1}{2} \leq |f(0)| \leq \alpha$, so $-\log 2 \leq \log|f(0)| \leq \log \alpha$, and hence $|\log|f(0)|| \leq 2 \leq \alpha$. Therefore

$$|F(0)| \leq \frac{1}{2\pi}(\log \alpha + 2\pi) = C_0(\alpha).$$

Next, we have by the triangle inequality that

$$|\sqrt{F(0)} \pm \sqrt{F(0) - 1}| \leq |\sqrt{F(0)}| + |\sqrt{F(0) - 1}|$$

Notice in general, writing $\sqrt{z} = \exp(\frac{1}{2} \log z)$, we have

$$|\sqrt{z}| = \exp\left(\frac{1}{2} \operatorname{Re} \log z\right) = \exp\left(\frac{1}{2} \log|z|\right) = \sqrt{|z|},$$

so we can bring the modulus inside, whence

$$|\sqrt{F(0)} \pm \sqrt{F(0) - 1}| \leq |F(0)|^{\frac{1}{2}} + |F(0) - 1|^{\frac{1}{2}} \leq C_0(\alpha)^{\frac{1}{2}} + (C_0(\alpha) + 1)^{\frac{1}{2}}.$$

Now let $C_1(\alpha) = C_0(\alpha)^{\frac{1}{2}} + (C_0(\alpha) + 1)^{\frac{1}{2}}$ so that $|\sqrt{F(0)} \pm \sqrt{F(0) - 1}| \leq C_1(\alpha)$.

There are two cases to consider here: if $|H(0)| \geq 1$, then

$$|g(0)| = |\log|H(0)| + i \operatorname{Im} g(0)| \leq |\log|H(0)|| + 2\pi,$$

since we chose $0 \leq \operatorname{Im} g(0) \leq 2\pi$. Hence in particular

$$|g(0)| \leq \log C_1(\alpha) + 2\pi$$

since $|H(0)| \geq 1$. On the other hand, if $|H(0)| < 1$, then

$$\begin{aligned} |g(0)| &\leq -\log|H(0)| = 2\pi = \log\left|\frac{1}{H(0)}\right| + 2\pi \\ &= \log|\sqrt{F(0)} + \sqrt{F(0) - 1}| + 2\pi \leq \log C_1(\alpha) + 2\pi, \end{aligned}$$

so we get the same bound. Thus let $C_2(\alpha) = \log C_1(\alpha) + 2\pi$, so that $|g(0)| \leq C_2(\alpha)$.

In other words, we now have control of $g(0)$.

By shifting the function in Corollary 24.1.1 of Bloch's theorem, for $|a| < 1$ we see $g(B(a, 1 - |a|))$ contains a disk of radius $\frac{1}{72}|g'(a)|(1 - |a|)$.

On the other hand, by Lemma 25.1.1, $g(B(0, 1))$ contains no disk of radius 1, so we must have

$$\frac{1}{72}|g'(a)|(1 - |a|) < 1,$$

meaning that we can control the derivative:

$$|g'(a)| < \frac{72}{1 - |a|}$$

for any $|a| < 1$.

The idea now is that, since we have control of the function g at a point (namely 0) and we have control of its derivative, we can the function at any

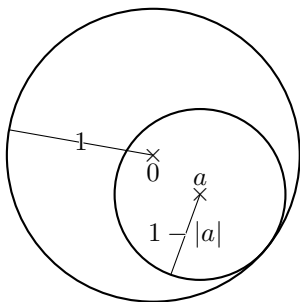

Figure 26.2.1: The setup of a in the unit disk.

point by means of the Fundamental theorem of calculus. In particular, for $|a| < 1$ we have

$$\begin{aligned} |g(a)| &\leq |g(0)| + |g(a) - g(0)| \leq C_2(\alpha) + \left| \int_{[0,a]} g'(z) dz \right| \\ &\leq C_2(\alpha) + |a| \max_{z \in [0,a]} |g'(z)| \leq C_2(\alpha) + |a| \frac{72}{1 - |a|}. \end{aligned}$$

So if we let

$$C_3(\alpha, \beta) = C_2(\alpha) + \frac{72\beta}{1 - \beta}$$

for $0 \leq \beta < 1$, we have for all $|z| \leq \beta$ that

$$|g(z)| \leq C_2(\alpha) + \frac{72|z|}{1 - |z|} \leq C_3(\alpha, \beta)$$

since the expression $\frac{72|z|}{1 - |z|}$ is increasing in $|z| < 1$. Notice how this bound is uniform—it doesn't depend on g .

Consequently, we get

$$|f(z)| = |\exp(\pi i \cosh(2g(z)))| \leq C(\alpha, \beta)$$

for a corresponding constant $C(\alpha, \beta)$ independent of f .

This leaves the case when $0 < |f(0)| < \frac{1}{2}$. In this case, consider $1 - f(z)$, which misses 0 and 1 since $f(z)$ does. Then $\frac{1}{2} \leq |1 - f(0)| \leq \frac{3}{2}$, so taking $\alpha = \frac{3}{2}$ and applying the previous case, we get

$$|1 - f(z)| \leq C(\alpha, \beta)$$

for all $|z| \leq \beta$, and $|1 - f(z)| \geq |f(z)| - 1$, meaning that

$$|f(z)| \leq 1 + C(\alpha, \beta)$$

for all $|z| \leq \beta$. □

As is now our custom, we can easily generalise results on the unit ball to results on larger balls:

Corollary 26.2.3. *Let f be analytic on a simply connected region containing $\overline{B(0, R)}$. Suppose $f(z)$ misses 0 and 1, and $|f(0)| \leq \alpha$. Let $C(\alpha, \beta)$ be the constant in Schottky's theorem. Then $|f(z)| \leq C(\alpha, \beta)$ for all $|z| \leq \beta R$.*

Proof. Consider $f(Rz)$ for $|z|$ and apply Schottky's theorem. □

Lecture 27 The Great Picard Theorem

27.1 The range of entire functions, revisited

The Great Picard theorem will follow almost immediately from the following slightly technical theorem:

Date: November 19th, 2019.

Theorem 27.1.1 (Montel–Carathéodory theorem). *Let G be a region. Let*

$$\mathcal{F} = \{ f: G \rightarrow \mathbb{C} \text{ analytic} \mid f(z) \text{ omits } 0 \text{ and } 1 \}.$$

Then \mathcal{F} is normal in $C(G, \mathbb{C}_\infty)$.

Proof. Fix $z_0 \in G$ and let $\mathcal{G} = \{ f \in \mathcal{F} \mid |f(z)| \leq 1 \}$ and $\mathcal{H} = \{ f \in \mathcal{F} \mid |f(z)| > 1 \}$. Then $\mathcal{F} = \mathcal{G} \cup \mathcal{H}$ and if we can show that \mathcal{G} and \mathcal{H} are normal in $C(G, \mathbb{C}_\infty)$, then so is \mathcal{F} .

We will show in particular that \mathcal{G} is normal in $H(G)$, and \mathcal{H} is normal in $C(G, \mathbb{C}_\infty)$, one at a time.

First, to show that \mathcal{G} is normal in $H(G)$, recall how by Montel’s theorem it suffices to show that \mathcal{G} is locally bounded.

To this end, let $a \in G$ and let γ be a path from z_0 to a . Take disks $\overline{D_0}, \overline{D_1}, \dots, \overline{D_n}$ in G , centred at $z_0, z_1, \dots, z_n = a \in \{\gamma\}$, so that $z_{k-1}, z_k \in D_{k-1} \cup D_k$ for all $1 \leq k \leq n$. This is possible by taking z_{k-1} and z_k sufficiently close to one another, and since γ is compact, we can find a finite subset of them that does the job.

Now by applying a shifted version of Schottky’s theorem on D_0 , we see that there exists some constant C_0 such that $|f(z)| \leq C_0$ for all $z \in D_0$ and all $f \in \mathcal{G}$.

In particular, since by construction $z_1 \in D_0$, this gives us $|f(z_1)| \leq C_0$ for all $f \in \mathcal{G}$. This lets us apply Schottky’s theorem again to D_1 , whence $|f(z)| \leq C_1$ for all $f \in \mathcal{G}$ and all $z \in D_1$ for some constant C_1 , and in particular $|f(z_2)| \leq C_1$ for all $f \in \mathcal{G}$.

Repeat this argument on D_2, D_3 , and so on, until we get for D_n that \mathcal{G} is uniformly bounded on $D_n = B(a, r)$ for some radius r . Hence \mathcal{G} is locally bounded, since $a \in G$ is arbitrary, and therefore \mathcal{G} is normal.

This leaves showing that \mathcal{H} is normal in $C(G, \mathbb{C}_\infty)$. If $f \in \mathcal{H}$ is analytic, then $\frac{1}{f}$ is analytic on G (since f omits zero, being bounded below by 1). Moreover, $\frac{1}{f(z)} \neq 0$ since f is analytic, hence having no poles, and $\frac{1}{f(z)} \neq 1$ since $f(z) \neq 1$. Finally, $|\frac{1}{f(z)}| < 1$ since $|f(z)| > 1$.

All by way of saying: $\tilde{\mathcal{H}} := \{ \frac{1}{f} \mid f \in \mathcal{H} \} \subset \mathcal{G}$. Since \mathcal{G} is normal, $\tilde{\mathcal{H}}$ must be normal too.

In other words, if $\{ f_n \} \subset \mathcal{H}$, then there exists a subsequence $\{ f_{n_k} \}$ such that $\frac{1}{f_{n_k}} \rightarrow h \in H(G)$.

By Corollary 14.1.4 of Hurwitz’s theorem, this means either $h = 0$ identically or $h(z) \neq 0$ for all $z \in G$. In the first case we get $f_{n_k} \rightarrow \infty$ in $C(G, \mathbb{C}_\infty)$, and in the second case we see that $\frac{1}{h}$ is analytic on G , and $f_{n_k} \rightarrow \frac{1}{h}$ in $H(G)$, so in particular in $C(G, \mathbb{C}_\infty)$. In either case we have a subsequence of $\{ f_n \} \subset \mathcal{H}$ converging in $C(G, \mathbb{C}_\infty)$, so \mathcal{H} is normal. \square

With this in hand we are equipped to prove

Theorem 27.1.2 (Great Picard theorem). *Let G be a region and $a \in G$. Let f be analytic on $G \setminus \{a\}$ and suppose g has an essential singularity at $z = a$. Then in each neighbourhood of $z = a$, $f(z)$ assumes each complex number, with one possible exception, infinitely many times.*

Remark 27.1.3. This improves the Casorati–Weierstrass theorem, which says that the image of each neighbourhood of an essential singularity is dense in \mathbb{C} .

Proof. Without loss of generality, assume f has an essential singularity at $z = 0$ (else shift it). Suppose there exists some $R > 0$ such that $f(z)$ omits two values on $0 < |z| < R$. Again we can assume those two values are 0 and 1, i.e., $f(z) \neq 0$ and $f(z) \neq 1$ for all $0 < |z| < R$, else normalise as in the proof of the Little Picard theorem.

Let $G = B(0, R) \setminus \{0\}$ and define $f_n: G \rightarrow \mathbb{C}$ by $f_n(z) = f(\frac{z}{n})$. Then f_n is analytic on G since f is and $f_n(z) \neq 0$ for all $z \in G$ since $f(z) \neq 0$ on G .

By Montel–Carathéodory theorem, $\{f_n\}$ is normal in $C(G, \mathbb{C}_\infty)$, meaning that there exists a subsequence $\{f_{n_k}\}$ such that $f_{n_k} \rightarrow \varphi$ in $C(G, \mathbb{C}_\infty)$. In particular, $f_{n_k} \rightarrow \varphi$ uniformly on any compact subset of G , so in particular on $|z| = \frac{1}{2}R$.

Note how, since $\{f_{n_k}\} \subset H(G)$, we have again by Corollary 14.1.4 of Hurwitz’s theorem that either φ is analytic on G or $\varphi = \infty$ identically.

In the former case, let

$$M = \max_{|z|=\frac{1}{2}R} |\varphi(z)|,$$

which exists since φ is analytic and $|z| = \frac{1}{2}R$ is compact. Then for $|z| = \frac{1}{2}R$,

$$\left| f\left(\frac{z}{n_k}\right) \right| = |f_{n_k}(z)| \leq |f_{n_k}(z) - \varphi(z)| + |\varphi(z)|.$$

The first term in the right-hand side goes to 0 uniformly, and the second term is bounded uniformly by M , so for n_k sufficiently large we have $|f(\frac{z}{n_k})| \leq 2M$.

Hence $|f(z)| \leq 2M$ for $|z| = \frac{R}{2n_k}$ for n_k large, so $f(z)$ is uniformly bounded on $B(0, r) \setminus \{0\}$ for some $0 < r < R$. This means $f(z)$ has a removable singularity at $z = 0$, which is a contradiction.

Similarly, in the latter case, assume $\varphi = \infty$. In this case, $f_{n_k} \rightarrow \infty$ uniformly on $|z| = \frac{1}{2}R$, which means $f(\frac{z}{n_k}) \rightarrow \infty$ uniformly on $|z| = \frac{1}{2}R$. In other words,

$$\lim_{z \rightarrow \infty} |f(z)| = \infty,$$

meaning that f has a pole at $z = 0$, which is again a contradiction.

Hence f cannot omit two values in \mathbb{C} , meaning it can omit *at most* one value.

For the second part of the theorem we need to show that, apart from this possible exceptional point, all points are attained infinitely many times.

Suppose, therefore, that two values are assumed by f only finitely many times. This means that there are some finite set of preimages of those two points in G , which in turn means we must be able to find some sufficiently small punctured disk $B(0, r) \setminus \{0\}$, $0 < r < R$, not containing any of those preimages. Hence on this smaller punctured disk, f omits those two values, which by the previous discussion is impossible. \square

An immediate corollary of this is

Corollary 27.1.4. *If f has an isolated singularity at $z = 0$ and if there are two values that are not assumed by $f(z)$ infinitely many times, then $z = a$ is either a pole or a removable singularity (i.e., $z = a$ cannot be an essential singularity).*

An almost as immediate corollary, and the result we promised a bit ago, is this:

Corollary 27.1.5. *If f is an entire function that is not a polynomial, then $f(z)$ assumes every complex number, with one possible exception, infinitely many times.*

Exercise 27.1. Suppose f is a one-to-one entire function. Show that $f(z) = az + b$ for some $a, b \in \mathbb{C}$ with $a \neq 0$. ■

Proof. Since f is entire and not a polynomial, it has a power series expansion about $z = 0$ that never ends. Consequently, the Laurent expansion of $g(z) = f(\frac{1}{z})$ extends infinitely in the negative direction, so g has an essential singularity at $z = 0$.

Therefore by the Great Picard theorem $g(z)$ assumes each complex number, with one possible exception, infinitely many times. But f and g have the same image, so $f(z)$ does too. □

27.2 Runge's theorem

Recall how in real analysis, Weierstrass theorem says that every continuous function f on a compact set in \mathbb{R} can be approximated uniformly by polynomials. (One way to prove this is by way of harmonic analysis: show that they can be approximated by Fourier series, i.e., linear combinations of trigonometric functions, and then approximate those trigonometric functions by their Taylor polynomials).

A natural question to ask, then, is this: let $K \subset \mathbb{C}$ be compact and let G be a neighbourhood of K . Suppose $f \in H(G)$. Can f be approximated uniformly by polynomials on K ?

The answer, in general, is no. Consider the following two examples:

Example 27.2.1. Let $G = B(0, R)$. For any $f \in H(G)$, we have a power series expansion

$$f(z) = \sum_{n=0}^{\infty} a_n z^n,$$

which converges uniformly on any compact subset $K \subset G$. Taking the partial sums

$$P_k(z) = \sum_{n=0}^k a_n z^n,$$

we then have $P_k \rightarrow f$ uniformly on K as $k \rightarrow \infty$. Hence in this particular case, the answer to the above question is yes. ▲

On the other hand,

Example 27.2.2. Let $G = B(0, R) \setminus \{0\}$, and let $f(z) = \frac{1}{z} \in H(G)$ (it is holomorphic since G specifically excludes the pole). Let $K = \{z \mid |z| = \frac{1}{2}R\} \subset G$, which is compact.

For any polynomial $P(z)$,

$$\int_K P(z) dz = 0$$

since K encloses no pole of $P(z)$ (it has no poles). On the other hand,

$$\int_K f(z) dz = \int_K \frac{1}{z} dz = 2\pi i$$

since K encloses the pole at $z = 0$ of f .

Now if $P_n \rightarrow f$ uniformly on K , we must have

$$\int_K P_n(z) dz \rightarrow \int_K f(z) dz$$

but the left-hand side is constantly 0, and the right-hand side is $2\pi i \neq 0$, so f cannot be approximated uniformly by polynomials on K . ▲

What these examples show is that, in fact, whether f can be approximated uniformly by polynomials or not is a topological property: it depends on whether $\mathbb{C} \setminus K$ is connected or not.

What Runge's theorem says is this, which we will work toward proving:

- (i) If $f \in H(G)$, then f can be approximated uniformly by *rational functions* on K ; and
- (ii) If $\mathbb{C} \setminus K$ is connected, then $f \in H(G)$ can be approximated uniformly by *polynomials* on K .

Lecture 28 Mittag-Leffler's Theorem

28.1 Runge's theorem

We will prove Runge's theorem, outlined above, in three steps.

Proposition 28.1.1. *Let G be a region and let $K \subset G$ be compact. Then there exists finitely many segments $\gamma_1, \gamma_2, \dots, \gamma_n$ in $G \setminus K$ (depending only on G and K) such that for any $f \in H(G)$,*

$$f(z) = \sum_{k=1}^n \frac{1}{2\pi i} \int_{\gamma_k} \frac{f(w)}{w-z} dw$$

for all $z \in K$.

Proof. Let $\delta := c \cdot d(K, G \setminus K) > 0$ with $0 < c < \frac{1}{2}$. Consider a grid of squares with sides parallel to the axes and of side lengths δ .

Let $\mathcal{R} = \{R_1, R_2, \dots, R_m\}$ denote the squares intersecting K —there are only finitely many such squares since K is compact.

Let $\gamma_1, \gamma_2, \dots, \gamma_n$ denote the sides of squares in \mathcal{R} that do not belong to any adjacent squares in \mathcal{R} . This has two implications: first, by the choice of δ , $\{\gamma_k\} \subset G$, since the distance from any point on γ_k to K is less than δ ; and second, $\gamma_k \cap K = \emptyset$, since otherwise γ_k belongs to two squares intersecting K .

Finally, assign each square in \mathcal{R} positive orientation, so that integration over adjacent squares cancels on the common side.

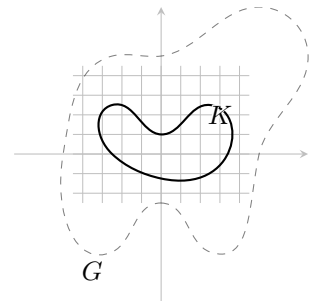

Figure 28.1.1: A square grid covering G .

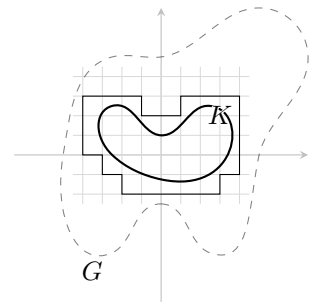

Figure 28.1.2: Constructing the γ_k from the square grid.

Now for each $z \in K$ that is not on the boundary of R_j , $1 \leq j \leq m$, there exists some j_0 such that $z \in R_{j_0}$. By Cauchy's integral formula this means

$$\frac{1}{2\pi i} \int_{\partial R_j} \frac{f(w)}{w-z} dw = \begin{cases} f(z), & \text{if } j = j_0, \\ 0, & \text{if } j \neq j_0. \end{cases}$$

If R_i and R_j are adjacent, then as discussed the integral over their common side is cancelled, so

$$f(z) = \sum_{k=1}^m \frac{1}{2\pi i} \int_{\partial R_k} \frac{f(w)}{w-z} dw = \sum_{k=1}^n \frac{1}{2\pi i} \int_{\gamma_k} \frac{f(w)}{w-z} dw$$

for $z \in K \setminus (\bigcup_{k=1}^m \partial R_k)$. But the above expression is holomorphic on (a neighbourhood) of K since all poles are in γ_k , which are outside K , and the equation holds on a dense subset of K , so it holds everywhere in K . \square

Our goal is to approximate $f \in H(G)$ by a rational function on K . The expression we end up at above,

$$f(z) = \sum_{k=1}^n \frac{1}{2\pi i} \int_{\gamma_k} \frac{f(w)}{w-z} dw,$$

is close to a rational function: it is the integral of a rational function in z . The idea is to write this as a Riemann sum:

Lemma 28.1.2. *Let G be a region and $K \subset G$ compact. Let γ be a line segment in $G \setminus K$. Then for any $\varepsilon > 0$, there exists a rational function $R(z)$ with all poles on γ such that*

$$\left| \int_{\gamma} \frac{f(w)}{w-z} dw - R(z) \right| < \varepsilon$$

for all $z \in K$.

Proof. We parametrise $\gamma: [0, 1] \rightarrow \mathbb{C}$. Then

$$\int_{\gamma} \frac{f(w)}{w-z} dw = \int_0^1 \frac{f(\gamma(t))}{\gamma(t)-z} \gamma'(t) dt.$$

Define $F: K \times [0, 1] \rightarrow \mathbb{C}$ by

$$F(z, t) = \frac{f(\gamma(t))}{\gamma(t)-z} \gamma'(t).$$

Note that since $\gamma \in G \setminus K$, $\gamma(t) \neq z$ for $z \in K$, so F is continuous. Now since $K \times [0, 1]$ is compact, F is moreover uniformly continuous on $K \times [0, 1]$. So for any $\varepsilon > 0$ there exists some $\delta > 0$ such that if $|s - t| < \delta$, then

$$|F(z, s) - F(z, t)| < \varepsilon.$$

Now approximate the integral we are interested in—the integral of $F(z, t)$ —by Riemann sums.

Choose a partition

$$0 = t_0 < t_1 < t_2 < \dots < t_n = 1$$

with $t_{i-1} - t_i < \delta$ for all $i = 0, 1, \dots, n - 1$. Define

$$R(z) = \sum_{i=0}^{n-1} F(z, t_i)(t_{i+1} - t_i) = \sum_{i=0}^{n-1} \frac{f(\gamma(t_i))}{\gamma(t_i) - z} \gamma'(t_i)(t_{i+1} - t_i),$$

the left Riemann sum of the integral at hand. This is a finite sum of rational functions in z , so it is rational with all poles on γ .

Moreover

$$\left| \int_{\gamma} \frac{f(w)}{w - z} dw - R(z) \right| = \left| \sum_{n=0}^{n-1} \int_{t_i}^{t_{i+1}} \left(\frac{f(\gamma(t))}{\gamma(t) - z} \gamma'(t) - \frac{f(\gamma(t_i))}{\gamma(t_i) - z} \gamma'(t_i) \right) dt \right|,$$

where the length in the Riemann sum has been absorbed by the integral. The integrand above is really just $F(z, t) - F(z, t_i)$, and $|t - t_i| < \delta$, so it is bounded by ε , whence

$$\left| \int_{\gamma} \frac{f(w)}{w - z} dw - R(z) \right| \leq \sum_{i=0}^{n-1} \int_{t_i}^{t_{i+1}} \varepsilon dt = \varepsilon. \quad \square$$

Hence this finishes the first part of Runge's theorem: every holomorphic function f can be approximated by rational functions on K with poles outside K .

In $\mathbb{C} \setminus K$ we want to push the poles of ∞ , since we can think of a polynomial as a rational function with poles at ∞ .

Lemma 28.1.3. *Let G be a region and $K \subset G$ compact such that $\mathbb{C} \setminus K$ is connected. Let $a \in G \setminus K$. Then $\frac{1}{z-a}$ can be approximated uniformly by polynomials on K . (That is, for any $\varepsilon > 0$ there exists a polynomial $P(z)$ such that $|\frac{1}{z-a} - P(z)| < \varepsilon$ for all $z \in K$.)*

Proof. Since K is compact, and hence bounded, there exists some $M > 0$ such that $|z| < M$ for every $z \in K$.

For any $b \in \mathbb{C}$ with $|b| > M$ and $z \in K$, we have, since $|\frac{z}{b}| < 1$,

$$\frac{1}{z-b} = -\frac{1}{b} \frac{1}{1 - \frac{z}{b}} = -\frac{1}{b} \sum_{n=0}^{\infty} \left(\frac{z}{b}\right)^n$$

converges uniformly on K .

Taking partial sums we then see that $\frac{1}{z-b}$ can be approximated uniformly by polynomials.

The strategy now is to approximate $\frac{1}{z-a}$, where $a \in G \setminus K$ is arbitrary, uniformly on K by polynomials in $\frac{1}{z-b}$.

Since $\mathbb{C} \setminus K$ is connected, there exists a path γ in $\mathbb{C} \setminus K$ from a to b . Let $\delta = \frac{1}{2}d(K, \gamma)$.

Choose a partition $a = z_0, z_1, z_2, \dots, z_n = b \in \{\gamma\}$ such that $|z_i - z_{i+1}| < \delta$ for all $i = 0, 1, \dots, n - 1$. Then for $z \in K$ we have

$$\frac{1}{z-a} = \frac{1}{z-z_0} = \frac{1}{z-z_1} \frac{1}{1 - \frac{z_0-z_1}{z-z_1}}.$$

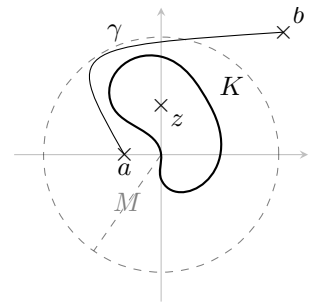

Figure 28.1.3: Connecting a and b avoiding K .

By construction and choice of δ ,

$$\left| \frac{z_0 - z_1}{z - z_1} \right| \leq \frac{\delta}{d(z, K)} \leq \frac{1}{2},$$

so that

$$\frac{1}{z - a} = \frac{1}{z - z_1} \sum_{n=0}^{\infty} \left(\frac{z_0 - z_1}{z - z_1} \right)^n$$

converges uniformly on K . Taking partial sums, this means we can approximate $\frac{1}{z-a}$ uniformly in K by polynomials in $\frac{1}{z-z_1}$. Repeating this argument with z_1 in place of $z_0 = a$, we can approximate $\frac{1}{z-z_1}$ uniformly on K by polynomials in $\frac{1}{z-z_2}$, and so on.

In the end, we can approximate $\frac{1}{z-a}$ uniformly on K by polynomials in $\frac{1}{z-b}$, and as discussed $\frac{1}{z-b}$ can be approximated uniformly on K by polynomials, so we are done. \square

This proposition and the two lemmata together finishes the proof of

Theorem 28.1.4 (Runge's theorem). *Let G be a region and $K \subset G$ be compact. Let $f \in H(G)$.*

- (i) *For any $\varepsilon > 0$, there exists a rational function $R(z)$ with all poles in $G \setminus K$ such that $|f(z) - R(z)| < \varepsilon$ for all $z \in K$.*
- (ii) *Suppose $\mathbb{C} \setminus K$ is connected. Then for any $\varepsilon > 0$ there exists a polynomial $P(z)$ such that $|f(z) - P(z)| < \varepsilon$ for all $z \in K$.*

28.2 Mittag-Leffler's theorem

Weierstrass factorisation theorem, along with Theorem 20.1.9, tell us that there exist holomorphic functions with a prescribed set of zeros.

We want to answer a related question: does there exist a meromorphic function with a prescribed set of poles or, more specifically, does there exist a meromorphic function with prescribed *singular part*?⁸

The answer is the affirmative:

Theorem 28.2.1 (Mittag-Leffler's theorem). *Let G be a region and let $\{a_k\} \subset G$ be a sequence of distinct points such that $\{a_k\}$ has no limit points. For each $k \in \mathbb{N}$, let*

$$S_k(z) = \sum_{j=1}^{m_k} \frac{A_{j_k}}{(z - a_k)^j}$$

where $m_k \in \mathbb{N}$ and $A_{j_k} \in \mathbb{C}$. Then there exists $f \in M(G)$ whose poles are exactly $\{a_k\}$ and the singular part of f at $z = a_k$ is $S_k(z)$.

Proof. Note that, ideally, we simply want to sum $S_k(z)$ over k , however this sum might be divergent, so we need to be a little bit more delicate.

⁸Meaning the negative powers in the Laurent expansion.

Write

$$G = \bigcup_{n=1}^{\infty} K_n,$$

where all K_n are compact and $K_n \subset \text{int}(K_{n+1})$, so that the K_n are growing. Note how since $\{a_k\}$ has no limit points and K_n is compact, $\{a_k\} \cap K_n$ is a finite set.

Define $I_1 = \{k \mid a_k \in K_1\}$, $I_2 = \{k \mid a_k \in K_2 \setminus K_1\}$, and so on, with $I_n = \{k \mid a_k \in K_n \setminus K_{n-1}\}$ in general.

With this, define

$$f_n(z) = \sum_{k \in I_n} S_k(z).$$

By convention we take $f_n = 0$ if $I_n = \emptyset$. Then $f_n(z)$ is a rational function with poles exactly at $\{a_k \mid k \in I_n\} \subset K_n \setminus K_{n-1}$.

Since f_n has no poles in K_{n-1} , f_n is analytic on a neighbourhood of K_{n-1} , so by Runge's theorem there exists a rational function $R_n(z)$ with poles in $\mathbb{C} \setminus G$ such that

$$|f_n(z) - R_n(z)| < \frac{1}{2^n}$$

for all $z \in K_{n-1}$. (Note how originally Runge's theorem only says the poles are in $\mathbb{C} \setminus K$, but since $\mathbb{C} \setminus K$ is larger than $\mathbb{C} \setminus G$, we can push the poles further to specifically lie in $\mathbb{C} \setminus G$ by the same argument as used in the proof of Lemma 28.1.3.)

Now define

$$f(z) = f_1(z) + \sum_{n=2}^{\infty} (f_n(z) - R_n(z))$$

for $z \in G$. We claim that f is analytic on $G \setminus \{a_k\}$.

To see this, let $K \subset (G \setminus \{a_k\})$ be compact. Then $K \subset K_N$ for some sufficiently large N , whereby for $n \geq N$ we have

$$|f_n(z) - R_n(z)| < \frac{1}{2^n}$$

for all $z \in K$. Therefore

$$\sum_{n=N}^{\infty} (f_n(z) - R_n(z))$$

is uniformly convergent on K , and hence analytic on K .

Since $K \cap \{a_k\} = \emptyset$, $f_1(z), f_2(z), \dots, f_{N-1}(z)$ are analytic on K (K doesn't touch any of their poles). Hence f is analytic on K , and $K \subset (G \setminus \{a_k\})$ is arbitrary, so f is analytic on $G \setminus \{a_k\}$.

Finally, we claim that each a_k is a pole of f with singular part exactly $S_k(z)$. To show this, fix a_k . Then there exists some $R > 0$ such that $a_k \notin B(a_j, R)$ for $j \neq k$. Write, for $z \in B(a_k, R)$,

$$f(z) = S_k(z) + g(z),$$

with g analytic, since f has no other poles in $B(a_k, R)$. Then this is a Laurent expansion about $z = a_k$, which by uniqueness means that $S_k(z)$ is the singular part of f at $z = a_k$, finishing the proof. \square

Exercise 28.1. Let $\{a_n\} \subset \mathbb{C}$ be a sequence of distinct points such that $|a_n| \rightarrow \infty$ as $n \rightarrow \infty$. Let $\{b_n\} \subset \mathbb{C}$ and $\{k_n\} \subset \mathbb{Z}$. Suppose that

$$\sum_{n=1}^{\infty} \left(\frac{r}{a_n}\right)^{k_n} \frac{b_n}{a_n}$$

converges absolutely for all $r > 0$.

Show that

$$\sum_{n=1}^{\infty} \left(\frac{z}{a_n}\right)^{k_n} \frac{b_n}{z - a_n}$$

converges in $M(\mathbb{C})$ to a function f with poles at each point $z = a_n$. ■

Exercise 28.2. Find a meromorphic function f with poles of order 2 at \sqrt{n} , ($n = 1, 2, \dots$), such that the residue at each pole is 2 and

$$\lim_{z \rightarrow \sqrt{n}} (z - \sqrt{n})^2 f(z) = 1$$

for all n . ■

Lecture 29 Analytic Continuation

29.1 Analytic continuation

Definition 29.1.1 (Analytic continuation). Let $G_1 \subset G$ be regions. Let $f: G_1 \rightarrow \mathbb{C}$ be analytic. A function $g: G \rightarrow \mathbb{C}$ is an **analytic continuation** of f to G if g is analytic and $g|_{G_1} = f$.

Recall from Exercise 1.2 how if G is a region and $\bar{G} = \{z \mid \bar{z} \in G\}$, then if $f: G \rightarrow \mathbb{C}$ is analytic, so is $f^*: \bar{G} \rightarrow \mathbb{C}$ defined by $f^*(z) = \overline{f(\bar{z})}$.

Suppose, as a special case, that G and \bar{G} touch (meaning they meet, at least, somewhere on the real axis). Then $f^*(z) = \overline{f(\bar{z})} = f(z)$ on the real line. But on the real line $\bar{z} = z$, so $\overline{f(z)} = f(z)$, meaning that $f(z)$ is real on the real line.

This idea gives rise to the following:

Theorem 29.1.2 (Schwarz reflection principle). Let G be a region such that $G = \bar{G}$.⁹ Let $G_+ = \{z \in G \mid \text{Im}(z) > 0\}$, $G_0 = \{z \in G \mid \text{Im}(z) = 0\}$, and $G_- = \{z \in G \mid \text{Im}(z) < 0\}$.

Let $f: G_+ \cup G_0 \rightarrow \mathbb{C}$ be a continuous function which is analytic on G_+ . Suppose $f(z)$ is real on G_0 .

Then there exists an analytic function $g: G \rightarrow \mathbb{C}$ such that $g(z) = f(z)$ for all $z \in G_+ \cup G_0$.

Proof. The discussion above gives us an outline of the proof, in that the natural g is the correct one:

$$g(z) = \begin{cases} f(z), & \text{if } z \in G_+ \cup G_0 \\ \overline{f(\bar{z})}, & \text{if } z \in G_- \end{cases}$$

⁹Date: December 3rd, 2019.

⁹That is, G is symmetric under reflection across the real axis.

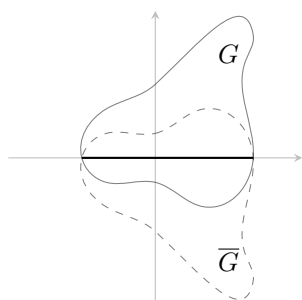

Figure 29.1.1: Two regions G and \bar{G} meeting on the real axis.

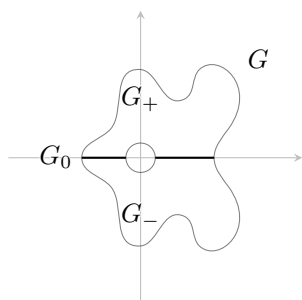

Figure 29.1.2: A schematic of G_+ , G_- , and G_0 . Note how G does not need to be simply connected.

Since f is analytic on G_+ and $\overline{f(\bar{z})}$ is analytic on $\overline{G_+} = G_-$ (by Exercise 1.2), g is continuous on those, and by hypothesis g is also continuous on G_0 . Hence g is continuous on all of G , and analytic on G_+ and G_- .

We want to show that g is analytic on G , so it remains to consider G_0 . By Morera's theorem, it suffices to show that

$$\int_T g(z) dz = 0$$

for any triangular path $T \subset G$. Now since g is analytic on G_+ and G_- , we know already that if $T \subset G_+$ or $T \subset G_-$ then the above integral is indeed zero, so we only need to consider the case when the triangle crosses the real axis.

Now importantly, analyticity is a local property, so to show that g is analytic on G , it suffices to show that it is analytic on any ball contained in G . The reason we make this distinction is that, were we not to do that, it is possible G has holes in it, and we would have to consider triangular paths around these holes. So instead consider only triangular paths T such that the region they enclose is in G .

Given any such triangle T , we partition it by cutting the triangle horizontally close to the real axis, resulting in a piece in G_+ (call it T_+), a piece in G_- (say T_-), and a piece (of small height) in both (call it T_ε), as illustrated in Figure 29.1.3. (Note how, strictly speaking there is another case to consider, namely where one or more of the vertices are on the real axis—these can be done similarly as to what follows.)

Then

$$\int_T g(z) dz = \int_{T_+} g(z) dz + \int_{T_-} g(z) dz + \int_{T_\varepsilon} g(z) dz = \int_{T_\varepsilon} g(z) dz.$$

Since g is continuous on G it is uniformly continuous on compact subsets of G , and so in particular it is uniformly continuous on the closure of the region enclosed by T , call it R . So given any $\varepsilon > 0$ there exists some $\delta > 0$ such that for any $z_1, z_2 \in R$, if $|z_1 - z_2| < \delta$ we have $|g(z_1) - g(z_2)| < \varepsilon$.

Now let us specify where we cut the triangle T to get T_ε . In particular, let $a, \alpha, \beta, b \in \{T\}$ be the corners of T_ε such that $|\alpha - a| < \frac{\delta}{2}$ and $|\beta - b| < \frac{\delta}{2}$.

Parametrising the two horizontal lines, call them γ_1 and γ_2 , we have for $0 \leq t \leq 1$

$$|(t\beta + (1-t)\alpha) - (tb + (1-t)a)| \leq t|\beta - b| + (1-t)|\alpha - a| < \frac{\delta}{2}.$$

Then

$$\begin{aligned} \left| \int_{\gamma_1} g(z) dz + \int_{\gamma_2} g(z) dz \right| &= \\ &= \left| \int_0^1 g(t\beta + (1-t)\alpha)(\beta - \alpha) dt - \int_0^1 g(tb + (1-t)a)(b - a) dt \right|, \end{aligned}$$

where we subtract the second integral because we parametrised γ_2 in the opposite direction we wish to integrate it. We bound this by

$$\begin{aligned} \left| \int_{\gamma_1} g(z) dz + \int_{\gamma_2} g(z) dz \right| &\leq |\beta - \alpha| \int_0^1 |g(t\beta + (1-t)\alpha) - g(tb + (1-t)a)| dt + \\ &\int_0^1 |g(tb + (1-t)a)((\beta - \alpha) - (b - a))| dt. \end{aligned}$$

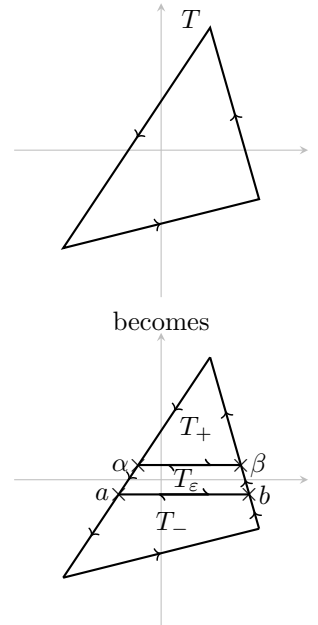

Figure 29.1.3: Partitioning a triangular path crossing the real axis.

The integrand of the first integral is bounded by ε by our uniform continuity, and we can get rid of the constant at the end of the second integral since

$$|(\beta - \alpha) - (b - a)| = |(\beta - b) - (a - \alpha)| \leq \frac{\delta}{2} + \frac{\delta}{2} = \delta.$$

Finally let

$$M = \max_{z \in T} |g(z)|$$

so that we can bound away the integrand in the second integral, finally yielding

$$\left| \int_{\gamma_1} g(z) dz + \int_{\gamma_2} g(z) dz \right| \leq |\beta - \alpha| \cdot \varepsilon + \delta \cdot M.$$

This goes to 0 as $\varepsilon \rightarrow 0$, taking $\delta \rightarrow 0$ at the same time.

This takes care of the integral over γ_1 and γ_2 , leaving the other two parts of T_ε . This is easier:

$$\left| \int_{[\alpha, a]} g(z) dz + \int_{[b, \beta]} g(z) dz \right| \leq |\alpha - a| \cdot M + |b - \beta| \cdot M \leq \delta M,$$

which also goes to 0 as $\delta \rightarrow 0$.

Hence the integral over any triangular path is 0, so by Morera's theorem g is analytic. \square

29.2 Dirichlet series

Definition 29.2.1 (Dirichlet series). A series of the form

$$D(s) = \sum_{n=1}^{\infty} \frac{a_n}{n^s}$$

with $s \in \mathbb{C}$ and $\{a_n\} \subset \mathbb{C}$ is called a *Dirichlet series*.

Example 29.2.2. The prototypical example of a Dirichlet series is the *Riemann zeta function*

$$\zeta(s) = \sum_{n=1}^{\infty} \frac{1}{n^s}.$$

▲

An important, and natural, question to ask about these series is this: for what $s \in \mathbb{C}$ do they converge, and converge in what sense? For instance, $\zeta(s)$ converges absolutely for $\operatorname{Re}(s) > 1$.

Proposition 29.2.3. *Suppose*

$$D(s) = \sum_{n=1}^{\infty} \frac{a_n}{n^s}$$

converges absolutely at $s_0 = \sigma_0 + it_0$. Then $D(s)$ converges absolutely and uniformly on $\operatorname{Re}(s) \geq \sigma_0$.

Proof. This is a straight-forward computation. For $\operatorname{Re}(s) \geq \sigma_0$ we have

$$\sum_{n=1}^{\infty} \left| \frac{a_n}{n^s} \right| = \sum_{n=1}^{\infty} \frac{|a_n|}{n^{\operatorname{Re}(s)}} \leq \sum_{n=1}^{\infty} \frac{|a_n|}{n^{\sigma_0}} < \infty.$$

Since the convergence of this last sum does not depend on s , the convergence is uniform. \square

Remark 29.2.4. (i) Because of this proposition, the region of absolute convergence of a Dirichlet series is always a half-plane.

(ii) There exists a unique $\sigma_{ac} \in [-\infty, \infty]$ such that $D(s)$ is absolutely convergent for $\operatorname{Re}(s) > \sigma_{ac}$ and is not absolutely convergent for $\operatorname{Re}(s) < \sigma_{ac}$. Such a σ_{ac} is called the **abscissa of absolute convergence** of $D(s)$.

This means the series converges absolutely to the right of the vertical line $\operatorname{Re}(s) = \sigma_{ac}$, and does not converge absolutely to the left of the line. What happens on the line is a mystery, and the behaviour of a given Dirichlet series can vary for points on this line.

If we only know about convergence, not absolute convergence, at a point, we need much more delicate calculations:

Proposition 29.2.5. *Suppose*

$$D(s) = \sum_{n=1}^{\infty} \frac{a_n}{n^s}$$

converges (not necessarily absolutely) at $s_0 = \sigma_0 + it_0$. Then $D(s)$ converges uniformly for $|\arg(s - s_0)| \leq \frac{1}{2}\pi - \delta$ where $0 < \delta < \frac{1}{2}\pi$. Hence $D(s)$ converges uniformly on any compact subset $K \subset \{s \mid \operatorname{Re}(s) > \sigma_0\}$.

Proof. Without loss of generality we may assume $s_0 = 0$ (else shift). Then

$$D(0) = \sum_{n=1}^{\infty} a_n$$

converges. Let

$$r_n = \sum_{k=n+1}^{\infty} a_k$$

be the tail of this sum. Since $D(0)$ converges, this means $r_n \rightarrow 0$ as $n \rightarrow \infty$.

For $N > M$, consider the partial sum

$$\sum_{n=M}^N \frac{a_n}{n^s} = \sum_{n=M}^N \frac{r_{n-1} - r_n}{n^s}.$$

By partial summation (really just the discrete version of integration by parts, see e.g., [Apo10, Chapter 3]) this is equal to

$$(29.2.1) \quad \sum_{n=M}^N r_n \left(\frac{1}{(n+1)^s} - \frac{1}{n^s} \right) + \frac{r_{M-1}}{M^s} - \frac{r_N}{(N+1)^s}.$$

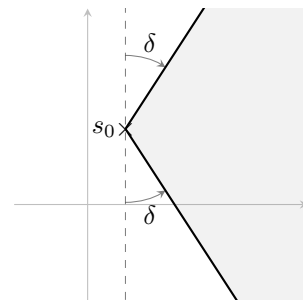

Figure 29.2.1: The sector in the setup.

Note how

$$\begin{aligned} \left| \frac{1}{(n+1)^s} - \frac{1}{n^s} \right| &= \left| s \int_n^{n+1} \frac{1}{u^{s+1}} du \right| \\ &\leq |s| \int_n^{n+1} \frac{1}{u^{\sigma+1}} du = \frac{|s|}{\sigma} \left(\frac{1}{n^\sigma} - \frac{1}{(n+1)^\sigma} \right), \end{aligned}$$

where $\operatorname{Re}(s) = \sigma$.

Since $r_n \rightarrow 0$, for any $\varepsilon > 0$ there exists some $N_0 \in \mathbb{N}$ such that for $n > N_0$, $|r_n| < \varepsilon$, and so for $s = \sigma + it$ with $\sigma > 0$ and $N > M > N_0$, we have, looking back at Equation (29.2.1),

$$\left| \sum_{n=M}^N \frac{a_n}{n^s} \right| \leq \frac{|s|\varepsilon}{\sigma} \sum_{n=M}^N \left| \frac{1}{n^\sigma} - \frac{1}{(n+1)^\sigma} \right| + \frac{\varepsilon}{M^\sigma} + \frac{\varepsilon}{(N+1)^\sigma}.$$

In the sum on the right-hand side we can replace the absolute values with parentheses, since the $\frac{1}{n^\sigma} \geq \frac{1}{(n+1)^\sigma}$ are real, and so we get a telescoping sum, meaning that

$$\left| \sum_{n=M}^N \frac{a_n}{n^s} \right| \leq \frac{\varepsilon|s|}{\sigma} \left(\frac{1}{M^\sigma} - \frac{1}{(N+1)^\sigma} \right) + 2\varepsilon \leq 2\varepsilon \frac{|s|}{\sigma} + 2\varepsilon$$

by bounding the fractions by 1.

It remains to study $\frac{|s|}{\sigma}$. With a bit of trigonometry (as laid out in Figure 29.2.2), if $|\arg(s)| \leq \frac{1}{2}\pi - \delta$, then $\frac{t}{\sigma} \leq \tan(\frac{1}{2}\pi - \delta)$, so

$$\frac{|s|}{\sigma} = \frac{\sqrt{\sigma^2 + t^2}}{\sigma} = \sqrt{1 + \left(\frac{t}{\sigma}\right)^2} \leq \sqrt{1 + \tan^2\left(\frac{1}{2}\pi - \delta\right)}.$$

This bounds $\frac{|s|}{\sigma}$ uniformly in the sector, so letting $\varepsilon \rightarrow 0$, this means

$$\left| \sum_{n=M}^N \frac{a_n}{n^s} \right|$$

goes to 0 uniformly in $N > M$, giving us the convergence we are after.

That this implies uniform convergence on compact subsets is simply a consequence of any compact subset being contained in some sector of this form. \square

Lecture 30 Perron's Formula

30.1 Uniqueness of Dirichlet series

Remark 30.1.1. As a consequence of Proposition 29.2.5, we infer:

- (i) The region of convergence of a Dirichlet series is a half-plane.
- (ii) There exists a unique $\sigma_c \in [-\infty, \infty]$ such that $D(s)$ converges for $\operatorname{Re}(s) > \sigma_c$ and diverges for $\operatorname{Re}(s) < \sigma_c$. Such a σ_c is called the **abscissa of convergence** of $D(s)$.

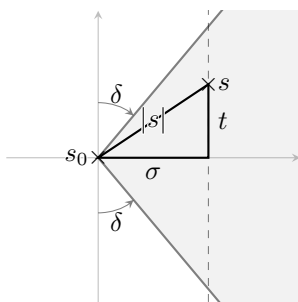

Figure 29.2.2: The trigonometry of $\frac{|s|}{\sigma}$.

Notice how, since absolute convergence implies convergence, $\sigma_c \leq \sigma_{ac}$. However they need not be equal.

Example 30.1.2. Consider the alternating harmonic series

$$D(s) = \sum_{n=1}^{\infty} \frac{(-1)^n}{n^2}.$$

This has abscissa of absolute convergence $\sigma_{ac} = 1$, but abscissa of convergence $\sigma_c = 0$ (from **Dirichlet's test**: $a_n = (-1)^n$ has bounded average, and $\frac{1}{n^s}$ is decreasing to 0 in magnitude for $\operatorname{Re}(s) > 0$). \blacktriangle

In this example σ_{ac} and σ_c differ by one. This is the worst case scenario:

Proposition 30.1.3. *Let*

$$D(s) = \sum_{n=1}^{\infty} \frac{a_n}{n^s}$$

with abscissa of absolute convergence σ_{ac} and abscissa of convergence σ_c . Then $0 \leq \sigma_{ac} - \sigma_c \leq 1$.

Proof. The left-hand side inequality is trivial since $\sigma_c \leq \sigma_{ac}$. Hence it remains to show $\sigma_{ac} \leq 1 + \sigma_c$, i.e., show that

$$\sum_{n=1}^{\infty} \frac{a_n}{n^{1+\sigma_c+\varepsilon}}$$

converges absolutely for all $\varepsilon > 0$.

Since σ_c is the abscissa of convergence,

$$D\left(\sigma_c + \frac{\varepsilon}{2}\right) = \sum_{n=1}^{\infty} \frac{a_n}{n^{\sigma_c + \frac{\varepsilon}{2}}}$$

converges, meaning that the individual terms must go to zero. In other words,

$$\lim_{n \rightarrow \infty} \frac{a_n}{n^{\sigma_c + \frac{\varepsilon}{2}}} = 0.$$

Hence there exists some $N \in \mathbb{N}$ such that for $n > N$,

$$\left| \frac{a_n}{n^{\sigma_c + \frac{\varepsilon}{2}}} \right| < 1.$$

Consequently we consider the tail

$$\sum_{n=N}^{\infty} \left| \frac{a_n}{n^{1+\sigma_c+\varepsilon}} \right| = \sum_{n=N}^{\infty} \left| \frac{a_n}{n^{\sigma_c + \frac{\varepsilon}{2}}} \right| \cdot \frac{1}{n^{1+\frac{\varepsilon}{2}}} \leq \sum_{n=N}^{\infty} \frac{1}{n^{1+\frac{\varepsilon}{2}}} < \infty,$$

so we have the absolute convergence we were looking for. \square

Theorem 30.1.4 (Uniqueness theorem for Dirichlet series). *Let*

$$D(s) = \sum_{n=1}^{\infty} \frac{a_n}{n^s} \quad \text{and} \quad F(s) = \sum_{n=1}^{\infty} \frac{b_n}{n^s}$$

with abscissae of absolute convergence less than σ . Suppose there exist $\{s_k\} \subset \{s \mid \operatorname{Re}(s) > \sigma\}$ such that

(i) $\operatorname{Re}(s_k) = \sigma_k \rightarrow \infty$ as $k \rightarrow \infty$ and

(ii) $D(s_k) = F(s_k)$ for all k .

Then $a_n = b_n$ for all $n \in \mathbb{N}$.

Proof. Define a new Dirichlet series

$$G(s) = D(s) - F(s) = \sum_{n=1}^{\infty} \frac{a_n - b_n}{n^s} = \sum_{n=1}^{\infty} \frac{c_n}{n^s},$$

i.e., let $c_n = a_n - b_n$. We wish to show that $c_n = 0$ for all $n \in \mathbb{N}$.

Notice how, by assumption, $G(s_k) = 0$ for all k . Now suppose $c_n \neq 0$ for some n . Then there must be a smallest index for which c_n is nonzero, so let N be the smallest integer such that $c_N \neq 0$, meaning that $c_n = 0$ for all $n < N$. Then

$$G(s) = \sum_{n=N}^{\infty} \frac{c_n}{n^s} = \frac{c_N}{N^s} + \sum_{n=N+1}^{\infty} \frac{c_n}{n^s}.$$

Since $G(s_k) = 0$, we must have

$$\frac{c_N}{N^{\sigma_k}} + \sum_{n=N+1}^{\infty} \frac{c_n}{n^{\sigma_k}} = 0,$$

which, if we rearrange and take absolute values, becomes

$$|c_N| \leq N^{\sigma_k} \sum_{n=N+1}^{\infty} \frac{|c_n|}{n^{\sigma_k}} \leq \frac{N^{\sigma_k}}{(N+1)^{\sigma_k - \sigma - \varepsilon}} \sum_{n=N+1}^{\infty} \frac{abc_n}{n^{\sigma + \varepsilon}}.$$

The factor in front of the summation goes to 0 as $\sigma_k \rightarrow \infty$, and the sum is finite since we are in the region of absolute convergence. Hence all of this goes to 0, implying that $c_N = 0$, which is a contradiction. \square

30.2 Perron's formula

Lemma 30.2.1. *Let $c > 0$ and $y > 0$. Then we have*

$$\frac{1}{2\pi i} \int_{(c)} y^w \frac{dw}{w} = \begin{cases} 1, & \text{if } y > 1 \\ 0, & \text{if } 0 < y < 1. \end{cases}$$

Remark 30.2.2. By integrating over (c) we mean to integrate along the vertical line at $\operatorname{Re}(s) = c$, i.e., in this example,

$$\frac{1}{2\pi i} \int_{(c)} y^w \frac{dw}{w} = \frac{1}{2\pi i} \int_{c-i\infty}^{c+i\infty} y^w \frac{dw}{w}.$$

Proof. Let us consider $y > 1$ first. The integrand $\frac{y^w}{w}$ is analytic except for a simple pole at $w = 0$ with residue 1, so integrating over the semicircle described in Figure 30.2.1 by Cauchy's integral formula

$$1 = \frac{1}{2\pi i} \int_{\gamma_R} y^w \frac{dw}{w} + \frac{1}{2\pi i} \int_{c-iR}^{c+iR} y^w \frac{dw}{w}.$$

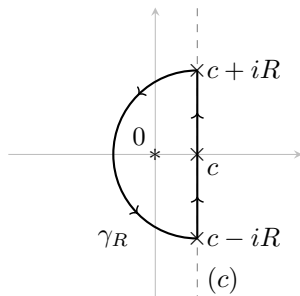

Figure 30.2.1: The choice of contour when $y > 1$.

Sending $R \rightarrow \infty$ the second integral becomes the integral we want, so ideally the first integral goes to 0 as $R \rightarrow \infty$.

So for $w \in \{\gamma_R\}$ we parametrise as $w = c + Re^{i\theta}$, with $\frac{\pi}{2} \leq \theta \leq \frac{3\pi}{2}$. Here also $dw = Ri e^{i\theta} d\theta$, and we estimate $|w| = |c + Re^{i\theta}| \geq R - c$ (since c is fixed and R is large). Then

$$\left| \frac{1}{2\pi i} \int_{\gamma_R} y^w \frac{dw}{w} \right| \leq \frac{1}{2\pi} \int_{\pi/2}^{3\pi/2} y^c y^{R \cos(\theta)} \frac{R d\theta}{R - c}.$$

Since $\frac{\pi}{2} \leq \theta \leq \frac{3\pi}{2}$, $\cos(\theta) < 0$, and so $R \cos(\theta)$ is negative meaning that, since $y > 1$, $y^{R \cos(\theta)} \rightarrow 0$ as $R \rightarrow \infty$. Consequently the entire integral goes to 0 since $\frac{R}{R-c} \rightarrow 1$ as $R \rightarrow \infty$.

Next we consider the case $0 < y < 1$. The estimate is similar, only this time we want to integrate over a semicircle extending to the right (see Figure 30.2.2), since for $0 < y < 1$ we want positive powers to make the integrand small.

Again there is a simple pole of $\frac{y^w}{w}$ at $w = 0$, but this lies outside of our contour, so by Cauchy's integral formula

$$0 = \frac{1}{2\pi i} \int_{\gamma_R} y^w \frac{dw}{w} + \frac{1}{2\pi i} \int_{c-iR}^{c+iR} y^w \frac{dw}{w}.$$

As before, the second integral goes to the integral we want when $R \rightarrow \infty$, and we show that the first integral goes to 0.

Indeed, with the same parametrisation, only with $-\frac{\pi}{2} \leq \theta \leq \frac{\pi}{2}$, we get

$$\left| \frac{1}{2\pi i} \int_{\gamma_R} y^w \frac{dw}{w} \right| \leq \frac{1}{2\pi} \int_{-\pi/2}^{\pi/2} y^c y^{R \cos(\theta)} \frac{R d\theta}{R - c}.$$

Since $\cos(\theta) > 0$ in this range, the exponent is positive, but $0 < y < 1$ so $y^{R \cos(\theta)} \rightarrow 0$ as $R \rightarrow \infty$. Hence the integral goes to 0 as $R \rightarrow \infty$, again. \square

In order to prove Perron's formula we need the following technical lemma, the proof of which is not difficult, but is a bit lengthy:

Lemma 30.2.3. *Let*

$$D(s) = \sum_{n=1}^{\infty} \frac{a_n}{n^s}$$

with abscissa of convergence σ_c . For $s = \sigma + it$, $\sigma_c < \sigma < \sigma_c + 1$, we have

$$D(s) \ll |t|^{1-(\sigma-\sigma_c)+\varepsilon}$$

for any $\varepsilon > 0$.

The idea of the proof is similar to that of Proposition 29.2.5.

Theorem 30.2.4 (Perron's formula). *Let*

$$D(s) = \sum_{n=1}^{\infty} \frac{a_n}{n^s}$$

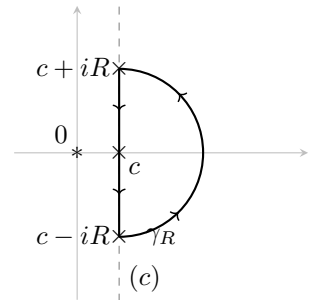

Figure 30.2.2: The choice of contour when $0 < y < 1$.

with abscissa of convergence σ_c . Let $X > 0$, $X \notin \mathbb{N}$, and $c > 0$. For any $s = \sigma + it$ with $\sigma + c > \sigma_c$, we have

$$\sum_{n < X} \frac{a_n}{n^s} = \frac{1}{2\pi i} \int_{(c)} D(s+w) X^w \frac{dw}{w}.$$

In particular,

$$\sum_{n < X} a_n = \frac{1}{2\pi i} \int_{(c)} D(w) X^w \frac{dw}{w}$$

for $c > \sigma_c$.

This is a remarkable formula: it translates a discrete average into an analytic formula. Hence by understanding analytic properties of the Dirichlet series, we can glean understanding about the sequence $\{a_n\}$.

Sketch of proof. The main idea of the proof is to write $D(s+w)$ in the right-hand side in terms of its series representation, then switch the order of summation and integration, like so:

$$\begin{aligned} \frac{1}{2\pi i} \int_{(c)} D(s+w) X^w \frac{dw}{w} &= \frac{1}{2\pi i} \int_{(c)} \left(\sum_{n=1}^{\infty} \frac{a_n}{n^{s+w}} \right) X^w \frac{dw}{w} \\ &= \sum_{n=1}^{\infty} \frac{a_n}{n^s} \frac{1}{2\pi i} \int_{(c)} \left(\frac{X}{n} \right)^w \frac{dw}{w}. \end{aligned}$$

There are two steps of note here: first, we can write $D(s+w)$ in terms of its series representation since $\operatorname{Re}(s+w) = \sigma + c > \sigma_c$, so we are in the region of convergence. Second, being able to switch the order of summation and integration is not trivial. In this case we can do this because we have control of the size of the tails courtesy of Lemma 30.2.3.

With those details out of the way, we are done: the resulting integral at the end can be evaluated using Lemma 30.2.1:

$$\frac{1}{2\pi i} \int_{(c)} \left(\frac{X}{n} \right)^w \frac{dw}{w} = \begin{cases} 1, & \text{if } X > n \\ 0, & \text{if } X < n. \end{cases}$$

Hence this truncates the series to

$$\frac{1}{2\pi i} \int_{(c)} D(s+w) X^w \frac{dw}{w} = \sum_{n < X} \frac{a_n}{n^s}$$

as desired. □

Remark 30.2.5. Note that both Lemma 30.2.1 and Perron's formula can be worked out in the case where $y = 1$ (or correspondingly $X \in \mathbb{N}$). In this case the integral in Lemma 30.2.1 evaluates to $\frac{1}{2}$ (from plain calculation, no tricky integration required), and consequently the resulting sum in Perron's formula would add only half of the final term if $X \in \mathbb{N}$.

All by way of saying: requiring $X \notin \mathbb{N}$ simply makes the formula slightly cleaner looking; it isn't a technical limitation.

References

- [AG37] Lars V. Ahlfors and Helmut Grunsky. Über die blochsche konstante. *Mathematische Zeitschrift*, 42(1):671–673, 1937. 95
- [Apo10] Tom M. Apostol. *Introduction to Analytic Number Theory*. Undergraduate Texts in Mathematics. Springer Verlag, New York, 2010. 113
- [CG96] Huaihui Chen and Paul M. Gauthier. On bloch’s constant. *Journal d’Analyse Mathématique*, 69(1):275–291, 1996. 95
- [Con78] John B. Conway. *Functions of One Complex Variable*, volume 11 of *Graduate Texts in Mathematics*. Springer Verlag, New York, 2nd edition, 1978. i
- [Xio98] Chengji Xiong. Lower bound of bloch’s constant. *Nanjing Daxue Xuebao Shuxue Bannian Kan*, 15(2):174–179, 1998. 95

Index

A

abscissa of absolute convergence 113
 abscissa of convergence114
 absolute convergence 71
 absolute value 1
 analytic continuation110
 analytic function 2
 argument principle36–37
 Arzelà–Ascoli theorem 54
 automorphism 40

B

Blaschke product 79
 Bloch’s constant 95
 Bloch’s theorem 92
 Borel–Carathéodory’s inequality 41

C

Casorati–Weierstrass theorem .. 32
 Cauchy’s integral formula 20
 Cauchy’s residue theorem 33
 Cauchy’s theorem 11, 20
 Cauchy–Riemann equations 4
 Cayley transform 42
 compactification 58
 complex conjugate 1
 complex differentiability 2
 conformal equivalence 64
 conformal mapping 5
 continuous functions 51
 cross ratio 9

D

Dirichlet series112
 uniqueness theorem .. 115–116
 Dirichlet’s test 115

E

entire function 14
 equicontinuity 54
 exponent of convergence 89

F

Fundamental theorem of algebra 15

G

genus 82
 finite 82
 Goursat’s theorem 24

Great Picard theorem 102

H

Haar measure 43
 Hadamard three-circle theorem .46
 Hadamard three-lines theorem 43–
 44
 Hadamard’s factorisation theorem
 87
 Hardy’s theorem 46–47
 harmonic
 conjugate 4
 function 4
 holomorphic functions 52
 homotopic 21
 Hurwitz’s theorem 53
 hyperbolic measure 43

I

imaginary part 1
 infinite product 69

J

Jensen’s formula 80

L

Landau’s constant 95
 Laplace operator 4
 Laurent expansion 29
 Lebesgue’s number lemma 37
 Lie group 43
 linear fractional transformation *see*
 Möbius transformation
 Liouville’s theorem 15
 Little Picard theorem 98
 locally bounded 55
 logarithmic derivative 22

M

maximum modulus principle ... 18,
 38–39
 mean value property 13
 meromorphic function 35, 58
 metric space 54
 Mittag-Leffler’s theorem 108
 modulus *see* absolute value
 Montel’s theorem 55
 Montel–Carathéodory theorem 102
 Morera’s theorem 20–21
 Möbius transformation 6

N

normal 54

O

open mapping theorem 24

order 85

finite 85

infinite 85

P

Perron's formula 117–118

Phragmén–Lindelöf principle ... 47

Picard's theorem

 great *see* Great Picard
 theorem little *see* Little Picard theorem

special case 89

polar form 1

pole 28

order of 28

power series 12

preserve angle 5

R

rank 82

finite 82

infinite 82

real part 1

rectifiable 14

region 16

residue 33

Riemann mapping theorem 64

Riemann sphere 7, 56

Riemann zeta function ... 88, 112

Rouché's theorem 37

Runge's theorem 105, 108

S

Schottky's theorem 99

Schwarz lemma 39

Schwarz reflection principle ... 110

Schwarz–Pick theorem 41

simply connected 21

singular part 108

singularity

essential 28

isolated 26

removable 26

special linear group 7

projective 7

standard form 82

T

triangular path 20

U

upper half-plane 42

V

Vinogradov notation 83

WWeierstrass factorisation theorem
77

Weierstrass theorem 104

winding number 19

Z

zero set 16