

HIGH-HEAT-FLUX REMOVAL BY PHASE-CHANGE FLUID AND PARTICULATE FLOW

ZINOVY R. GORBIS, A. RENÉ RAFFRAY, and MOHAMED A. ABDU University of California-Los Angeles Mechanical, Aerospace, and Nuclear Engineering Department Los Angeles, California 90024-1597

Received July 20, 1992

Accepted for Publication December 9, 1992

A new concept based on particulate flow in which either or both the particulates and the fluid could undergo phase changes is proposed. The presence of particulates provides not only a mechanism for additional heat removal through phase change but also the potential for increasing the rate of heat transfer by enhancing convection through surface region/bulk "mixing"; by enhancing radiation, particularly for high-temperature cases; and for the case of multiphase fluid, by enhancing the boiling process. One particularly interesting coolant system based on this concept is "subcooled boiling water-ice particulate" flow. A preliminary analysis of this coolant system is presented, the results of which indicate that such a coolant system is better applied for cooling of relatively small surface areas with high local heat fluxes, where a conventional cooling system would come short of providing the required heat removal at acceptable coolant pressure levels.

INTRODUCTION

Plasma-facing components in a fusion reactor are under very high heat loads. During the conceptual design activity (CDA) phase of the International Thermonuclear Experimental Reactor (ITER) study, divertor heat loads of up to 30 MW/m² were estimated for normal operation.^{1,2} Disruption conditions would increase the heat load to hundreds of megawatts per square metre over a short time. These heat load levels led to the consideration of special-purpose coolant systems, such as subcooled water in a channel with increased mass velocity and twisted tapes, helium flow with internal microfins, and liquid-metal film flow.¹⁻⁷

In this spirit, phase-change fluid and particulate flow (PCFPF) is proposed as a coolant system that could significantly enhance the heat removal capability. The coolant consists of a mix of single-phase or boiling fluid and phase-changing particulates. The particulates can be solid and undergo melting and even vaporization, or they can be liquid and undergo vaporization. The presence of particulates provides not only a mechanism for additional heat removal through phase change but also the potential for increasing the

DIVERTOR SYSTEMS

TECHNICAL NOTE

KEYWORDS: *high heat flux, divertor cooling system, particulate flow*

rate of heat transfer by enhancing convection through surface region/bulk "mixing"; by enhancing radiation, particularly for high-temperature particulates and gas; and for the case of multiphase fluid, by enhancing the boiling process. For example, past experimental results indicate that heat transfer can be increased substantially when boiling occurs in the presence of nonmelting particulates. References 8 and 9 describe experimental studies of such a system, referred to as a thermal fluidization system, and they show that heat transfer can be increased by a factor of 2 to 3 and that liquid vaporization would start for a much smaller film temperature drop than in the case of liquid boiling in the absence of particulates. The resulting effect on the critical heat flux (CHF), however, tends to be small and depends on the particle size and characteristics.

One particularly interesting coolant system based on this concept is "subcooled boiling water-ice particulate" flow. In this case, the mixing mechanism could enhance the heat transfer process through particulate/bubble/wall interactions inducing additional wall surface wetting and recirculation in the wall region, which could result in both a higher heat transfer coefficient and a higher CHF limit.

This technical note summarizes the preliminary analysis performed on this type of PCFPF coolant. As an initial step, the study focuses on only one of the previously mentioned heat transfer enhancement mechanisms, namely, the effect of the latent heat of fusion of the ice particulates as they melt. The calculations should then yield a conservative estimate of the heat removal capacity. The corresponding pressure drop and refrigeration power requirements are also estimated, in light of which an assessment is made of the parameter space over which this cooling mechanism would best apply.

EFFECT OF ICE PARTICULATES ON CHF

Including ice particulates in the water coolant could increase the CHF in a number of ways, including the following:

1. increasing the inlet subcooling to its maximum value as the inlet temperature is at the ice melting point, thus maximizing the subcooling temperature rise
2. allowing for higher heat fluxes through ice melting to an extent dependent on the latent heat of fusion of ice and on the ice particulate mass flow fraction

3. enhancing the mixing process between the coolant bulk and the wall region through ice particulate motion and interaction with wall surface and bubbles, and, hence, potentially increasing the heat transfer. The extent to which this phenomenon would increase the CHF needs to be determined through detailed analytical and experimental studies.

For the calculations presented here, only the first two effects are considered, the first one by maximizing the subcooling term in the equation for the CHF and the second one by assuming, as an upper bound, that all the ice would melt. The heat flux accommodated by the melting ice q''_{ice} is given by (see Nomenclature on p. 441)

$$q''_{ice} = F_{ice} \frac{Gh_{ice}D}{4z} \quad (1)$$

where

F_{ice} = mass fraction of ice in the flow

G = coolant mass velocity

h_{ice} = latent heat of fusion of the ice

D = tube diameter

z = tube length.

The CHF for water flow is dependent on a number of parameters, such as inlet subcooling, pressure P , mass velocity, and, in some cases, tube length and diameter.^{10,11} Other factors, such as use of noncircular tubes and nonuniform circumferential or axial heat flux profiles, can also substantially affect the CHF value.¹¹ For simplicity, our initial calculations assume vertical, uniformly heated, round tubes. Even for this case, a number of correlations exist for estimating the CHF based on various hypotheses and different sets of experimental data. The Russian Academy of Sciences¹² produced a series of standard tables for the CHF as a function of the local bulk mean water condition for various pressures and mass velocities for a fixed tube diameter. These tables are valid for $z/D > 20$, where the CHF is assumed to be independent of the tube length but inversely proportional to the square root of the tube diameter.

Barnett and Macbeth developed a correlation based on the hypothesis that the CHF is solely a function of mass quality at the point of overheating and based on the simplifying assumption that the CHF is a linear function of inlet subcooling.¹¹ The CHF based on their expression is given by

$$q''_{cr}(B) = \frac{A + 0.25DGC_{pf}\Delta T_{sub}}{B + z} \quad (2)$$

Bowring correlated functions A and B as follows¹¹:

$$A = \frac{2.317F_1 \frac{Dgh_{fg}}{4}}{1.0 + 0.0143F_2D^{0.5}G} \quad (3)$$

and

$$B = \frac{0.077F_3DG}{1.0 + 0.347F_4(G/1356)^n} \quad (4)$$

where

$$n = 2.0 - 0.00725P \quad (5)$$

D = tube diameter (m)

C_{pf} = specific heat of water (J/kg·K)

ΔT_{sub} = subcooling temperature rise from inlet condition to saturation (K)

G = mass velocity (kg/m²·s)

z = tube length (m)

h_{fg} = latent heat of vaporization of water (J/kg)

P = inlet pressure (bar).

The terms F_1 , F_2 , F_3 , and F_4 are functions of system pressure and are given in tabular form.

The correlation was derived from data covering the following parameter ranges (and, thus, is best applied for the same parameter ranges): pressure = 2 to 190 bar; tube diameter = 0.002 to 0.045 m; tube length = 0.15 to 3.7 m; and mass velocity = 136 to 18 600 kg/m²·s.

The CHF was estimated based on Eq. (2) for four different tube size combinations:

1. $z = 1$ m, $D = 0.01$ m

2. $z = 1$ m, $D = 0.02$ m

3. $z = 0.15$ m, $D = 0.01$ m

4. $z = 0.15$ m, $D = 0.02$ m.

These combinations were chosen as reasonably representative of divertor cooling tube cases. Figures 1 through 4 show the CHF as a function of G for these four cases for two system inlet pressures:

2 bar

$$\Delta T_{sub} = 120 \text{ K}, \quad h_{fg} = 2202 \text{ kJ/kg},$$

$$C_{pf} = 4.25 \text{ kJ/kg} \cdot \text{K},$$

$$F_1 = 0.478, \quad F_2 = 1.591, \quad F_3 = 0.400, \quad F_4 = 0.00163$$

and

30 bar

$$\Delta T_{sub} = 234 \text{ K}, \quad h_{fg} = 1795 \text{ kJ/kg},$$

$$C_{pf} = 4.50 \text{ kJ/kg} \cdot \text{K},$$

$$F_1 = 0.488, \quad F_2 = 0.390, \quad F_3 = 0.405, \quad F_4 = 0.1029$$

The figures also show the heat flux required for complete ice melting based on Eq. (1) for $F_{ice} = 0.4$. The maximum heat flux that could be accommodated in the presence of ice particulates would be equivalent to the summation of the CHF calculated from Eq. (2) and of q''_{ice} . However, this would give an upper bound of the enhancement of CHF, whose extent would depend not only on the amount of melted ice but also on whether the local heat transfer process at the wall can accommodate the extra heat flux required to melt the ice while maintaining an acceptable wall temperature level. Moreover, a coolant system is typically designed with a safety factor, $C > 1$, such that the maximum heat flux removal requirement of the system is given by CHF/ C . In this case, it could be argued that an extra heat flux of up to $(1 - 1/C)$ CHF could be accommodated by the melting ice, and even more if the local heat transfer mechanisms allow it. Again, more detailed analytical and experimental studies are required to address the extent to which the presence of ice particulates can enhance the intensity of heat transfer and the CHF. However, some general observations can be made from Figs. 1 through 4:

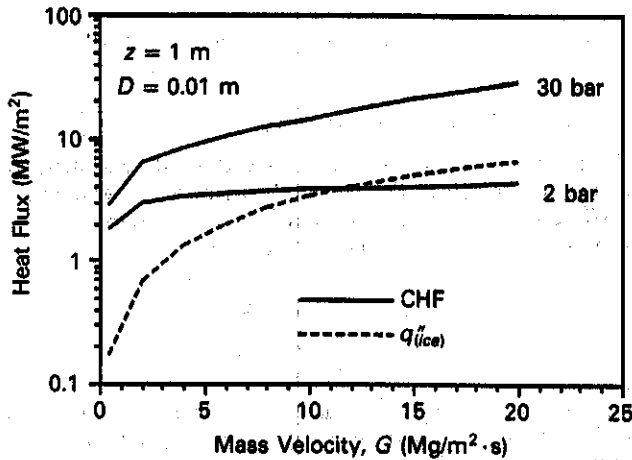

Fig. 1. The CHF based on the Bowring correlation as a function of mass velocity for $z = 1$ m, $D = 0.01$ m, and inlet pressures of 2 and 30 bar. The heat flux required to melt a 40% mass fraction of ice in the flow is also shown.

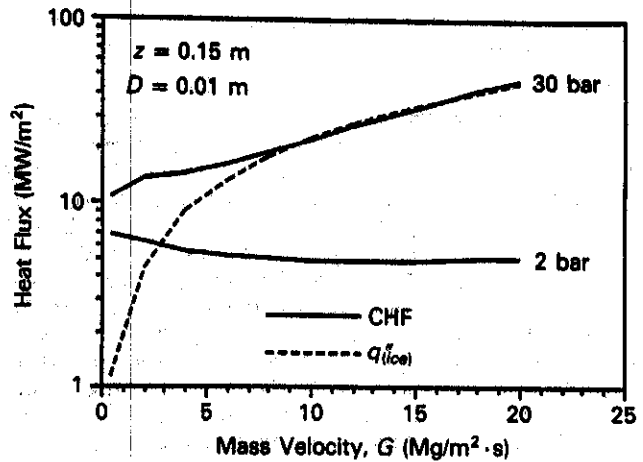

Fig. 3. The CHF based on the Bowring correlation as a function of mass velocity for $z = 0.15$ m, $D = 0.01$ m, and inlet pressures of 2 and 30 bar. The heat flux required to melt a 40% mass fraction of ice in the flow is also shown.

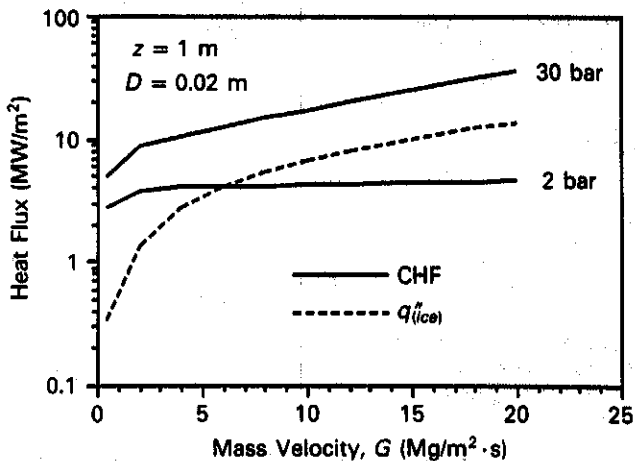

Fig. 2. The CHF based on the Bowring correlation as a function of mass velocity for $z = 1$ m, $D = 0.02$ m, and inlet pressures of 2 and 30 bar. The heat flux required to melt a 40% mass fraction of ice in the flow is also shown.

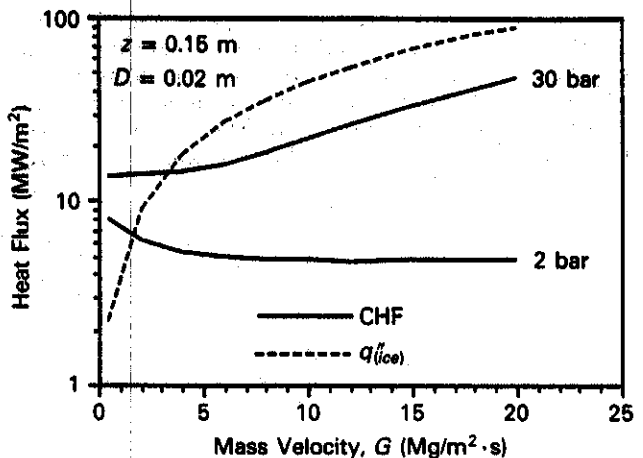

Fig. 4. The CHF based on the Bowring correlation as a function of mass velocity for $z = 0.15$ m, $D = 0.02$ m, and inlet pressures of 2 and 30 bar. The heat flux required to melt a 40% mass fraction of ice in the flow is also shown.

1. For the cases with tube length $z = 1$ m (Figs. 1 and 2), the heat flux required to melt the ice particulates is only a fraction of the CHF for the high-pressure case (30 bar), and thus, the addition of ice particulates would only marginally enhance the CHF based on this mechanism. For the low-pressure case (2 bar), the effect is quite significant, particularly for high mass velocities. For the case with $D = 0.01$ m, $q_{ice}'' > q_{cr}''(B)$ for mass velocities higher than $\sim 12\,000$ kg/m²·s. For the case with $D = 0.02$ m, $q_{ice}'' > q_{cr}''(B)$ for mass velocities higher than $\sim 6\,000$ kg/m²·s.

2. The heat flux required to melt the ice particulates is substantial for the case with $z = 0.15$ m when compared with the CHF, even for the high-pressure case. The concern here is whether the heat transfer mechanisms over the short tube

length would allow for very high heat fluxes while maintaining a reasonable wall temperature level.

3. In general, the results from Figs. 1 through 4 are very encouraging, suggesting that the effect of ice particulate melting could substantially enhance the allowable heat flux, particularly for cases with low z/D ratios and high mass velocities. In addition, the presence of ice particulates could allow for high-heat-flux removal (up to several tens of megawatts per square metre based on the sum of CHF/C and q_{ice}'') at low pressure (2 bar) if the desired combination of z/D and G values is allowed by the design and if the heat transfer mechanisms can accommodate complete ice melting. Typically, this system seems to be particularly appropriate for z/D ratios of ~ 20 or less. Other concerns relate to the pressure drop of the

system at high mass velocities and to the refrigerant power required, which could severely limit the surface area for high-heat-flux removal. These concerns are addressed in the next two sections.

4. The CHF values calculated from Eq. (2) and shown in Figs. 1 through 4 include the effect of maximizing the inlet subcooling. The effect of the inlet subcooling on the CHF depends on the tube dimensions and system pressure. As an example, Fig. 5 illustrates the effect of inlet subcooling on $q_{CHF}''(B)$ for different mass velocities for $z = 0.15$ m, $D = 0.01$ m, and $p = 2$ bar. The CHF seems to increase linearly with ΔT_{sub} , the net effect being substantial for the higher mass velocities in this case. For $G = 6000$ kg/m²·s or higher, the CHF is increased by a factor of 2.8 or more when ΔT_{sub} increases from 20 to 120 K. Thus, maximizing the inlet subcooling by setting the coolant temperature at the inlet at the melting point can significantly increase the CHF.

PRESSURE DROP CALCULATIONS

Estimation of the pressure drop for subcooled boiling in the absence of ice particulates is already a relatively complex process.^{10,11} The presence of ice particulates increases the complexity of the calculation and represents a field of study in which little work seems to have been done and that needs to be more thoroughly addressed. Here, as a simplifying assumption for our initial calculations, the pressure drop is calculated as a rough estimate of the pressure drop for the subcooled boiling regime. Under the assumption of a homogeneous particulate-water mix, the pressure drop for the flow with particulates can be expressed in a way similar to that for flow without particulates:

$$\Delta P(\beta = 0) = f_o \frac{z}{D} \left(\frac{\rho v^2}{2} \right)_o \tag{6}$$

and

$$\Delta P(\beta > 0) = f_{mix} \frac{z}{D} \left(\frac{\rho v^2}{2} \right)_{mix} \tag{7}$$

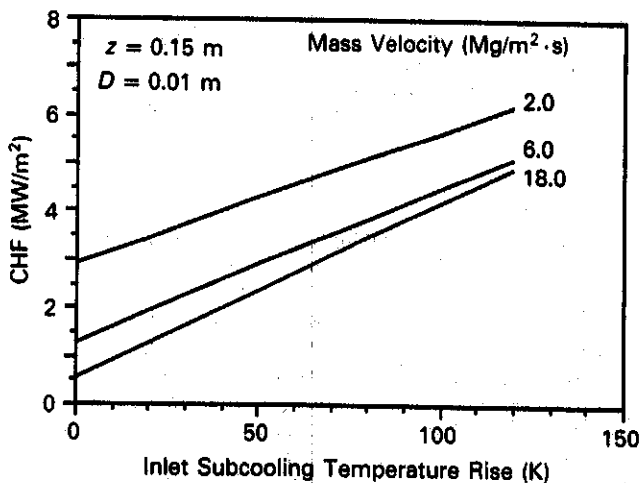

Fig. 5. The CHF based on the Bowring correlation as a function of inlet subcooling temperature rise for different mass velocities for $z = 0.15$ m, $D = 0.01$ m, and an inlet pressure of 2 bar.

where

- ΔP = pressure drop for flow in the nonboiling regime
- f = friction factor
- β = volumetric fraction of ice.

The subscripts *mix* and *o* refer to the flow with and without particulates, respectively. Under the assumption of a velocity slip coefficient (ratio of ice to water velocities) close to unity, β is related to F_{ice} as follows:

$$F_{ice} = \frac{1}{\frac{1 - \beta}{\beta} \frac{\rho_f}{\rho_{ice}} + 1} \tag{8}$$

where ρ_f/ρ_{ice} is the liquid water to ice density ratio. For a given z/D ratio, the ratio of pressure drop for flow with particulates to pressure drop for flow without particulates in the nonboiling regime can be expressed as follows:

$$\frac{\Delta P(\beta > 0)}{\Delta P(\beta = 0)} = \frac{(f \rho v^2)_{mix}}{(f \rho v^2)_o} \tag{9}$$

where v is the velocity. For an effective Reynolds number for the flow with particulates of 2×10^5 or less, the friction coefficient for hydrosuspensions may be estimated within an error of about $\pm 10\%$ based on a Blasius-like expression in analogy to single-phase flow¹³:

$$f_o = 0.316 Re_o^{-0.25} \tag{10}$$

and

$$f_{mix} = 0.316 Re_{mix}^{-0.25} \tag{11}$$

where

$$Re_o = \left(\frac{\rho v D}{\mu} \right)_o \quad \text{and} \quad Re_{mix} = \left(\frac{\rho v D}{\mu} \right)_{mix} \tag{12}$$

Substituting the friction factor from Eqs. (10) and (11) into Eqs. (6) and (7) and using the following viscosity relations from Cuppalo,¹³

$$\frac{\mu_{mix}}{\mu_o} = (1 - \beta)^{-2.8} \tag{13}$$

we can reformulate Eq. (9) as follows:

$$\frac{\Delta P(\beta > 0)}{\Delta P(\beta = 0)} = \frac{1}{(1 - \beta)^{0.7}} \left(\frac{\rho_{mix}}{\rho_o} \right)^{0.75} \left(\frac{v_{mix}}{v_o} \right)^{1.75} \tag{14}$$

Assuming

$$\frac{\rho_{ice}}{\rho_o} \approx 0.9 \tag{15}$$

then

$$\frac{\rho_{mix}}{\rho_o} = (1 - \beta) + \beta \frac{\rho_{ice}}{\rho_o} = 1 - 0.1\beta \tag{15}$$

Substituting ρ_{mix}/ρ_o from Eq. (15) into Eq. (14) and assuming for these preliminary calculations that v_{mix}/v_o is close to unity yields

$$\frac{\Delta P(\beta > 0)}{\Delta P(\beta = 0)} = \frac{(1 - 0.1\beta)^{0.75}}{(1 - \beta)^{0.7}} \tag{16}$$

Ebert et al. proposed the following alternate expression¹⁴ for hydrosuspensions:

$$\frac{\Delta P(\beta > 0)}{\Delta P(\beta = 0)} = 1 + \beta \left(N + \frac{1}{1 + \beta} \frac{\rho_s}{\rho_f} \frac{1}{1 + N} \right), \quad (17)$$

where N is a function of the solid-to-liquid density ratio, and ρ_s and ρ_f are the densities of solid particulates and liquid, respectively. For an ice-water mix, $\rho_s = \rho_f$ and $N = 0$. Then,

$$\frac{\Delta P(\beta > 0)}{\Delta P(\beta = 0)} = 1 + \frac{0.9\beta}{(1 + \beta)} \quad (18)$$

Equations (16) and (18) provide two possible ways of estimating the ratio of pressure drop for flow with ice particulates to pressure drop for flow without particulates. For the preliminary calculations presented here, Eq. (16), which seems to be slightly more conservative, is used in conjunction with Eq. (6) to obtain a rough estimate of the pressure drop for flow with particulates in the subcooled regime. The results are intended to provide only an order-of-magnitude approximation and need to be further refined to more accurately determine the pressure drop value for particulate flow in the subcooled boiling regime. Figures 6 and 7 show the pressure drop as a function of the ice volumetric fraction for different mass velocities and for z/D ratios of 20 and 100, respectively. The tube diameter in both cases was set at 0.01 m. Because the pressure drop increases linearly with the z/D ratio, it is desirable that this ratio be minimized to allow for the possibility of operation at low pressure (~1 to 2 bar). A z/D ratio of 20 would result in a pressure drop of ~0.2 bar for β and G of 0.4 and 10^4 kg/m²·s, respectively.

Both the heat flux and pressure drop results indicate that such a cooling system is most applicable to small z/D ratios to provide the advantage of high-heat-flux removal for low system pressure and coolant pressure drop.

REFRIGERATION POWER AND ICE PRODUCTION RATE REQUIREMENTS

To have a close coolant circuit, the outlet coolant must be refrigerated to bring the coolant to the melting point and

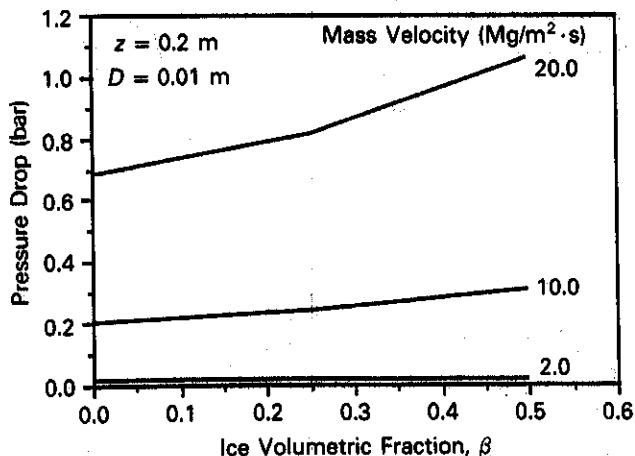

Fig. 6. Pressure drop as a function of ice volumetric fraction for different mass velocities for a tube length of 0.2 m and diameter of 0.01 m.

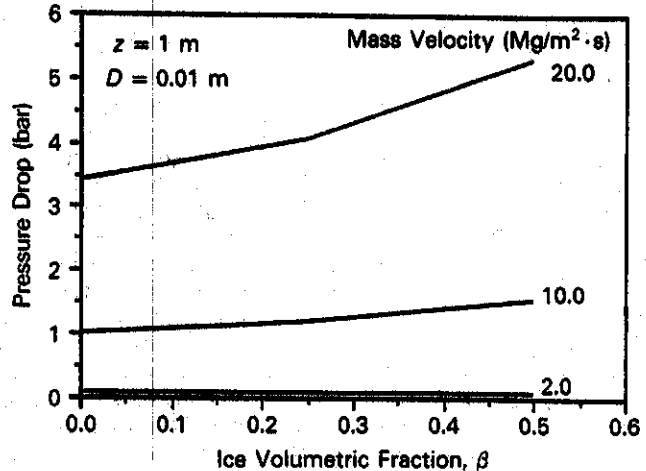

Fig. 7. Pressure drop as a function of ice volumetric fraction for different mass velocities for a tube length of 1 m and diameter of 0.01 m.

to produce the ice particulates. This means that the total heat flux q_{tot}'' removed has to be accommodated by the refrigeration system. For a water-ice particulate system, the inlet temperature is low (273 K) and creates a heavy demand on the refrigeration system. There might be other combinations of liquid and particulates that would reduce the refrigeration requirement; this is an interesting followup topic that should be addressed in more detail in the future.

For the subcooled water-ice particulate system, the required refrigeration power W_r can be estimated from

$$W_r = \frac{q_{tot}'' A_s}{COP}, \quad (19)$$

where

COP = coefficient of performance of the refrigeration equipment

A_s = surface area being cooled.

Thus, for an assumed COP of ~5 to 10, the refrigeration power required per unit area cooled is substantial, ~10 to 20% of the heat flux removal. For example, for a total heat flux removed of 30 MW/m² over an area of 10 m², the refrigeration power is ~30 to 60 MW. This would limit the surface area to be cooled.

Ice production rate requirements might also impose a limit on the total heat rate to be removed. For an assumed mass velocity of 3000 kg/m²·s and a flow area of 0.01 m²/m² heating surface area, the required ice production rate is ~50 000 kg/h. Several large industrial ice-making units would probably be needed, and the capital cost and complexity of the system would have to be taken into account when deciding on the total heat rate removal by the ice particulate flow.

APPLICATION TO DIVERTOR PROBLEM

According to the initial results, subcooled water-ice particulate flow seems to be more applicable for cooling of relatively small surface areas with high local heat fluxes, where a conventional cooling system would come short of providing

the required heat removal at acceptable coolant pressure levels. A typical application would be for plasma-facing components of a nuclear fusion reactor, such as for part of the divertor with high peak heat fluxes.

For example, the divertor plates for the ITER CDA design have an area of $\sim 200 \text{ m}^2$ and a total heat load of at least 100 MW (Ref. 1). However, the peak power densities, including an engineering peaking factor, are as high as 30 MW/m^2 . These peak fluxes occur over a relatively small area. Separatrix sweeping would result in lower peak heat fluxes over a larger area. For divertor application, the ice particulate flow could be routed to these regions of peak heat fluxes to keep the z/D ratio low for acceptable cooling performance. For instance, if a peak heat flux of $\sim 20 \text{ MW/m}^2$ is assumed over a region of 24-cm poloidal thickness based on separatrix sweeping ($\pm 12 \text{ cm}$), z/D will be ~ 24 for poloidal flow in a 1-cm pipe. The CHF based on the Bowring correlation is $\sim 4.8 \text{ MW/m}^2$ for an inlet pressure of 2 bar and a mass velocity of $15000 \text{ kg/m}^2 \cdot \text{s}$. For this case, $\sim 16 \text{ MW/m}^2$ would be required to melt the ice particulates for an inlet volumetric ice fraction of $\sim 30\%$. Thus, if the heat transfer mechanisms do allow for complete ice melting, a peak heat flux of 20 MW/m^2 could be accommodated with a low-pressure water coolant with a 30% ice fraction. This simple example is used as an illustration of the potential of ice particulate flow as a coolant. Further analyses and experimental studies are required to determine the exact extent to which ice particulate flow would increase the allowable heat fluxes, in particular for divertor-type cases with one-sided heating. For this example, if the entire 100-MW heat load to the divertor is removed by the melting ice, the refrigeration power requirements would be ~ 10 to 20 MW, depending on the coefficient of performance.

A schematic of such a cooling system is shown in Fig. 8.

The mixture of water and ice particulates enters the high-heat-flux component and cools the superheated wall surface by means of surface subcooled boiling and ice melting. In addition, the diverted mix jets can be directed to regions of high local heat fluxes if required. At the exit, any remaining ice particulates are separated from the outlet water, which then goes through a water cooler and is refrigerated to a temperature of 273 K. Next, the water is separated into a stream that is further refrigerated through a fine ice maker. The ice particulates are then mixed with the remaining water stream before being cycled back to cool the high-heat-flux component.

Optimization of the coolant system might result in different combination and location of ice jets along the channel, depending on the heat flux profile. In all cases, best results are obtained with small z/D ratios (~ 20 or less). In addition, it seems that for maximizing the enhancement of the mixing process through particulate motion and interaction with bubbles, the particulate size should be chosen so as not to exceed the size of the wall boundary region.

CONCLUSIONS

The preliminary analysis presented here indicates that the proposed phase-change fluid and particulate cooling system represented by a mixture of subcooled boiling water and ice particulate has good potential for high-heat-flux removal capability with low to moderate system pressure. The cooling system seems most effective for low ratios of tube length to diameter and for small surface areas to be cooled, based on reasonable pressure drop and refrigeration power requirement. The concept also has the potential of increasing the heat transfer process by enhancing the mixing process through particulate motion and interaction with bubbles.

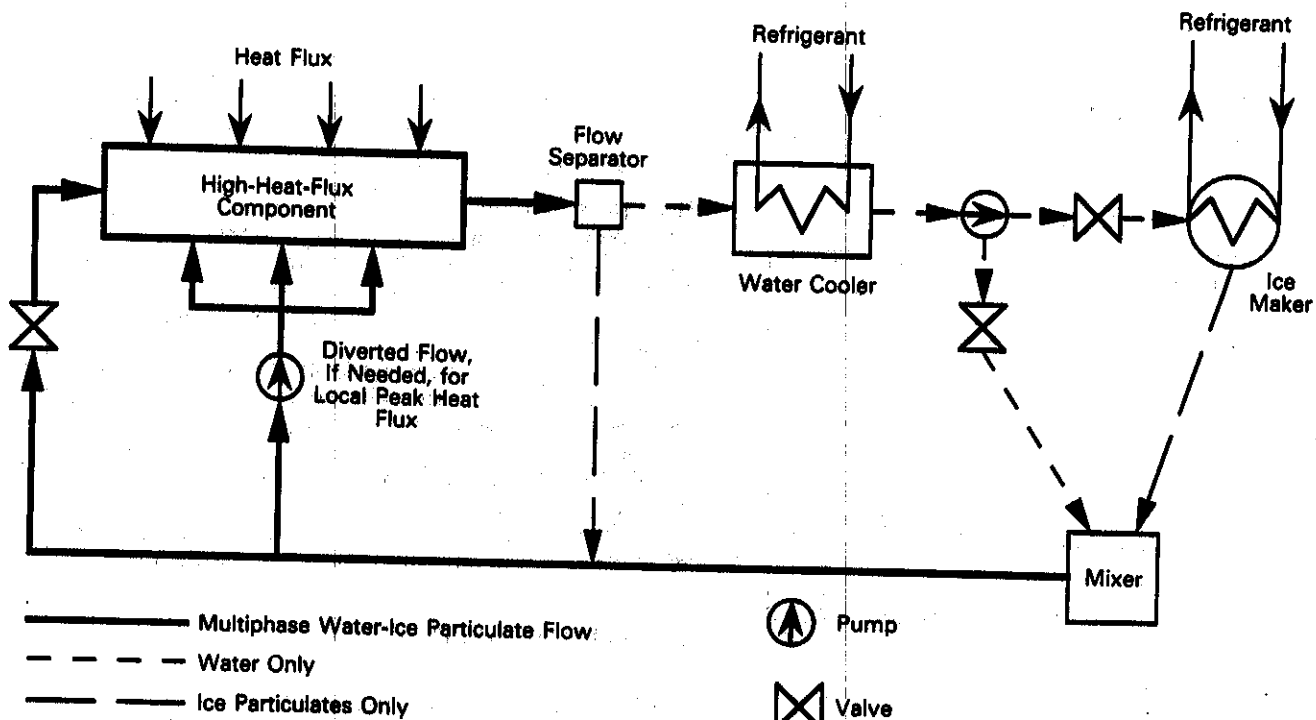

Fig. 8. Schematic of phase-change fluid and particulate flow cooling system.

Several issues have been identified that need to be addressed by future work. In particular, detailed analytical and experimental studies are required to

1. investigate the effect of the presence of ice particulates on the internal coolant heat transfer and surface boiling processes, particularly the effect of ice particulate motion and interaction with bubbles and wall surface on the mixing and heat transfer processes between the wall region and the bulk and the corresponding effect on the CHF. The investigation should also address the possibility of particulate agglomeration, which could result in an effective decrease in the core diameter and hence in the CHF.
2. better analyze the pressure drop in channel for flow in the subcooled boiling regime in the presence of ice particulates
3. estimate the overall pressure drop in the cooling system and pumping power requirement
4. assess the potential use of other fluid/particulate combinations for high-heat-flux removal
5. assess the effect on the choice of structural material of operation at particulate flow temperature and of particulate flow/wall interaction.

NOMENCLATURE

A	= parameter described by Eq. (3)
A_s	= surface area being cooled (m^2)
B	= parameter described by Eq. (4)
C	= safety factor for CHF
C_{pf}	= specific heat of water ($J/kg \cdot K$)
D	= tube diameter (m)
F_1, F_2, F_3, F_4	= parameters based on system pressure in Barnett and Macbeth CHF expression
F_{ice}	= mass fraction of ice
f	= friction factor
G	= mass velocity of coolant ($kg/m^2 \cdot s$)
h_{fg}	= latent heat of vaporization of water (J/kg)
h_{ice}	= ice latent heat of fusion (J/kg)
n	= parameter described by Eq. (5)
P	= pressure (bar)
$q''_{cr}(B)$	= CHF based on Barnett and Macbeth expression and Bowring correlated parameter values
q''_{ice}	= heat flux accommodated by melting ice (W/m^2)
q''_{tot}	= total flux removed (W/m^2)
Re	= Reynolds number
v	= velocity (m/s)
W_r	= refrigeration power requirement (W)
z	= tube length (m)
Greek	
β	= volumetric fraction of ice
ΔP	= pressure drop (Pa)

ΔT_{sub}	= inlet subcooling temperature rise (K)
μ	= viscosity ($Pa \cdot s$)
ρ	= density (kg/m^3)
Subscripts	
f	= liquid
ice	= ice
mix	= flow with particulates
o	= flow without particulates
s	= solid

REFERENCES

1. G. VIEIDER et al., "ITER Plasma Facing Components, Design and Development," *Fusion Eng. Des.*, 16, 23 (1991).
2. S. A. COHEN and R. F. MATTAS, "ITER Divertor Design: Physics, Engineering and R & D Requirements," U.S. ITER Background Summary Papers (May 1991).
3. R. NYGREN, "Techniques to Enhance Heat Removal," presented at Workshop Innovative Technologies for Impurity Control, Princeton, New Jersey (Jan. 1990).
4. R. D. BOYD, "Subcooled Water Flow Cooling at 1.66 MPa Under Uniform High Heat Flux Conditions," *Fusion Technol.*, 16, 324 (1989).
5. M. ARAKI et al., "Burnout Experiments on the Externally Finned Swirl Tube for Steady-State and High-Heat Flux Beam Stops," *Fusion Eng. Des.*, 9, 231 (1989).
6. V. O. VODYANYAK et al., "Liquid-Metal Tokamak Limiter: Statement of the Problem and First Results," *Sov. J. Plasma Phys.*, 14, 5 (1988).
7. C. LIAO and M. KAZIMI, "A Feasibility Assessment of Liquid Metal Divertors," *Fusion Technol.*, 21, 1845 (1992).
8. Z. R. GORBIS and M. I. BERMAN, "Experimental Study of Boiling on Heat Surface During the Thermal Fluidization of a Bed of Particles," translated from *Inzhenerno-Fizicheskii Zhurnal*, 27, 3 (1974), by Plenum Press (1976).
9. M. I. BERMAN and Z. R. GORBIS, "Heat Transfer During Boiling on Heating Surfaces in a Disperse Layer of Solid Particles: Analysis and Generalization of Experimental Data," translated from *Inzhenerno-Fizicheskii Zhurnal*, 38, 1 (1980), by Plenum Press (1980).
10. A. M. KUTEPOV, *Hydrodynamic and Heat Transfer of Boiling*, Visshaya Shkola, Moscow (1977) (in Russian).
11. J. G. COLLIER, *Convective Boiling and Condensation*, McGraw-Hill Book Company, New York (1981).
12. "Tabular Data for Calculating Burnout When Boiling Water in Uniformly Heated Round Tubes," *Teplotenergetika*, 23, 9, 90 (1976) (in Russian).
13. Z. R. GORBIS, *Heat Transfer and Hydromechanics of Through Dispersion Flows*, Energiya, Moscow (1970) (in Russian).
14. F. EBERT, L. PLASS, and P. WELLMAN, "Experimental Studies on Turbulent Flow of Ore Suspensions in Horizontal Pipes," *Chemie Ing. Tech.*, 48, N1 (1976).