

Detailed Information on Proposal for
UNICEX-Hi

US-Monbusho Collaboration

Thermal-Mechanical Interactions
for the SiC / SiC-Pebble Breeder / Be / He System

Responsible Persons

Japan: Akiro Kohyama

US: Mohamed Abdou

- **Objectives**
- **Temperature Window**
- **Test Articles**
- **Schedule**
- **Cost**
- **UCLA Capabilities**

UNICEX-Hi

Thermal-Mechanical Interactions for the SiC/SiC-Pebble Bed Breeder / Be / He System

Primary Objectives

1. Investigate the ability to achieve and maintain an acceptable temperature profile in the SiC / He / Ceramic Breeder / Be material system
 - Key: Measure interface thermal resistance at the SiC / Ceramic pebble bed breeder and at the SiC / Be interfaces (under different conditions: different SiC composites, pebble size(s), porosity, helium purge pressure and temperature, etc.)
 - Obtain data and develop innovative techniques for predicting and controlling the temperature response in the material system (especially at interfaces).
 - Determine the temperature window (min. and max.) in which SiC will have to operate based on the material system thermal constraints.

Primary Objectives (Cont'd)

2. Investigate thermal-mechanical interactions

e.g.:

- effect of mismatch in thermal coefficient of expansion between SiC-pebble bed breeder and SiC-beryllium or the pebble bed integrity and mechanical deformation in SiC / SiC (compaction or breaking SB pebbles?, micro-cracks in SiC?)
- Can high pressure helium coolant be flown directly into a ceramic pebble bed in order to raise the operating temperature of SiC / SiC?
(Stability issues: variation in pebble bed fraction → higher local temperature → larger pebble deformation → even smaller void fraction → ??)

3. Provide fundamental scientific and engineering input to the design of irradiation experiments

- material temperature range
- material form
- basic material property changes without irradiation

Other Possible Objectives (see next page)

Other Possible Objectives

- ❖ To provide data on short-term temperature effects on chemical compatibility
- ❖ Determine cyclic effects
- ❖ Test effectiveness of hermetic seals developed in other tasks and measure helium leak rates as a function of temperature history and oxygen vapor pressure

Additional Notes on Objectives for Thermomechanics Tests (UNICEX-Hi)

- ◆ **The use of SiC/SiC in these laboratory experiments increases the cost and difficulty of the experiments.**
 - **Some engineering issues (e.g. joining techniques for SiC) will need to be addressed.**
- ◆ **However, such information is essential for planning a meaningful roadmap for material systems with SiC**
- ◆ **The UNICEX task will also be very useful in:**
 - **Integrating a number of technical disciplines and technical issues**
 - **Providing boundary conditions for SiC based on Be/Ceramic Breeder consideration (and vice versa)**
 - **Providing an opportunity for scientists and engineers in the material and blanket communities to work together.**

Temperature Window

- Ceramic breeder (typically)

$$T_{\min} > 400^{\circ}\text{C}$$

$$T_{\max} < 800^{\circ}\text{C} \text{ (or } 900^{\circ}\text{C)}$$

- Also, k is low ($\sim 1\text{W/m}\cdot\text{K}$) and region thickness must be significant (T-breeding)

- Beryllium (typically): $T_{\max} < 600^{\circ}\text{C}$

- Interface thermal resistance between ceramic breeder (or Be) and structure can be large, several hundred degrees, depending on pebble bed size, helium purge conditions, surface roughness and other characteristics, external load, etc.

$$h_{\text{conductance}} \sim 500 - 5000 \text{ W/m}^2\text{-K}$$

$$\Delta T \text{ (interface)} \sim 30 - 300^{\circ}\text{C}$$

- The temperature window issue for pebble bed breeders and Be is fundamentally different with SiC / SiC from that with metallic alloys. The interface thermal resistance is critical for SiC systems

- For metallic alloys:
key issue is to keep $T_{\text{breeder}} \text{ (low)} > T_{\min}$

- For SiC / SiC

Can we operate SiC at high enough temperature (thermal conductivity and radiation damage requirement) without exceeding $T_{\max}^{\text{breeder}}$ or T_{\max} (Be)

Thermal Interface Conductance is Critical for SiC/SiC

- 1) to maintain SiC temperature above the limit for radiation-induced conductivity degradation (i.e. above 600 °C)
- 2) to keep He coolant temperature high for a high efficiency (> 600 °C)

- **Maximum breeder temperature must be < 900 °C**
- **Thermal conductivity of ceramic breeder bed is low ~ 1-1.2 W/mK**
- δ_{SB} **must be large enough for TBR (taken 1 cm here)**
- **Interface thermal conductance is highly uncertain and function of many parameters**

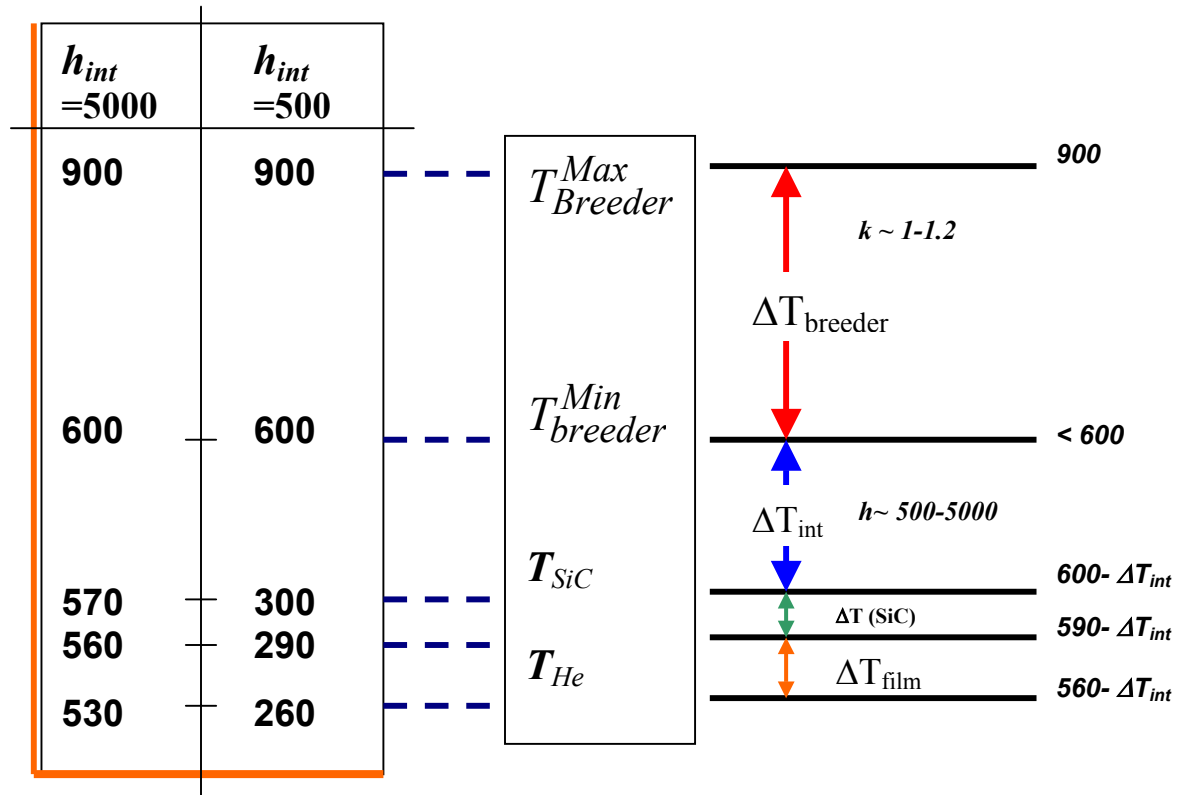

Conclusion

- *Attaining high interface thermal conductance is essential for practical utilization of SiC*
- *Note that similar conclusions are obtained when a maximum beryllium temperature (~ 600-700 °C) is imposed*

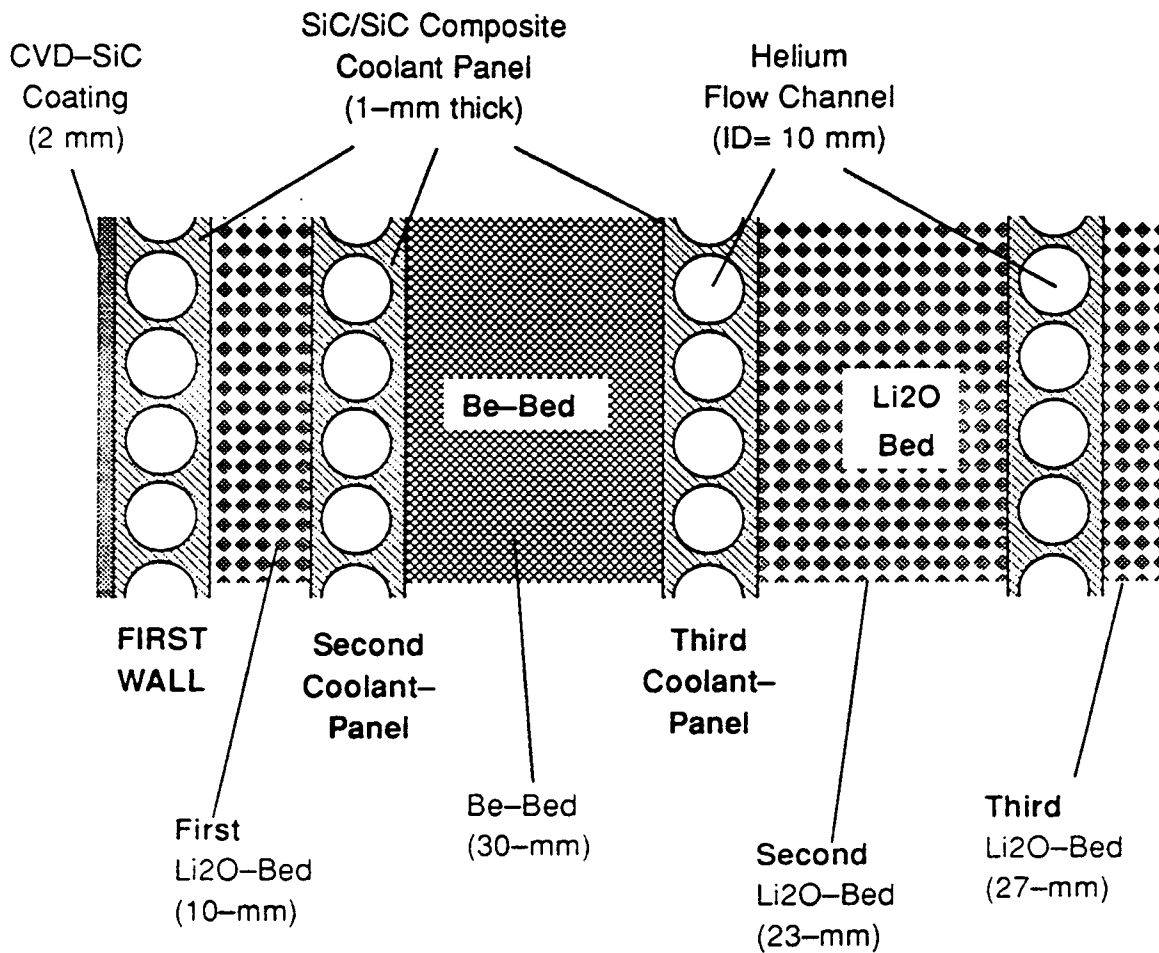

Figure II.26: Schematic showing the details of the helium cooled solid breeder SiC/SiC composite blanket cross-section (only the first three of eleven zones are shown).

Examples of Test Configurations in the UNICEX-Hi

- A number of test configurations (~5) will be performed sequentially over a period of time (4 years). Note that each configuration may involve several test articles.
- These test configurations will proceed from simple to more involved as dictated by scientific reasons and the pace of information available from other tasks (e.g. material fabrication R&D and hermetic joining for SiC/SiC)

Proposed UNICEX-Hi SiC/SiC-Based Pebble Bed Test Matrix

Year	Test Configuration Feature *	Main Objectives
2001-2002	1. Non-cooled SiC tube and plate(s) 2. Non-cooled SiC plate(s)	➤ Temperature prediction and material interactions ➤ Thermal-mechanical deformation
2002-2003	3. Non-cooled SiC plate/sintered Beryllium plate 4. Helium-cooled SiC tube coolant plenum	➤ Temperature prediction and material interactions ➤ Thermal hydraulics, temperature prediction, and material interactions
2003-2004	5. SiC-based Unit cell	➤ Thermomechanics interaction and prediction

* All configurations have ceramic breeder and/or beryllium in pebbled bed form unless specified otherwise

Test Configuration I

Non-helium Cooled SiC plate with Pebble Bed (ceramic breeder or beryllium)

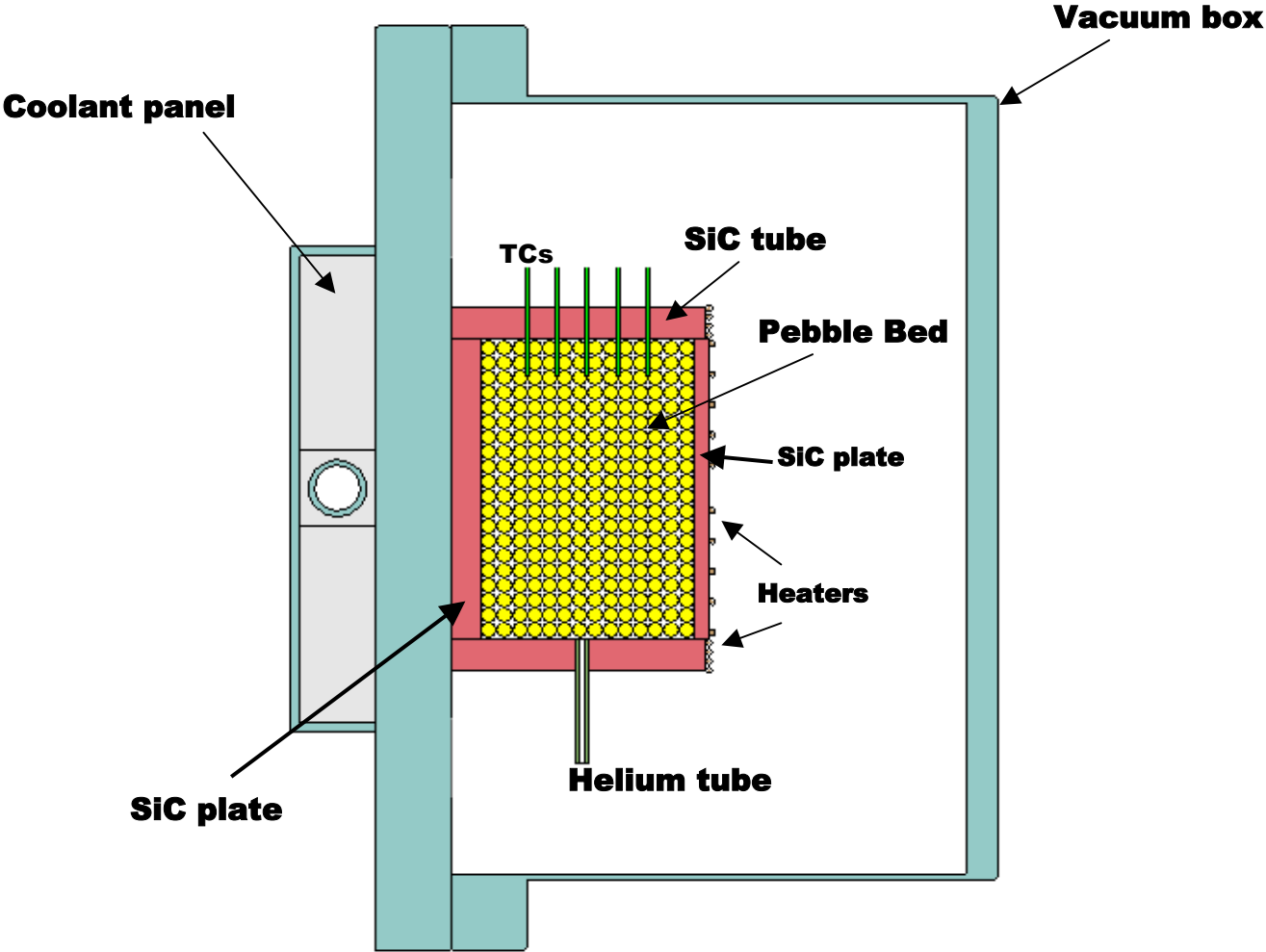

**Non-helium Cooled SiC Plate with pebble ceramic breeder or beryllium pebble
(Isometric View) SiC/SiC based test article size: 10 cm x 10 cm
(for illustration only; engineering design is subject to state-of-the-art SiC/SiC manufacturing techniques)**

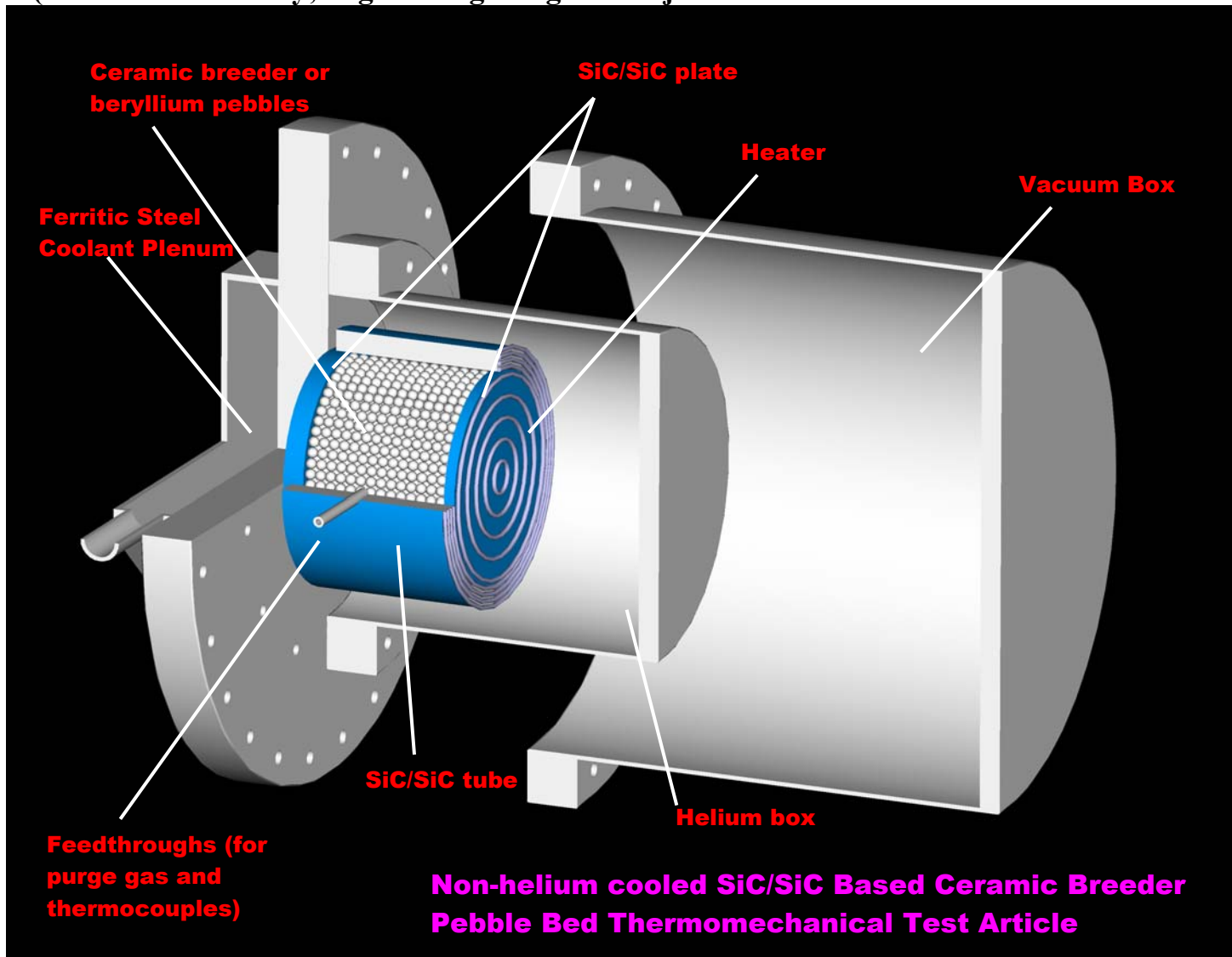

Test Configuration 3

Effect of SiC/SiC Surface Characteristics on Interface Thermal Conductance

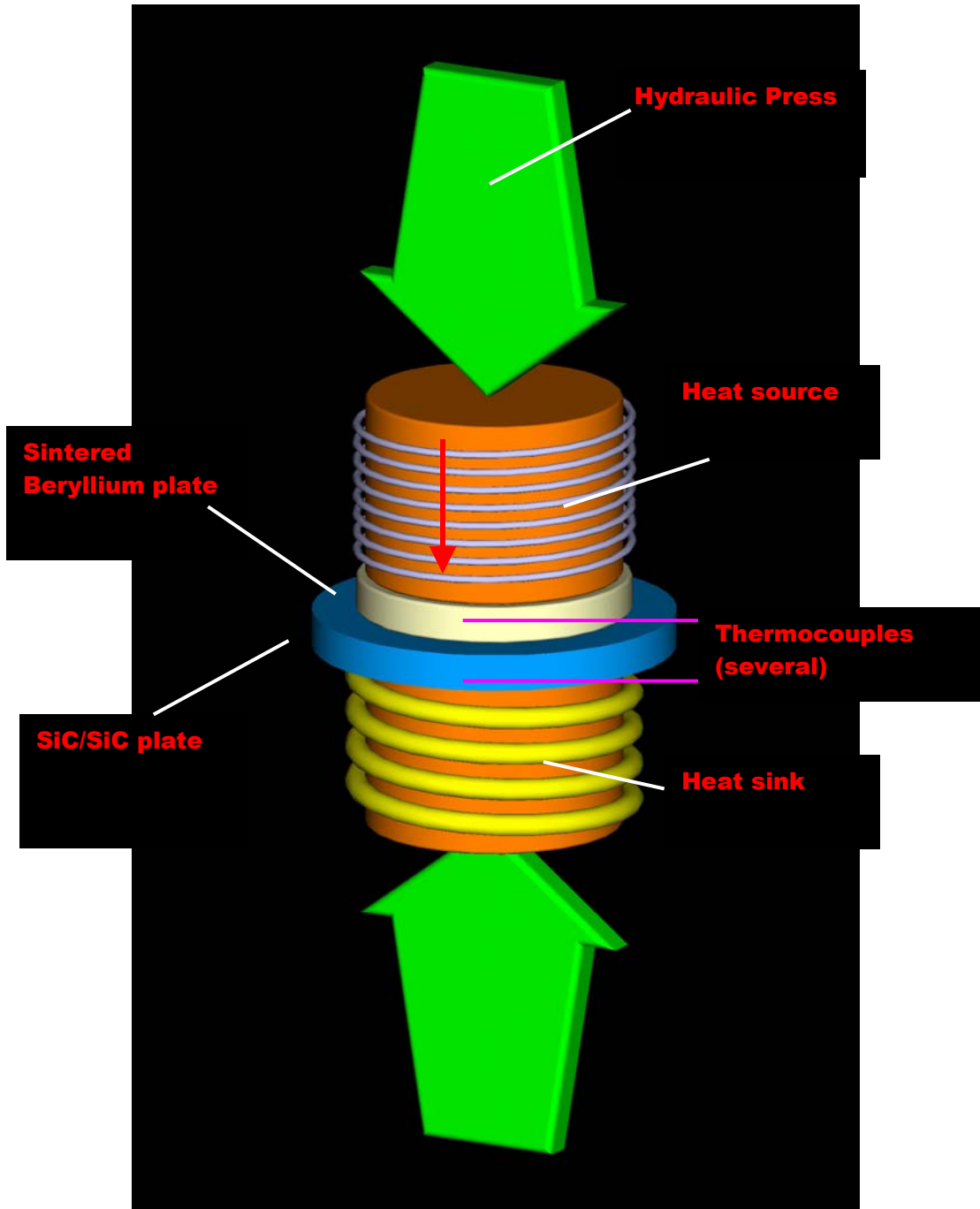

Test Configuration 4 (schematic view)

Helium-Cooled SiC/SiC

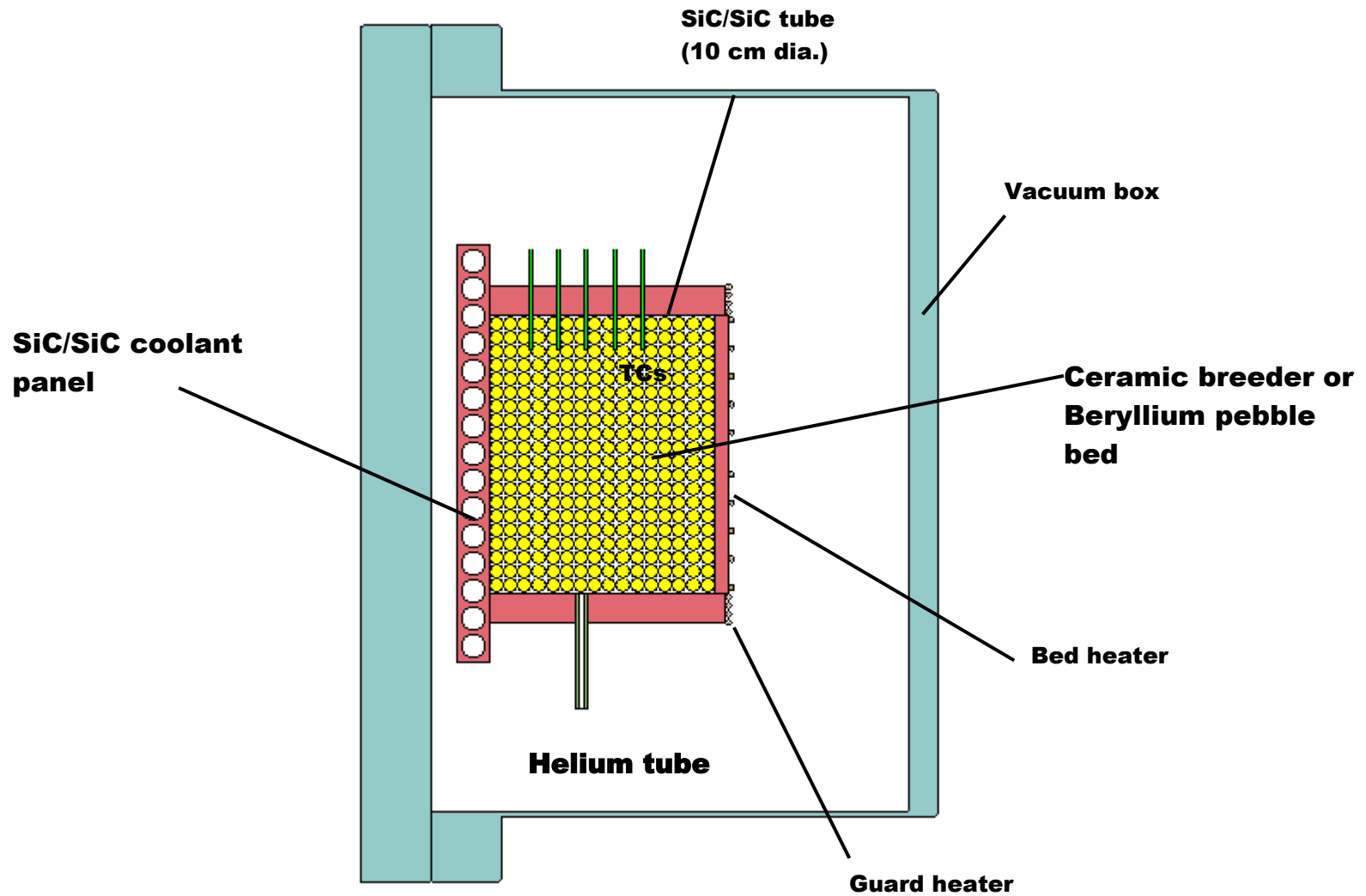

Helium-Cooled SiC Tube with pebble ceramic breeder or beryllium pebble Test Article

(for illustration only; engineering design is subject to state-of-the-art SiC/SiC manufacturing techniques)

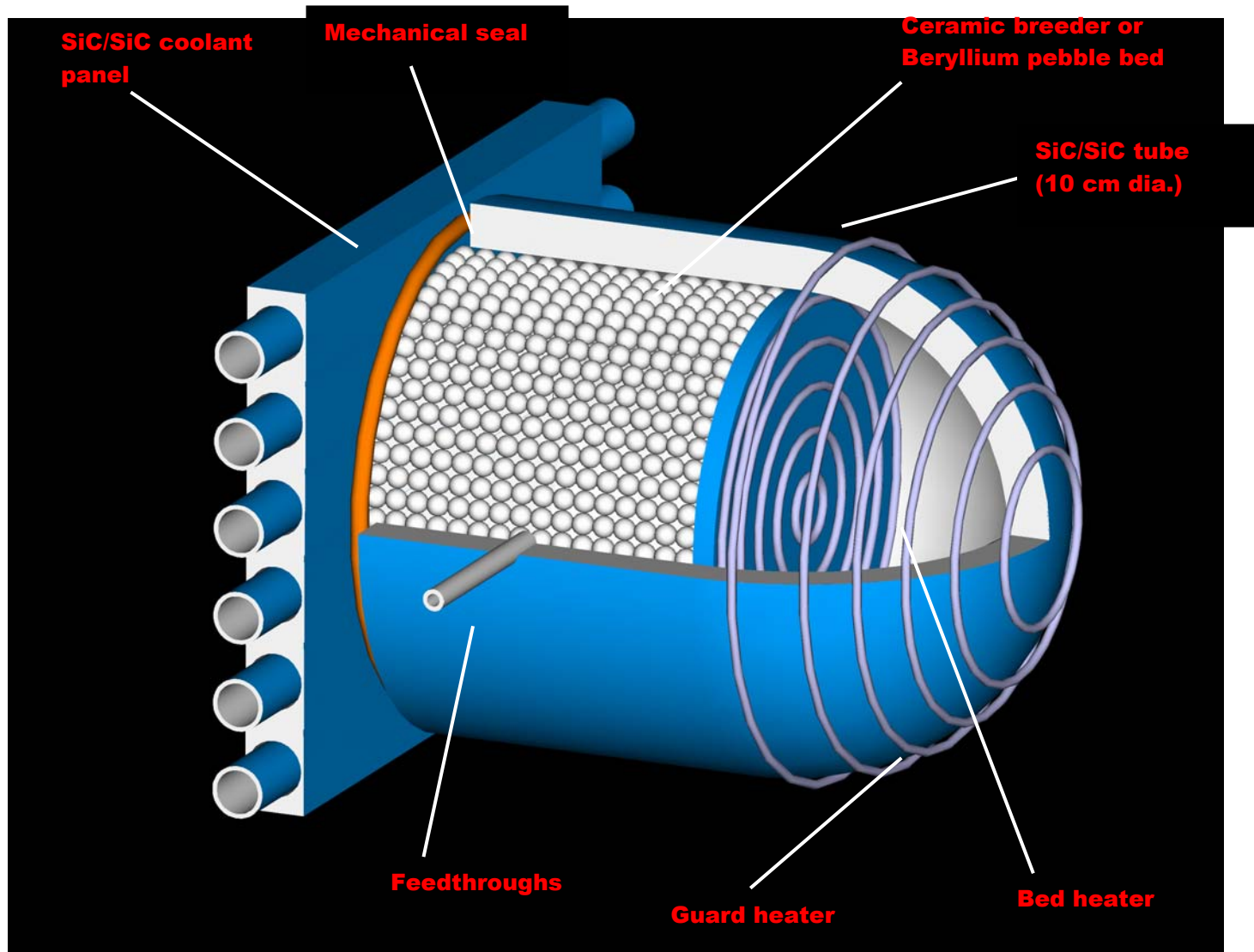

Test Configuration 5 (Unit Cell Experiment)

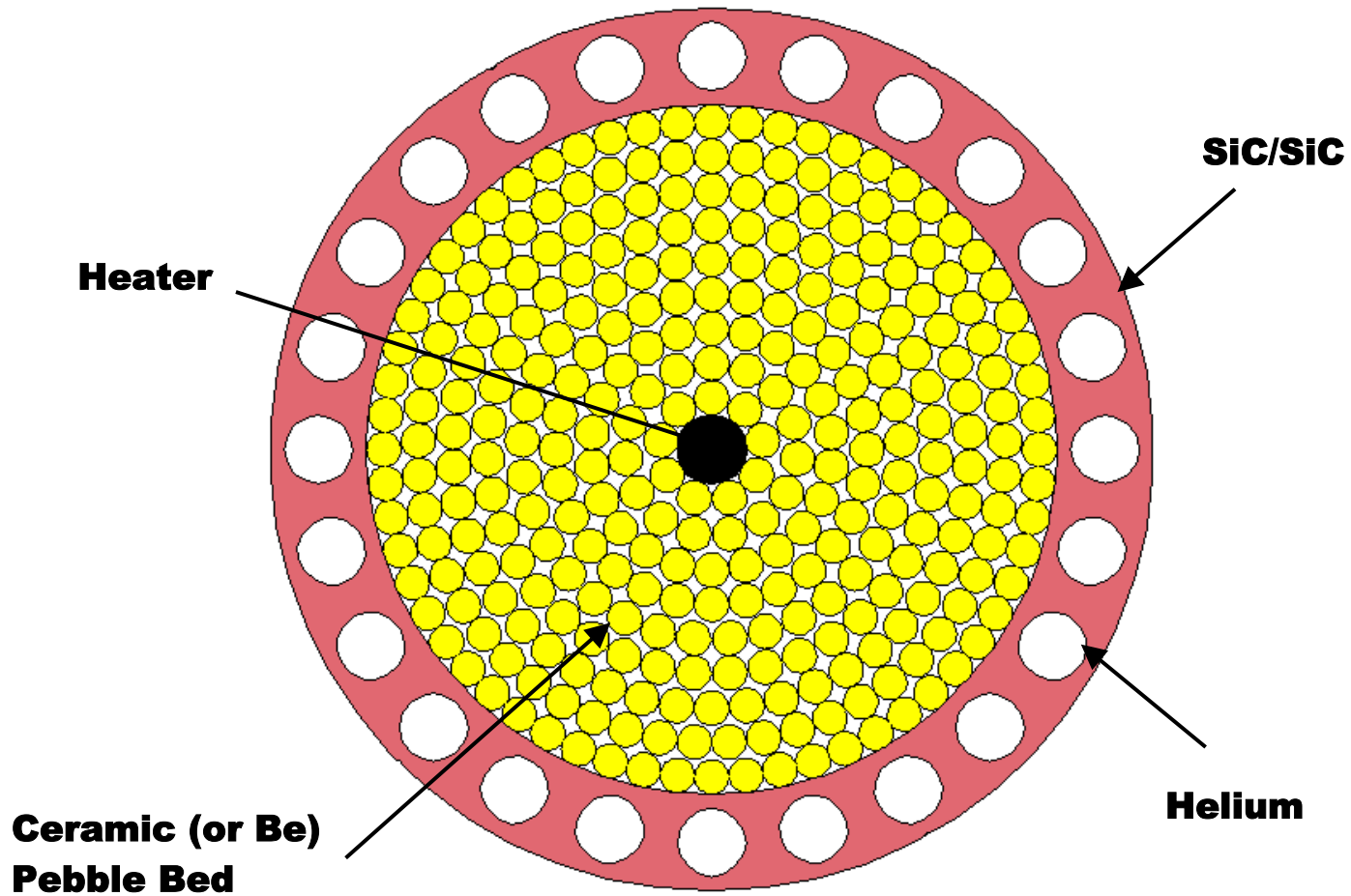

Test Matrix Details

Test Configuration	SiC/SiC Form	SiC/SiC Dimensions	Pebble bed material volume	Operating temperature (at coolant or breeder material (BM) interface)	Operating pressure (Helium)
1	Circular plates & tube	5- 10 cm dia. 10 cm long < 1 cm thick	~ 0.8 liters	250 to 400 °C at coolant interface	Low (2 atm)
2	Circular plates	5-10 cm dia. 0.25 cm thick	~ 0.4 liters	Max. 1000 °C at BM interface	Low
3	Circulate Plates	2.5 cm dis. 2.5 cm thick	Sintered beryllium block	Max. 600 °C at BM interface	Low
4	Coolant Tube Panel and Tube Clad	For coolant tube (1 cm dia.)	~ 0.8 liters	> 800 °C at coolant interface	High (6 MPa)
5	Coolant Tube Panel and plenum (TBD)	Panel size= 10 cm dia. 30 cm long	~ 2.5 liters	> 800 °C at coolant interface	High (6 MPa)

Note: Helium coolant flow rate for Test Configurations 4 (low ΔT) and 5 (high ΔT): 25 liters per second

Costs (Total contributions: US= 550k JA= 550k)

(Does not include SiC/SiC costs)

- **Test Article Fabrication: 6x25k+2x50k (total =\$250k)**
(customized heaters, high temperature vacuum seal, heat flux sensors, thermocouples, displacement transducers, strain gauges)
- **High Temperature, High Pressure Helium Cooling Loop \$200k**
(Helium circulation loop and purification systems)
- **Data Acquisition Upgrade \$25k**
- **Data Analysis Cost (e.g., SEM, micrograph) (total=\$50k)**
- **Operation and maintenance of UNICEX-Hi facility: \$600k over 4 years**

UNICEX-Hi Schedule

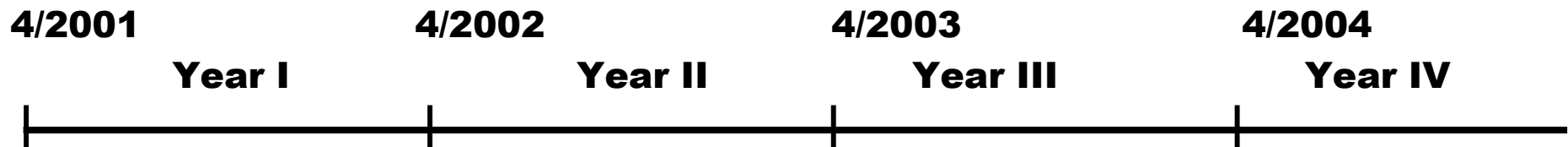

Test Configuration 1



Test Configuration 2



Helium-coolant Loop Upgrade



Test Configuration 3



Test Configuration 4



Test Configuration 5 (Unit Cell)



Inputs to Subtask 2.2

Legend

- Design and fabrication**
- Operation**
- Post experiment examination**
- Definition**

