

# The Synthesis of Complex Audio Spectra by Means of Frequency Modulation

JOHN M. CHOWNING

*Stanford Artificial Intelligence Laboratory, Stanford, California*

A new application of the well-known process of frequency modulation is shown to result in a surprising control of audio spectra. The technique provides a means of great simplicity to control the spectral components and their evolution in time. Such dynamic spectra are diverse in their subjective impressions and include sounds both known and unknown.

**INTRODUCTION:** Of interest in both acoustical research and electronic music is the synthesis of natural sound. For the researcher, it is the ultimate test of acoustical theory, while for the composer of electronic music it is an extraordinarily rich point of departure in the domain of timbre, or tone quality. The synthesis of natural sounds has been elusive; however, recent research in computer analysis and synthesis of some tones of musical instruments [1] has yielded an insight which may prove to have general relevance in all natural sounds: *the character of the temporal evolution of the spectral components is of critical importance in the determination of timbre.*

In natural sounds the amplitudes of the frequency components of the spectrum are time-variant, or dynamic. The energy of the components often evolve in complicated ways; in particular, during the attack and decay portions of the sound. The temporal evolution of the spectrum is in some cases easily followed as with bells, whereas in other cases not, because the evolution occurs in a very short time period, but it is nevertheless perceived and is an important cue in the recognition of timbre. Many natural sounds seem to have characteristic spectral evolutions which, in addition to providing their "signature," are largely responsible for what we

judge to be their lively quality. In contrast, it is largely the fixed proportion spectrum of most synthesized sounds that so readily imparts to the listener the electronic cue and lifeless quality.

The special application of the equation for frequency modulation, described below, allows the production of complex spectra with very great simplicity. The fact that the temporal evolution of the frequency components of the spectrum can be easily controlled is perhaps the most striking attribute of the technique, for dynamic spectra are achieved only with considerable difficulty using current techniques of synthesis. At the end of this paper some simulations of brass, woodwind, and percussive sounds are given. The importance of these simulations is as much in their elegance and simplicity as it is in their accuracy. This frequency modulation technique, although not a physical model for natural sound, is shown to be a very powerful perceptual model for at least some.

## FREQUENCY MODULATION

Frequency modulation (FM) is well-understood as applied in radio transmission, but the relevant equations have not been applied in any significant way to the generation of audio spectra where both the carrier and

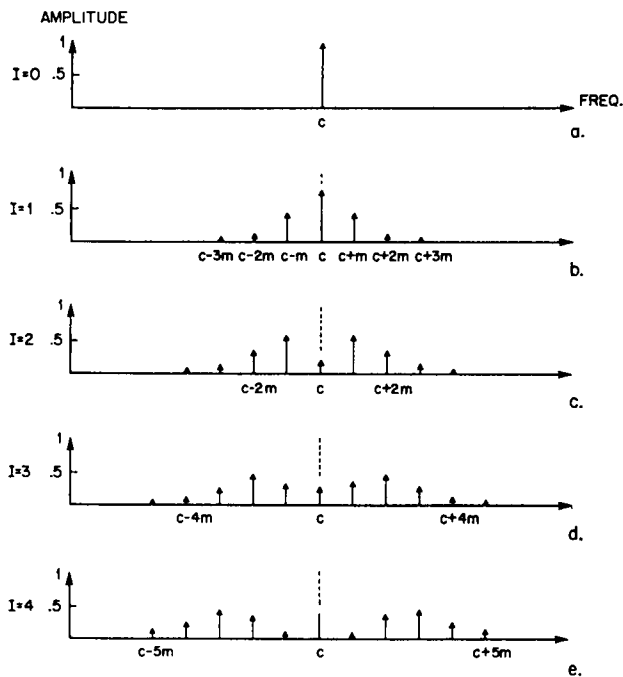

Fig. 1. Example to show increasing bandwidth with increasing modulation index,  $I$ . The upper and lower side frequencies are at intervals of the modulating frequency,  $m$ , and are symmetrical around the carrier,  $c$ .

the modulating frequencies are in the audio band and the side frequencies form the spectrum directly.

In FM, the instantaneous frequency of a carrier wave is varied according to a modulating wave, such that the rate at which the carrier varies is the frequency of the modulating wave, or modulating frequency. The amount the carrier varies around its average, or peak frequency deviation, is proportional to the amplitude of the modulating wave. The parameters of a frequency-modulated signal are

- $c$  = carrier frequency or average frequency
- $m$  = modulating frequency
- $d$  = peak deviation.

The equation for a frequency-modulated wave of peak amplitude  $A$  where both the carrier and modulating waves are sinusoids is

$$e = A \sin(\alpha t + I \sin \beta t) \quad (1)$$

where

- $e$  = the instantaneous amplitude of the modulated carrier
- $\alpha$  = the carrier frequency in rad/s
- $\beta$  = the modulating frequency in rad/s
- $I = d/m$  = the modulation index, the ratio of the peak deviation to the modulating frequency.

It is obvious that when  $I = 0$  the frequency deviation must also be zero and there is no modulation. When  $I$  is greater than zero, however, frequencies occur above and below the carrier frequency at intervals of the modulating frequency. The number of side frequencies which occur is related to the modulation index in such a way that as  $I$  increases from zero, energy is "stolen" from the carrier and distributed among an increasing number of side

frequencies. This increasing bandwidth as  $I$  increases, is shown in Fig. 1, with a constant-modulating frequency.

The amplitudes of the carrier and sideband components are determined by Bessel functions of the first kind and  $n$ th order,  $J_n(I)$ , the argument to which is the modulation index. The first six Bessel functions,  $J_0$  through  $J_5$ , are shown in Fig. 2. The 0th order Bessel function and index  $I$ ,  $J_0(I)$ , yields an amplitude scaling coefficient for the carrier frequency; the 1st order,  $J_1(I)$ , yields a scaling coefficient for the first upper- and lower-side frequencies; the 2nd order,  $J_2(I)$ , for the second upper- and lower-side frequencies; and so forth. The higher the order of the side frequency the larger the index must be for that side frequency to have significant amplitude. The total bandwidth is approximately equal to twice the sum of the frequency deviation and the modulating frequency, or

$$BW \approx 2(d+m).$$

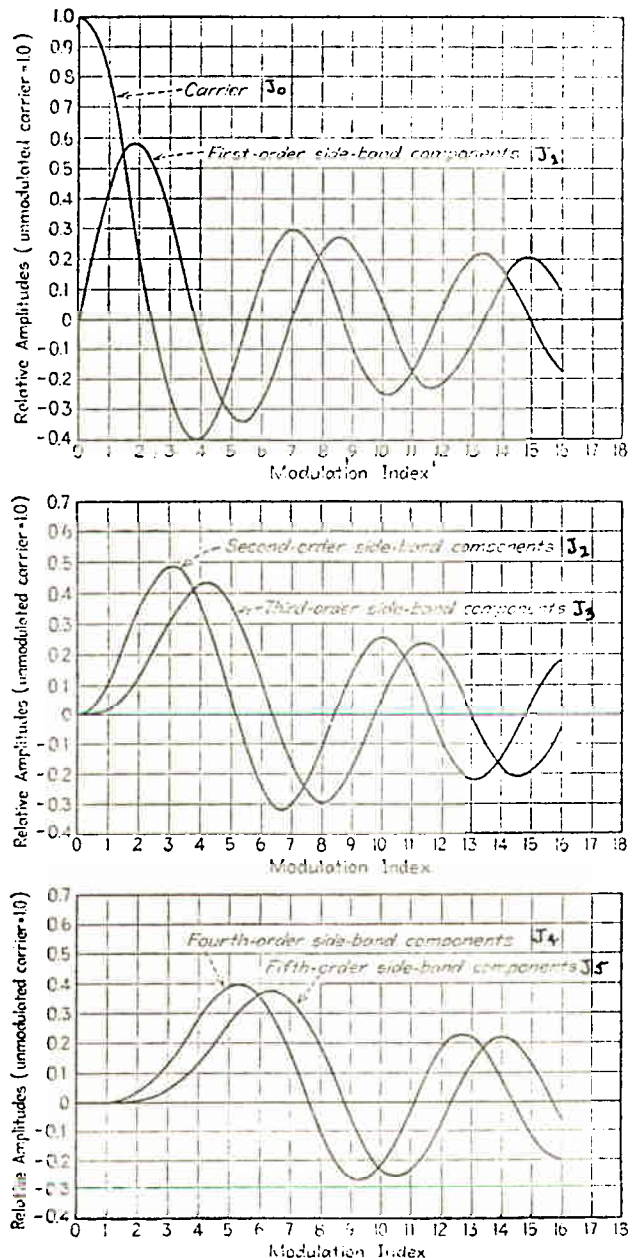

Fig. 2. Bessel functions which determine the amplitudes of the sideband components.

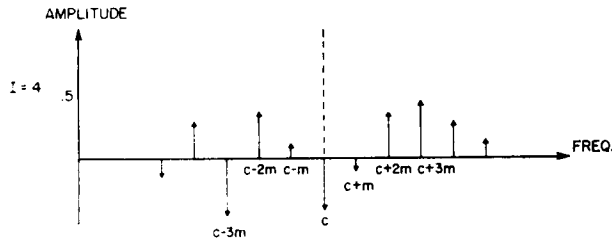

Fig. 3. Plot of Fig. 1e with phase information included (modulation index = 4). The bars extending downward represent spectral components whose phases differ by 180°.

All of the above relationships are expressed in the trigonometric expansion of Eq. [2]

$$e = A \left\{ \begin{aligned} &J_0(I) \sin at \\ &+ J_1(I) [\sin(a + \beta)t - \sin(a - \beta)] \\ &+ J_2(I) [\sin(a + 2\beta)t + \sin(a - 2\beta)] \\ &+ J_3(I) [\sin(a + 3\beta)t - \sin(a - 3\beta)] \\ &+ \dots \end{aligned} \right\}. \quad (2)$$

It can be seen in Eq. 2 that the odd-order lower-side frequencies,  $\sin(a-\beta)$ ,  $\sin(a-3\beta)$ , etc., are preceded by a negative sign, and that for an index greater than 2.5, the Bessel functions (Fig. 2) will yield a negative scaling coefficient for some components. Ordinarily, these negative signs are ignored in plotting spectra, as in Fig. 1, since they simply indicate a phase inversion of the frequency component,  $-\sin(\theta) = \sin(-\theta)$ . In the application of FM described below, this phase information is significant and must be considered in plotting spectra.

By way of demonstration, Fig. 1e is plotted, but with the phase information included, in Fig. 3. The carrier and the first upper-side frequency are plotted with a downward bar representing the phase inversion resulting from the negative Bessel coefficients. The importance in noting the phase inversions will be seen in the following section.

**REFLECTED SIDE FREQUENCIES**

The special richness of this FM technique lies in the fact that there are ratios of the carrier and modulating frequencies and values of the index which will produce sideband components that fall in the negative frequency domain of the spectrum. These negative components reflect around 0 Hz and "mix" with the components in the positive domain. The variety of frequency relations which result from this mix is vast and includes both harmonic and inharmonic spectra.

A simple but very useful example of reflected side frequencies occurs if the ratio of the carrier to modulating frequencies is unity. For the values

$$\begin{aligned} c &= 100 \text{ Hz} \\ m &= 100 \text{ Hz} \\ I &= 4 \end{aligned}$$

a plot of the spectrum is shown in Fig. 4a. The component at 0 Hz represents a constant in the wave. The remaining lower-side frequencies are reflected into the positive frequency domain with a change of sign (inversion of phase) and add algebraically to the components which are already there as shown in Fig. 4b. For example, the second lower-side frequency will add to the carrier with like signs, therefore increasing the energy at 100 Hz, while the third lower-side frequency

will add to the first upper-side frequency with unlike signs, decreasing the energy at 200 Hz. The spectrum, adjusted for the reflected frequency components and with the bars all up to reveal the spectral envelope, is shown in Fig. 4c.

**HARMONIC AND INHARMONIC SPECTRA**

The significance of the case above, where the ratio of the carrier to the modulating frequencies is 1/1, is that it is a member of the class of ratios of integers (rational numbers), thus

$$c/m = N_1/N_2$$

and  $N_1$  and  $N_2$  are integers. These ratios result in harmonic spectra. If in addition, all common factors have been divided out of  $N_1$  and  $N_2$ , then the fundamental frequency of the modulated wave will be

$$f_0 = c/N_1 = m/N_2.$$

The position of the side frequencies in the harmonic series can be determined from the following relations,

$$k = N_1 \pm nN_2 \quad \text{for } n = 0,1,2,3,4 \dots$$

where

$k$  = the harmonic number

and

$n$  = the order side frequency.

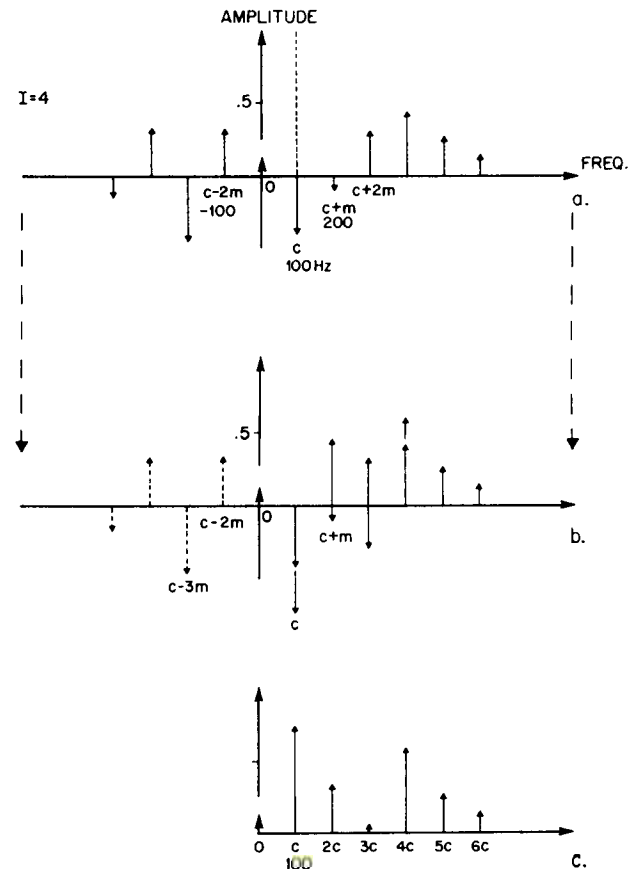

Fig. 4. Fig. 4a shows spectrum with components which lie in the negative frequency domain; b shows plot from a in which the frequencies in the negative domain are reflected around 0 Hz with an inversion of phase and added to the components in the positive domain; c is plot of the magnitude of the components of b.

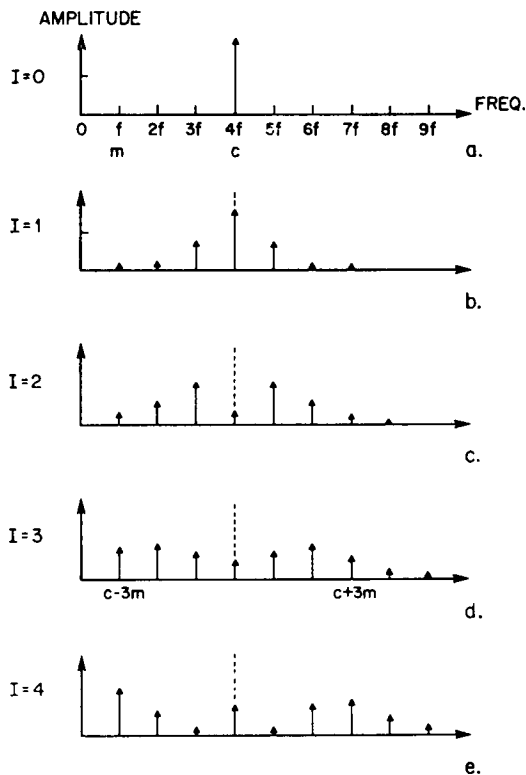

Fig. 5. Plot of spectrum where the ratio of  $c/m$  is  $4/1$ . As the index increases, the reflected lower side frequencies begin to affect the spectrum when  $I = 3$ , where the fundamental,  $c-3m$ , is noticeably greater than the 7th harmonic,  $c+3m$ . In e, the symmetry around the carrier is no longer apparent.

Except for  $n = 0$ , the carrier, there are two values for  $k$  for each order, corresponding to the upper and lower side frequencies.

Some useful generalizations can be made in regard to simple ratios.

- 1) The carrier is always the  $N_1$ th harmonic in the series.
- 2) If  $N_2 = 1$ , the spectrum contains all harmonics and the fundamental is at the modulating frequency, e.g.,  $1/1, 2/1$ .
- 3) When  $N_2$  is an even number, the spectrum contains only odd numbered harmonics, e.g.,  $1/2, 1/4, 3/2, 3/4, 5/2$ .
- 4) If  $N_2 = 3$ , every third harmonic is missing from the series, e.g.,  $1/3, 2/3, 4/3, 5/3$ .

As noted before, the actual number of harmonics which will have significant amplitude is dependent on the modu-

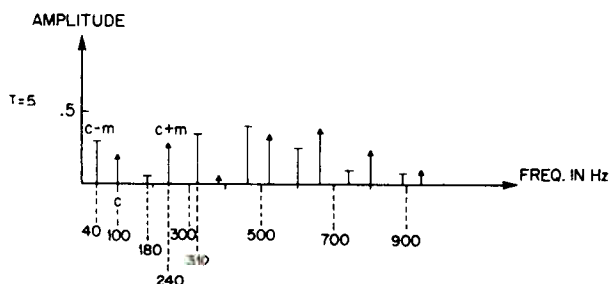

Fig. 6. Inharmonic spectrum where the ratio  $c/m \cong 1/\sqrt{2}$  and the modulation index  $= 5$ . The reflected components, represented here with the bar at the top, fall in between the other components.

lation index. For small indexes and ratios where  $N_1 \neq 1$ , the fundamental may not be present in the spectrum. This can be seen in the spectra plotted in Fig. 5, where the ratio  $c/m = 4/1$ . Adjusted for the reflected side frequencies, the spectra show the filling out of the harmonics with an increasing index. The fundamental only becomes significant when the index is greater than two.

Inharmonic spectra will result from ratios of irrational numbers, e.g.,  $c/m = 1/\sqrt{2}, \pi/\sqrt{3}, 1/e$ . In this case, the reflected side frequencies will fall between the positive components, thus forming a spectrum whose components are not in a relation of simple ratios. Fig. 6 shows an adjusted spectrum where the ratio  $c/m \cong 1/\sqrt{2}$  and the index  $= 5$ .

In summary, the ratio of the carrier and modulating frequencies ( $c/m$ ) determines the position of the components in the spectrum when there are reflected side frequencies, while the modulation index ( $d/m$ ) determines the number of components which will have significant amplitude.

### DYNAMIC SPECTRA

As demonstrated above, the equation for FM has an inherent and, as will be shown, most useful characteristic: the complexity of the spectrum is related to the modulation index in such a way that as the index increases, the bandwidth of the spectrum also increases (see Fig. 5). If, then, the modulation index were made to be a function of time, the evolution of the bandwidth of the spectrum could be generally described by the shape of the function. The evolution of each of the

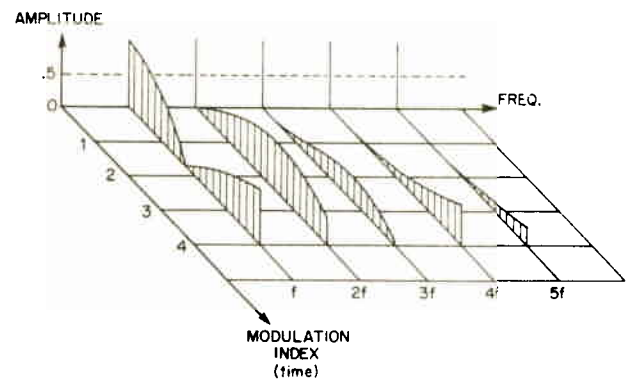

Fig. 7. Dynamic spectrum where the ratio  $c/m = 1/1$  and the modulation index increases from 0 to 4 continuously. The increasing bandwidth is easily seen, but because the spectrum includes the reflected side frequencies, the evolution of the individual components is not always intuitively clear.

components of the spectrum, however, is determined by the shape of the Bessel functions. Therefore, if the index increases with time the overall bandwidth will also increase, but a given component will either increase or decrease in amplitude depending on the slope of the Bessel function at that index range. Fig. 7 is a three-dimensional representation of a dynamic FM spectrum where  $c/m = 1/1$  and the modulation index increases in time from 0 to 4. If the index sweeps over a very large range, for example from 2 to 10, the amplitudes of the components will oscillate around 0 amplitude as the bandwidth of the spectrum increases.

The presence of reflected side frequencies in a dynamic spectrum enormously complicates the evolution



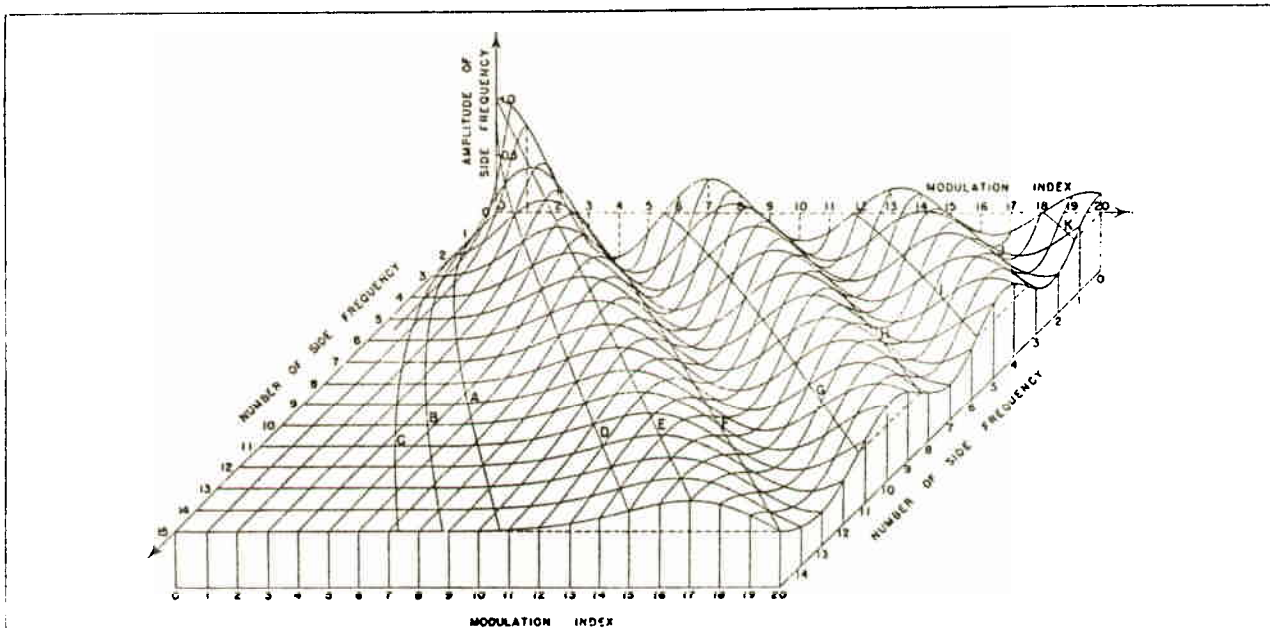

Fig. 8. Bessel functions,  $J_n$  through  $J_{15}$  and indexes 0 through 20. This representation allows a rapid determination of the bandwidth resulting from a given index.

of the individual components, to the extent that it is difficult to visualize the amplitude functions with any precision. It is possible to gain an intuitive feeling for their tendency of change, which in the research presented here, has proven to be largely sufficient.<sup>1</sup>

Certainly the complexity in the evolution of each of the components of the spectrum makes an important contribution to the lively quality of FM sounds. Because this complexity is a function of the laws of the equation, it is surprising that while the evolution of the components is rigidly determined, they can still produce such rich and varied subjective impressions.

In visualizing the effect of sweeping the modulation index, a careful study of Fig. 8 is helpful [3]. This is a three-dimensional representation of the orders  $J_0$  through  $J_{15}$  for an index range of 0 through 20 and is a sufficient range of orders and indexes for many useful dynamic spectra. Contour lines A, B, and C represent constant values of the functions at  $J_n(I) = .01, .001,$  and  $.0001$  respectively. Line A then, indicates which order side frequency is just significant at a given index. Line D represents the order of the function which is equal to the argument, or  $J_n(I)$  where  $n = I$ . This relation shows that any orders of side frequencies greater than the value of the index decrease rapidly in importance. Line E is the absolute maximum amplitude for each order. Lines F, G, H, I, J, and K show the zero crossings of the functions and, therefore, values of the index which will produce a null or zero amplitude for various orders of side frequencies.

**IMPLEMENTATION**

The research described here was done using a Digital Equipment Corporation PDP-10 computer for which

<sup>1</sup> A dynamic computer display program was very helpful in visualizing the spectra which result from a changing index and reflected side frequencies. Given a ratio of carrier to modulating frequencies and an initial and terminal index, the program plots the changing spectrum.

there is a special sound synthesis program designed to make optimum use of the time-sharing capability of the machine. Implementation of this research, however, will be described for MUSIC V, a sound synthesis program which is both well-documented and generally available [4].

MUSIC V is a program which generates samples or a numerical representation of a sound pressure wave according to data which specify the physical characteristics of the sound. The samples are stored on a memory device as they are computed. On completion of the computation, the samples are passed at a fixed rate (sampling rate, which is typically 10 000 to 30 000 samples/sec) to a digital-to-analog converter, which generates a sequence of voltage pulses whose amplitudes are proportional to the samples. The pulses are smoothed by a low-pass filter and passed to an audio system.

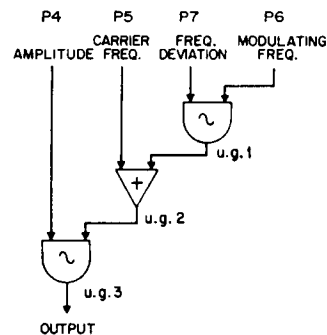

Fig. 9. Simple FM circuit as represented in MUSIC V notation.

The program is designed so that the computation of the samples is done by program blocks called unit generators. A typical unit generator is the oscillator which has two inputs, an output, and a stored waveshape function. The first input specifies the amplitude of the output, the second input the frequency of the output, and the function determines the shape of the output. The value of an input can either be specified by the

user or can be the output from another unit generator, thereby allowing multilevel operations on waveforms. A collection of interconnected unit generators is called an instrument, which is supplied data through a set of parameters,  $P_1$  to  $P_n$ , set by the user.  $P_1$  and  $P_3$  are reserved for beginning time and duration of the note the instrument is to play and  $P_2$  is reserved for the instrument number. The remaining parameters are assigned their function by the user.

Shown in Fig. 9, is an instrument diagram which consists of three unit generators, two oscillators and an adder. The function for each oscillator is defined to be a sinusoid. This instrument is capable of producing complex FM spectra such as the one in Fig. 4 where the values are now assigned to parameters.

$P_4 = 1000$  = amplitude of modulated carrier  
(arbitrary scaling)

$P_5 = 100$  Hz = carrier frequency

$P_6 = 100$  Hz = modulating frequency

$P_7 = 400$  Hz = frequency deviation, for  $l = 4$ .

Since  $l = d/m$ , then  $d = lm$  and for  $l = 4$  the peak deviation = 400 Hz. Oscillator 1 produces a sinusoidal output whose amplitude is scaled by  $P_7$  to be 400 Hz at a frequency of 100 Hz given by  $P_6$ .

In the case above, which is typical for this application of FM, the instantaneous frequency of the modulated carrier at times becomes negative. That is, from Eq. 1, the sum of  $at$ , a ramp function, and  $l \sin \beta t$ , a sinusoid with amplitude  $l$ , can produce a curve which has a negative slope at certain points and, therefore, a phase angle which *decreases* with time! This condition occurs when either the ratio of the carrier to the modulating frequency is very small or the modulation index is very large. The oscillator, u.g. 3, in Fig. 9 above, must be able to produce a wave which results from taking the sine of an angle which decreases as well as increases with time.<sup>2</sup>

In order to specify the modulation index as a function of time and control the attack and decay of the modulated carrier, it is necessary to alter the instrument, Fig. 9, by adding three more unit generators. In Fig. 10, u.g. 4 and u.g. 5 are time-domain function generators (oscillators or envelope generators in MUSIC V). U.g. 4 imposes an amplitude envelope on the modulated carrier and u.g. 5 and u.g. 6 together allow a dynamic control of the modulation index. The

<sup>2</sup> The change in code to the oscillator in MUSIC V to allow for a decreasing angle is:

for

```
290 IF(SUM-XNFUN) 288, 287, 287
287 SUM=SUM-XNFUN
```

substitute

```
290 IF(SUM.GE.XNFUN) GO TO 287
IF(SUM.LT. 0.0) GO TO 289
```

and for

```
GO TO 293
292 J6=L1+J3-1
```

substitute

```
GO TO 293
287 SUM=SUM-XNFUN
GO TO 288
289 SUM=SUM+XNFUN
GO TO 288
292 J6=L1+J3-1.
```

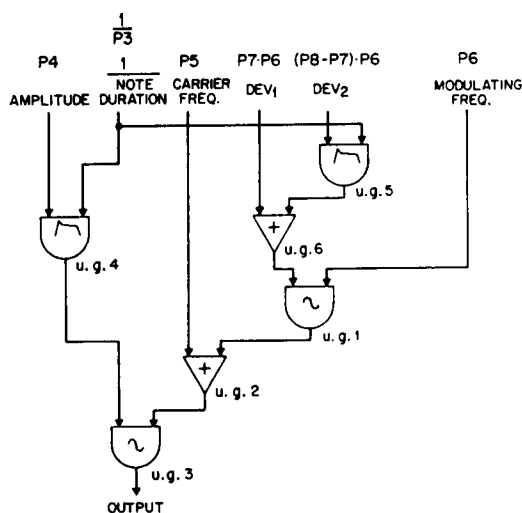

Fig. 10. FM circuit to produce dynamic spectra. Two function generators are added, u.g. 4 and u.g. 5, to produce an amplitude envelope and a modulation index envelope which causes the bandwidth to vary.

parameters for this instrument will have the following function:

- $P_1$  = Begin time of instrument
- $P_2$  = Instrument number
- $P_3$  = Duration of the "note"
- $P_4$  = Amplitude of the output wave
- $P_5$  = Carrier frequency
- $P_6$  = Modulating frequency
- $P_7$  = Modulation index 1,  $l_1$
- $P_8$  = Modulation index 2,  $l_2$

Since the bandwidth is related directly to the modulation index (and only indirectly to the deviation), a special routine can be used to produce the required deviation, deviation =  $P_7 \times P_6$  or deviation =  $(P_8 - P_7) \times P_6$ . The same routine can also generate the frequency inputs for u.g. 4 and u.g. 5, such that  $P_4 = 1/P_3$  where the relation  $1/\text{note-duration}$  causes the functions associated with these generators to be sampled at a rate so that one period is completed in the duration  $P_3$ . The oscillator and adder, u.g. 5 and u.g. 6, are related in such a way that  $P_7$  becomes the value of the modulation index when the output of u.g. 5 is zero and  $P_8$  is the modulation index when the output of u.g. 5 is one. For example, if Fig. 11 represents the function for the oscillator u.g. 5 and

```
P3 = .6 seconds
P6 = 100 Hz
P7 = 2
P8 = 8
```

first,  $P_7$  and  $P_8 - P_7$  are multiplied by  $P_6$  to convert to deviation, then the function is scaled by 600 and added to the constant input to the adder of 200. The output of the adder, then, is a deviation increasing from 200 to 800 in the first 1/6 seconds, decreasing from 800 to 650 in the next 1/6 seconds, etc. If the values of  $P_7$  and  $P_8$  are reversed, the function is inverted but between the same limits. Having this capability of scaling the deviation in direct or inverse proportion to the function and between any two values for  $l_1$  and  $l_2$  is useful in generating various dynamic spectra.

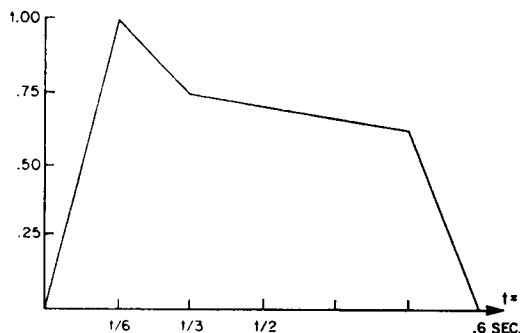

Fig. 11. Envelope function for brass-like tones.

## SIMULATIONS OF INSTRUMENT TONES

In this section, techniques for simulating three classes of instrument tones will be defined, using the computer instrument shown in Fig. 10.

### Brass-like Tones

Risset demonstrated in his revealing analysis of trumpet tones [5] a fundamental characteristic of this class of timbres; the amount of energy in the spectrum is distributed over an increasing band in approximate proportion to the increase of intensity. A simulation of this class of timbres is developed around the following premises:

- 1) The frequencies in the spectrum are in the harmonic series,
- 2) Both odd and even numbered harmonics are at some times present,
- 3) The higher harmonics increase in significance with intensity,
- 4) The rise-time of the amplitude is rapid for a typical attack and may "overshoot" the steady state.

Oscillators, u.g. 4 and u.g. 5, in Fig. 10, control the amplitude and modulation index (deviation indirectly), and both use the time domain function shown in Fig. 11. The parameter values for a brass-like tone can be:

$$\begin{aligned} P_3 &= .6 \\ P_4 &= 1000 \text{ (amplitude scaling)} \\ P_5 &= 440 \text{ Hz} \\ P_6 &= 440 \text{ Hz (ratio of } c/m = 1/1) \\ P_7 &= 0 \\ P_8 &= 5. \end{aligned}$$

The modulation index (therefore deviation) changes in direct proportion to the amplitude of the modulated carrier wave; the result being an increase or decrease in significance of the side frequencies in proportion to the amplitude envelope function. The ratio,  $c/m = 1/1$ , produces components that fall in the harmonic series. By changing the values of the indexes by small amounts and the shape of the function, a large number of variations can be achieved.

### Woodwind-like Tones

It is sometimes the case with woodwinds and organ pipes that the first frequencies to become prominent during the attack are the higher harmonics, which then decrease in prominence as the lower harmonics increase during the steady state. This type of spectral evolution

can be achieved in several ways, for example, by setting the carrier frequency to be an integral multiple of the modulating frequency, or by making the index function inversely proportional to the amplitude function. A simulation of this class of timbres is developed around the following premises:

- 1) The frequencies in the spectrum are in the harmonic series and for some woodwind tones are predominantly odd numbered harmonics,
- 2) The higher harmonics may decrease in significance with the attack.

In the first example, the carrier frequency is three times the modulating frequency, or  $c/m = 3/1$ , and the amplitude and index function is shown in Fig. 12. Since during the attack the index increases from 0 to 2, the carrier (3rd harmonic) will be apparent at the onset of the tone and then quickly decrease as the side frequencies fill out the spectrum. The parameters are:

$$\begin{aligned} P_5 &= 900 \text{ Hz} \\ P_6 &= 300 \text{ Hz} \\ P_7 &= 0 \\ P_8 &= 2. \end{aligned}$$

A ratio of  $c/m = 5/1$  will produce a bassoon-like timbre in the lower octaves. The functions remain as above and the parameters are:

$$\begin{aligned} P_5 &= 500 \text{ Hz} \\ P_6 &= 100 \text{ Hz} \\ P_7 &= 0 \\ P_8 &= 1.5. \end{aligned}$$

Another reed quality can be produced by choosing a ratio of  $c/m$  which yields the odd harmonics. The parameters

$$\begin{aligned} P_5 &= 900 \text{ Hz} \\ P_6 &= 600 \text{ Hz} \\ P_7 &= 4 \\ P_8 &= 2 \end{aligned}$$

will produce a clarinet-like timbre where 300 Hz is the fundamental and the index is inversely proportional to the amplitude function. The bandwidth of the spectrum will decrease as the amplitude increases during the attack.

In all of the above examples, small alterations can be made which make the sounds more interesting and/or realistic. A particularly useful alteration is the addition of a small constant to the modulating frequency. If the value .5 Hz were added, for example, the reflected lower-side frequencies would not fall exactly on the upper-side frequencies, producing a beat frequency or tremulant of 1 c/s. The realism can be further improved by making the function controlling the index the same as the amplitude function only through the attack and steady state and, thereafter, remaining constant. If Fig. 12 is the shape of the amplitude function, then Fig. 13 would be the shape of the index function. The evolution of the



Fig. 12. Envelope function for woodwind-like tones.

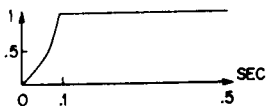

Fig. 13. Special envelope function for modulation index to achieve a better approximation to a woodwind timbre.

spectrum during the attack is apparently not always reversed during the decay.

### Percussive Sounds

A general characteristic of percussive sounds is that the decay shape of the envelope is roughly exponential as shown in Fig. 14. A simulation of this class of timbres would be developed around the premises:

- 1) The spectral components are not usually in the harmonic series,
- 2) The evolution of the spectrum is from the complex to the simple.

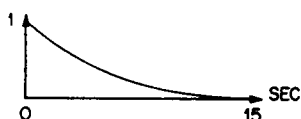

Fig. 14. Exponential decaying envelope for bell-like timbres.

Bell-like sounds can be produced by making the change of the index directly proportional to the amplitude envelope. Fig. 14, then, is the function for the amplitude and index. The parameters can be the following:

$$\begin{aligned}
 P_3 &= 15 \text{ seconds} \\
 P_4 &= 1000 \\
 P_5 &= 200 \text{ Hz} \\
 P_6 &= 280 \text{ Hz} \\
 P_7 &= 0 \\
 P_8 &= 10.
 \end{aligned}$$

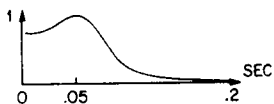

Fig. 15. Modification of exponential envelope to obtain drum-like sound.

The ratio  $c/m = 1/1.4$  results in an inharmonic relation of the frequency components. With the large initial index, the spectrum is dense and as the amplitude decreases the spectrum becomes gradually simple. As the amplitude approaches 0, the predominant frequency is the carrier at 200 Hz. By changing the amplitude function to that shown in Fig. 15, and with the following parameters, a drum-like sound can be produced.

$$\begin{aligned}
 P_3 &= .2 \\
 P_5 &= 200 \text{ Hz} \\
 P_6 &= 280 \text{ Hz} \\
 P_7 &= 0 \\
 P_8 &= 2.
 \end{aligned}$$

The principal difference from the bell sound, in addition to the short duration, is the vastly reduced initial bandwidth of the spectrum.

A wood drum sound is produced by keeping the pre-

vious amplitude function, but modulating the index according to the function shown in Fig. 16. The parameters are:

$$\begin{aligned}
 P_3 &= .2 \\
 P_5 &= 80 \text{ Hz} \\
 P_6 &= 55 \text{ Hz} \\
 P_7 &= 0 \\
 P_8 &= 25.
 \end{aligned}$$

The change of the index causes a burst of energy distributed over a wide frequency band at the onset, followed by rapid decrease of the bandwidth to a sinusoid which has the perceptual effect of a strong resonance. It should be noted that a complex amplitude modulation also occurs in this case. Because the Bessel functions are quasi-periodic around 0, the components undergo an asynchronous modulation due to the rapid sweep of the index over the wide range.



Fig. 16. Envelope for wood-drum sound.

The above examples are intended to give some feeling for the power and economy of means in FM synthesis, although they by no means exhaust the potential of this instrument. With an additional five unit generators, as shown in Fig. 17, further control can be gained over the spectrum. U.g. 10 provides another carrier wave, but uses the same modulating oscillator. The frequency deviation (proportional to the index) can be scaled up or down by the multiplier, u.g. 8. Since the second-carrier frequency,  $P_{12}$ , is independent, it can be set to be a multiple of the first-carrier frequency and therefore add components in another region of the spectrum. The proportion of the two modulated carriers is determined by the multiplier, u.g. 7, which scales the amplitude before it is applied to the second carrier. The outputs are mixed by the adder, u.g. 11. With the parameters

$$\begin{aligned}
 P_5 &= 300 \text{ Hz} \\
 P_6 &= 300 \text{ Hz} \\
 P_7 &= 1 \\
 P_8 &= 3 \\
 P_{10} &= .2 \\
 P_{11} &= .5 \\
 P_{12} &= 2100 \text{ Hz}
 \end{aligned}$$

the second carrier will add components centered around the 7th harmonic ( $c_2/m = 7/1$ ), where the index ranges between .5 and 1.5 and at an amplitude ratio of 5/1. The effect is that of a formant region added to the spectrum.

### CONCLUSION

The technique of FM synthesis provided a very simple temporal control over the bandwidth of spectra whose component frequencies can have a variety of relationships. Because "nature" is doing most of the "work," the technique is far simpler than additive or subtractive synthesis techniques which can produce similar spectra. Perhaps the most surprising aspect of the FM technique, is that the seemingly limited control imposed by "nature"



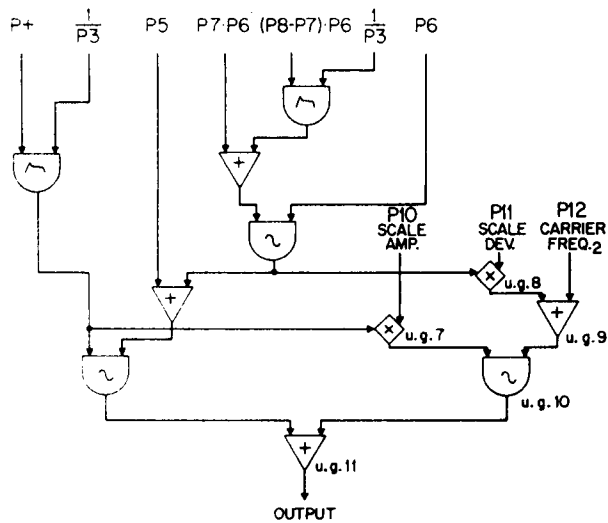

Fig. 17. FM circuit which allows greater control over the spectrum. The additional carrier wave uses the same modulating wave but the deviation can be scaled up or down by the multiplier. A formant peak can be placed at an arbitrary point in the spectrum.

over the evolution of the individual spectral components, proves to be no limitation at all as far as subjective impression is concerned. This suggests that the precise amplitude curve for each frequency component in a complex dynamic spectrum is not nearly as important, perceptually, as the general character of evolution of the components as a group.

A full understanding of, and comprehensive applica-

tion of the FM technique will certainly take a number of years. The applications are surely more numerous in the unknown timbral space than they are in the known. There is, however, great informative value in first limiting oneself to the simulation of natural timbres since we have such well-formed perceptual images against which one can measure success. What can be learned in this process are those subtle attributes of natural spectra which so distinctively separate them from most synthesized spectra and which can then be applied to the unknown, "composed" timbral space with the result of a vastly enriched domain in which the composer can work.

**ACKNOWLEDGMENTS**

The author wishes to express his appreciation to George Gucker for the initial insight into reflected side frequencies and to Max Mathews, David Poole, Gary Goodman, Martin Bresnick, John Gray, Loren Rush, and Andy Moorer for their help in this research.

**REFERENCES**

- [1] Jean-Claude Risset and Max V. Mathews, "Analysis of Musical Instrument Tones," *Physics Today*, vol. 22, no. 2, pp. 23-30 (1969).
- [2] Frederick E. Terman, *Radio Engineering*, pp. 483-489 (McGraw-Hill, New York, 1947).
- [3] Murlan S. Corrington, "Variation of Bandwidth with Modulation Index in Frequency Modulation," *Selected Papers on Frequency Modulation*, edited by Klapper (Dover Publications, 1970).
- [4] Max V. Mathews, *The Technology of Computer Music* (The MIT Press, Boston, 1969).
- [5] Jean-Claude Risset, *op. cit.*

**THE AUTHOR**



John M. Chowning was born in Salem, N.J., in 1934. He received the B.Mus. degree in composition from Wittenberg University in 1959 after military service. He studied composition in Paris for three years with Nadia Boulanger. In 1966, he received the doctorate in composition from Stanford University, where he

studied with Leland Smith. With the help of Max Mathews of Bell Telephone Laboratories, in 1964 he set up a computer music program at Stanford. Dr. Chowning currently teaches music theory and computer-sound synthesis and composition at Stanford's Department of Music.