

Signal Processing First

Lecture 20 Convolution (Continuous-Time)

11/3/2003

© 2003, JH McClellan & RW Schafer

1

READING ASSIGNMENTS

- This Lecture:
 - Chapter 9, Sects. 9-6, 9-7, and 9-8
- Other Reading:
 - Recitation: Ch. 9, all
 - Next Lecture: Start reading Chapter 10

11/3/2003

© 2003, JH McClellan & RW Schafer

3

LECTURE OBJECTIVES

- Review of C-T LTI systems
- **Evaluating convolutions**
 - **Examples**
 - **Impulses**
- LTI Systems
 - Stability and causality
 - Cascade and parallel connections

Linear and Time-Invariant (LTI) Systems

- If a continuous-time system is both linear and time-invariant, then the output $y(t)$ is related to the input $x(t)$ by a **convolution integral**

$$y(t) = \int_{-\infty}^{\infty} x(\tau)h(t-\tau)d\tau = x(t) * h(t)$$

where $h(t)$ is the **impulse response** of the system.

11/3/2003

© 2003, JH McClellan & RW Schafer

4

11/3/2003

© 2003, JH McClellan & RW Schafer

5

Testing for Linearity

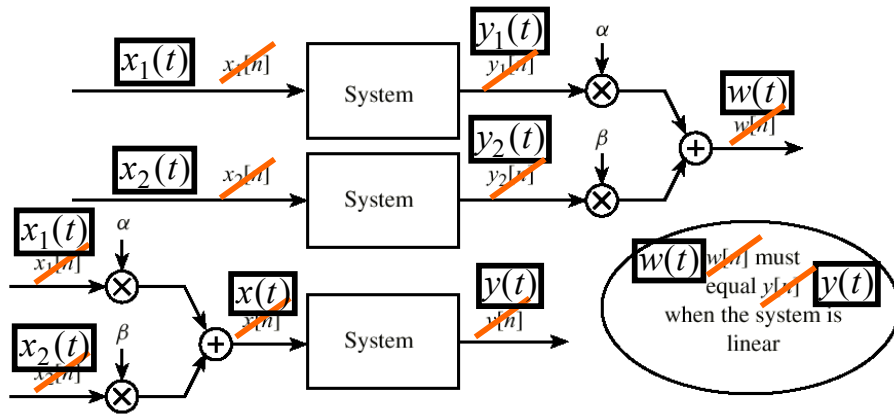

11/3/2003

© 2003, JH McClellan & RW Schaffer

6

Testing Time-Invariance

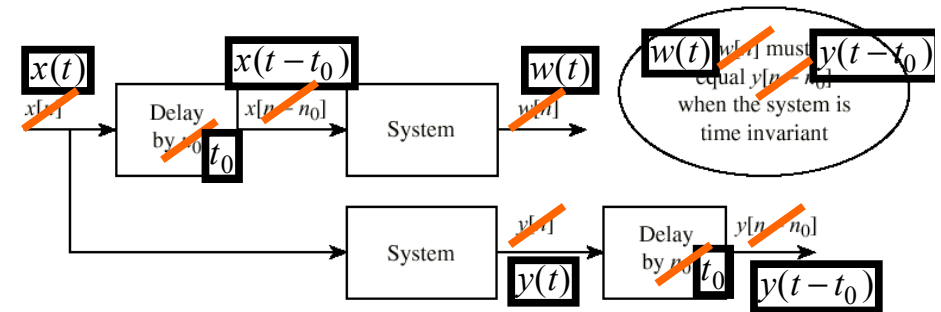

11/3/2003

© 2003, JH McClellan & RW Schaffer

7

Ideal Delay: $y(t) = x(t - t_d)$

- Linear

$$ax_1(t - t_d) + bx_2(t - t_d) = ay_1(t) + by_2(t)$$

- and Time-Invariant

$$w(t) = x((t - t_d) - t_0)$$

$$y(t - t_0) = x((t - t_0) - t_d)$$

11/3/2003

© 2003, JH McClellan & RW Schaffer

8

Integrator: $y(t) = \int_{-\infty}^t x(\tau) d\tau$

- Linear

$$\begin{aligned} \int_{-\infty}^t [ax_1(\tau) + bx_2(\tau)] d\tau &= \int_{-\infty}^t ax_1(\tau) d\tau + \int_{-\infty}^t bx_2(\tau) d\tau \\ &= ay_1(t) + by_2(t) \end{aligned}$$

- And Time-Invariant

$$w(t) = \int_{-\infty}^t x(\tau - t_0) d\tau \quad \text{Let } \sigma = \tau - t_0$$

$$\Rightarrow w(t) = \int_{-\infty}^{t-t_0} x(\sigma) d\sigma = y(t - t_0)$$

11/3/2003

9

Modulator: $y(t) = [A + x(t)] \cos \omega_c t$

- **Not** linear--obvious because

$$[A + ax_1(t) + bx_2(t)] \neq [A + ax_1(t)] + [A + bx_2(t)]$$

- **Not** time-invariant

$$w(t) = [A + x(t - t_0)] \cos \omega_c t \neq y(t - t_0)$$



Linear and Time-Invariant (LTI) Systems

- If a continuous-time system is both linear and time-invariant, then the output $y(t)$ is related to the input $x(t)$ by a **convolution integral**

$$y(t) = \int_{-\infty}^{\infty} x(\tau)h(t - \tau)d\tau = x(t) * h(t)$$

where $h(t)$ is the **impulse response** of the system.

Convolution of Impulses, etc.

- Convolution of two impulses

$$\delta(t - t_1) * \delta(t - t_2) = \delta(t - t_1 - t_2)$$

- Convolution of step and shifted impulse

$$u(t) * \delta(t - t_0) = u(t - t_0)$$

Evaluating a Convolution

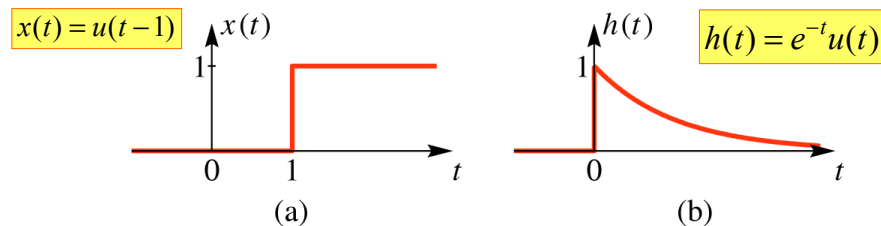

$$y(t) = \int_{-\infty}^{\infty} h(\tau)x(t - \tau)d\tau = h(t) * x(t)$$

“Flipping and Shifting”

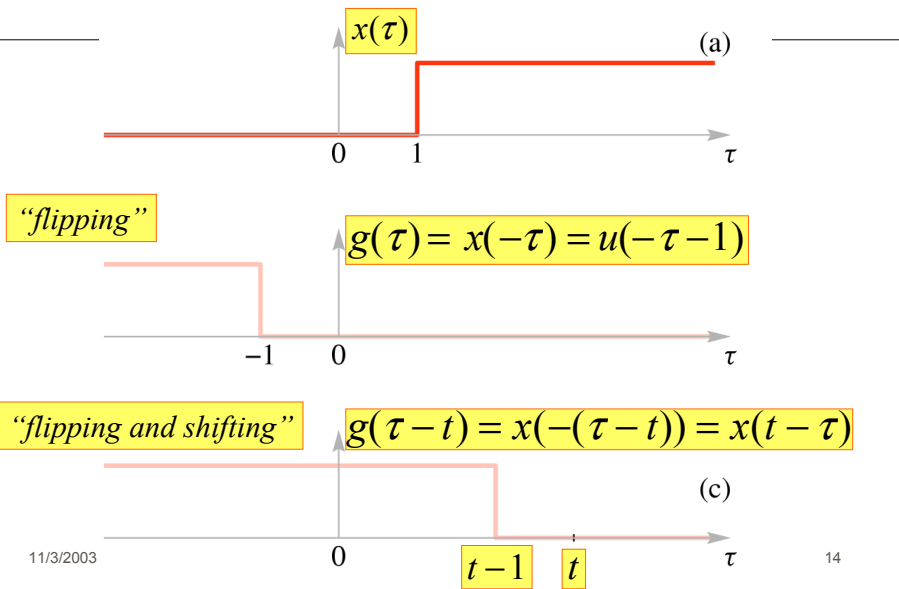

Evaluating the Integral

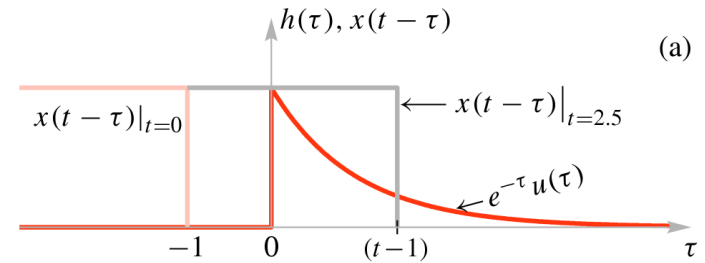

$$y(t) = \begin{cases} 0 & t-1 < 0 \\ \int_0^{t-1} e^{-\tau} d\tau & t-1 > 0 \end{cases}$$

11/3/2003

15

Solution

$$y(t) = \int_0^{t-1} e^{-\tau} d\tau = -e^{-\tau} \Big|_0^{t-1} = 1 - e^{-(t-1)} \quad t \geq 1$$

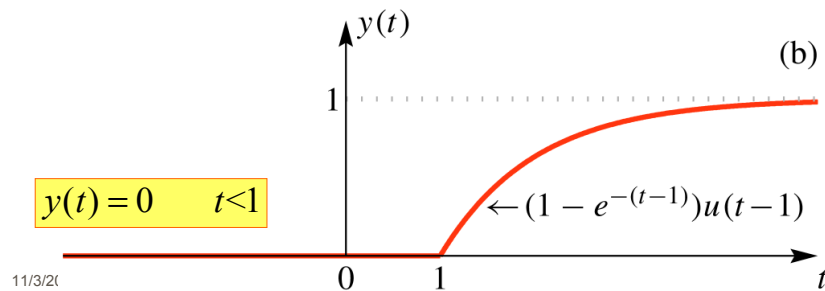

Convolution GUI

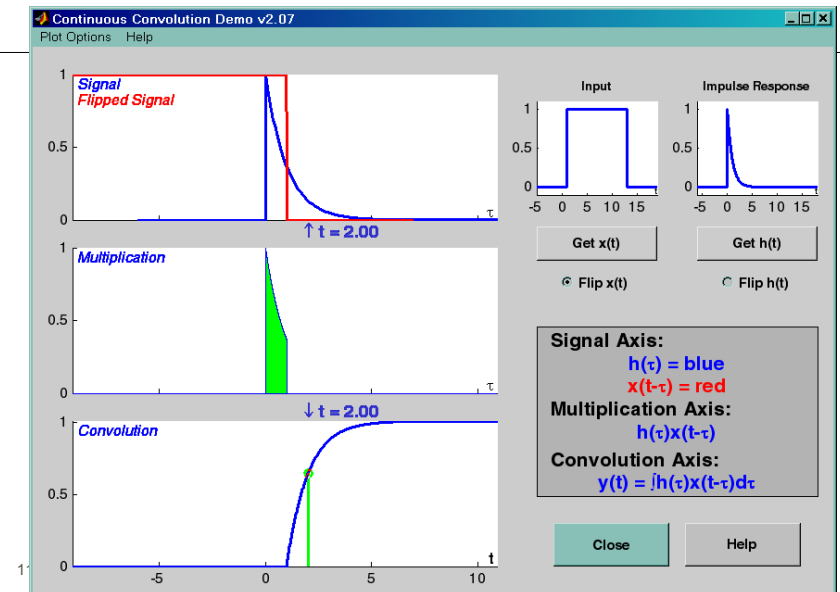

General Convolution Example

$$x(t) = e^{-at}u(t)$$

$$h(t) = e^{-bt}u(t), \quad b \neq a$$

$$\begin{aligned}
 y(t) &= \int_{-\infty}^{\infty} x(\tau)h(t-\tau)d\tau = x(t) * h(t) \\
 &= \int_{-\infty}^{\infty} e^{-a\tau}u(\tau)e^{-b(t-\tau)}u(t-\tau)d\tau = \begin{cases} e^{-bt} \int_0^t e^{-a\tau}e^{b\tau}d\tau & t > 0 \\ 0 & t < 0 \end{cases} \\
 &= \begin{cases} \frac{e^{-at} - e^{-bt}}{-a+b} & t > 0 \\ 0 & t < 0 \end{cases} = \frac{e^{-at} - e^{-bt}}{b-a}u(t)
 \end{aligned}$$

11/3

Special Case: $u(t)$

$$x(t) = e^{-at}u(t), \quad a \neq 0$$

$$h(t) = u(t)$$

$$\begin{aligned}
 y(t) &= \int_{-\infty}^{\infty} x(\tau)h(t-\tau)d\tau = x(t) * h(t) \\
 &= \frac{1}{a}(1 - e^{-at})u(t)
 \end{aligned}$$

if $a = 2$

$$y(t) = \frac{1}{2}(1 - e^{-2t})u(t)$$

11/3

V Schafer

19

Convolve Unit Steps

$$x(t) = u(t)$$

$$h(t) = u(t)$$

$$\begin{aligned}
 y(t) &= \int_{-\infty}^{\infty} x(\tau)h(t-\tau)d\tau = x(t) * h(t) \\
 &= \int_{-\infty}^{\infty} u(\tau)u(t-\tau)d\tau = \begin{cases} \int_0^t 1d\tau & t > 0 \\ 0 & t < 0 \end{cases} \\
 &= \begin{cases} t & t > 0 \\ 0 & t < 0 \end{cases} = tu(t) \quad \text{Unit Ramp}
 \end{aligned}$$

11/3/

20

Convolution is Commutative

$$\begin{aligned}
 h(t) * x(t) &= \int_{-\infty}^{\infty} h(\tau)x(t-\tau)d\tau \\
 &\quad \text{let } \sigma = t - \tau \text{ and } d\sigma = -d\tau \\
 h(t) * x(t) &= - \int_{-\infty}^{\infty} h(t-\sigma)x(\sigma)d\sigma \\
 &= \int_{-\infty}^{\infty} h(t-\sigma)x(\sigma)d\sigma = x(t) * h(t)
 \end{aligned}$$

11/3/2003

© 2003, JH McClellan & RW Schafer

21

Cascade of LTI Systems

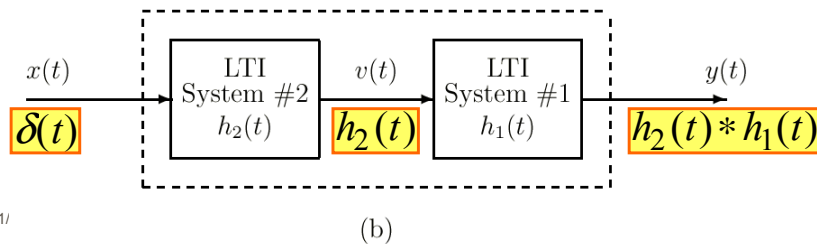
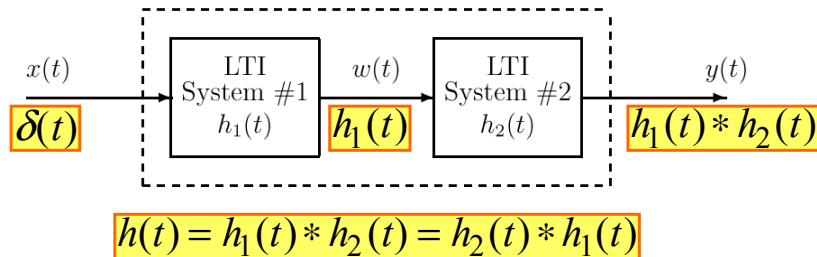

11/

(b)

Stability

- A system is stable if every bounded input produces a bounded output.
- A continuous-time *LTI system* is stable if and only if

$$\int_{-\infty}^{\infty} |h(t)| dt < \infty$$

11/3/2003

© 2003, JH McClellan & RW Schafer

23

Causal Systems

- A system is causal if and only if $y(t_0)$ depends only on $x(\tau)$ for $\tau \leq t_0$.
- An LTI system is causal if and only if

$$h(t) = 0 \text{ for } t < 0$$

Convolution is Linear

- Substitute $x(t) = ax_1(t) + bx_2(t)$

$$\begin{aligned}
 y(t) &= \int_{-\infty}^{\infty} [ax_1(\tau) + bx_2(\tau)]h(t - \tau)d\tau \\
 &= a \int_{-\infty}^{\infty} x_1(\tau)h(t - \tau)d\tau + b \int_{-\infty}^{\infty} x_2(\tau)h(t - \tau)d\tau \\
 &= ay_1(t) + by_2(t)
 \end{aligned}$$

Therefore, convolution is linear.

11/3/2003

© 2003, JH McClellan & RW Schafer

24

11/3/2003

© 2003, JH McClellan & RW Schafer

25

Convolution is Time-Invariant

- Substitute $x(t-t_o)$

$$\begin{aligned}w(t) &= \int_{-\infty}^{\infty} h(\tau)x((t-\tau)-t_o)d\tau \\ &= \int_{-\infty}^{\infty} h(\tau)x((t-t_o)-\tau)d\tau \\ &= y(t-t_o)\end{aligned}$$