

**Comparison of Beam Selection and Antenna  
Selection Techniques in Indoor MIMO Systems  
at 5.8 GHz**

by

Jeng-Shiann Jiang and Mary Ann Ingram

{jsjiang@ece.gatech.edu, mai@ece.gatech.edu}

School of Electrical and Computer Engineering  
Georgia Institute of Technology

Copyright © 2003 IEEE. Reprinted from the IEEE Radio and Wireless Conference, Aug. 2003. This material is posted here with permission of the IEEE. Internal or personal use of this material is permitted. However, permission to reprint/republish this material for advertising or promotional purposes or for creating new collective works for resale or redistribution must be obtained from the IEEE by sending a blank email message to [pubs-permissions@ieee.org](mailto:pubs-permissions@ieee.org). By choosing to view this document, you agree to all provisions of the copyright laws protecting it.

# Comparison of Beam Selection and Antenna Selection Techniques in Indoor MIMO Systems at 5.8 GHz

Jeng-Shiann Jiang and Mary Ann Ingram

School of Electrical and Computer Engineering, Georgia Institute of Technology, Atlanta, GA 30332-0250, USA  
gte345k@prism.gatech.edu and mai@ece.gatech.edu

**Abstract** – The comparison of beam selection and antenna selection techniques in conjunction with the multiple-input-multiple-output (MIMO) architecture is provided for measured channels. The channels, captured on a 3D MIMO measurement system based on the virtual antenna array technology, are centered at 5.8 GHz with a frequency span of 500 MHz. Both flat- and frequency-selective fading are considered. The selection techniques can be applied to either the transmit end or both ends of the communication links, and both cases are considered. Shannon capacity is employed as the comparison criterion throughout the paper. The presence of the line-of-sight (LOS), and the correlation of interference are shown to impact the performances of both kinds of selection techniques. The use of beams does not eliminate the need for stream control, which is the regulation of the number of data streams when MIMO links interfere. The results show that in the indoor environment, the beam selection is only slightly better than the antenna selection in both narrowband and wideband channels when stream control is used. However, without stream control, beam selection offers a significant improvement over antenna selection.

**Keywords** – MIMO, beam selection, antenna selection, MIMO channel measurement, virtual antenna array.

## I. INTRODUCTION

Multiple-input-multiple-output (MIMO) or spatially multiplexed wireless links have received a great deal of recent attention because they can provide extremely high spectral efficiencies in rich multipath environments [1]. For a given number of transmit/receive modules, the MIMO channel can be improved by selecting the MIMO antenna elements from among a larger set of elements at one or both ends of a link [2,3], thereby providing some spatial diversity. The price for antenna selection is the cost and the insertion loss of the switch [4]. The MIMO performance may be further improved by using an RF multi-beam beamformer (MBBF) in combination with the switch. The MBBF, an older technology with simple implementations like the Butler matrix [5], has drawn significant attention in the arena of cellular systems because of its interference suppression and space division multiple access (SDMA) capabilities. The MBBF also has an insertion loss, however its complexity and cost is significantly less than the switch [6]. The MBBF benefits observed in simulation studies [7] and the small add-on cost of the MBBF are what led us to consider the comparison between antenna selection and beam selection.

This research was supported in part by the National Science Foundation under Grant No. CCR-0121565.

As shown in Figure 1, a MIMO link with antenna selection can be changed into a MIMO link with beam selection by simply inserting a MBBF (like a Butler matrix) between the antennas and the switch. One might think beam selection should be better than antenna selection in a frequency selective channel because path angles, and therefore best beams, are not very sensitive to frequency, while small scale fading effects, and therefore the best antennas, are sensitive to frequency. However, we observe only a small difference between their performances in the indoor environment unless the receive arrays are overwhelmed by too many streams. This conclusion is based on a few indoor measurements that differ in terms of the existence of line of sight (LOS), the channel bandwidth, the presence of interference, and the correlation between the intended signal and interference.

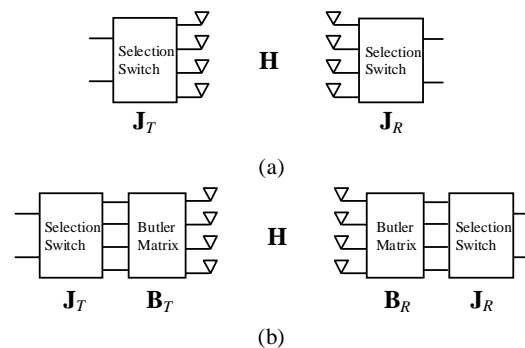

Figure 1: (a) Antenna Selection. (b) Beam Selection.

This paper is organized as follows. Section II provides brief description of our MIMO channel measurement system and the experiment environment. In Section III, we compare the performances of beam and antenna selection in narrowband channels in terms of ergodic Shannon capacity. Section IV is devoted to the exploration of their throughput in the wideband channel. Section V concludes the findings.

## II. MIMO MEASUREMENT SYSTEM AND THE MEASUREMENT ENVIRONMENT

The channel measurements were conducted with our 3D MIMO measurement system [8] in the Residential Laboratory at the Georgia Institute of Technology. The measurement system, which can acquire the MIMO channel matrix, is based on the virtual antenna array technique, and its high repeatability has been validated by some previous experiments [9]. As shown in Figure 2, there are two receive array (Rx) locations and eight transmit array (Tx) locations. The Tx and Rx are both at a height of approximately 1.35m. The transmitter was a virtual 16-

element (4×4) square array, and the receiver was a virtual 4-element uniform linear array. The antenna spacing of both arrays is  $0.5\lambda$  where  $\lambda$  is the wavelength of 5.8 GHz signal. The number of frequency samples, 51, is chosen such that the separation between adjacent samples (10 MHz) is large enough to obtain independent realizations of the flat-fading channels. As a consequence, we extracted totally  $4 \times 51 = 204$  realizations of (4,4) flat fading and four wideband channel matrices for each Tx-Rx link.

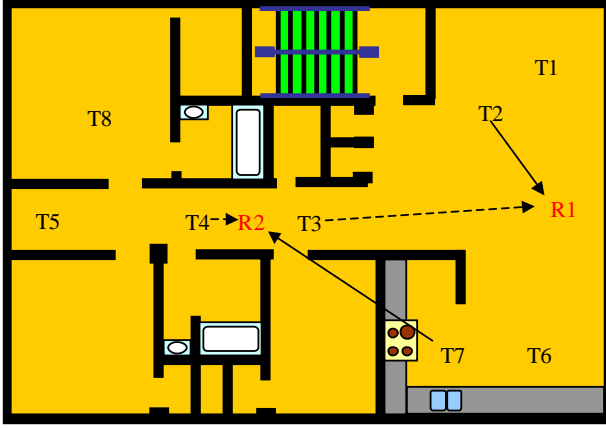

Figure 2: Layout of Residential Laboratory (RL)

### III. NARROWBAND MIMO CHANNELS

Our notation is as follows:  $N_T$  and  $N_R$  denote the numbers of transmit and receive antennas, respectively.  $n_T$  and  $n_R$  stand for the numbers of selected transmit and receive antennas, respectively. The measured channel matrix, denoted as  $\mathbf{H}$ , is an  $N_R \times N_T$  matrix, which is noise-normalized before being further employed by the beam and antenna selection method. The MIMO channel matrices after antenna selection and beam selection are given by

$$\mathbf{H}_{ant} = \mathbf{J}_R \mathbf{H} \mathbf{J}_T^\dagger, \text{ and} \quad (1)$$

$$\mathbf{H}_{beam} = \mathbf{J}_R \mathbf{B}_R \mathbf{H} \mathbf{B}_T^\dagger \mathbf{J}_T^\dagger, \quad (2)$$

respectively, where the component matrices are indicated in Figure 1, and explained as follows.  $\mathbf{J}_R \in \mathbf{R}_{n_R \times N_R}$  and  $\mathbf{J}_T \in \mathbf{R}_{n_T \times N_T}$  are the lossless selection matrices at both ends,  $\mathbf{B}_R = [\mathbf{B}_R^1 \ \mathbf{B}_R^2 \ \dots \ \mathbf{B}_R^{N_R}]$  and  $\mathbf{B}_T^\dagger = [\mathbf{B}_T^1 \ \mathbf{B}_T^2 \ \dots \ \mathbf{B}_T^{N_T}] \in \mathbf{C}_{N_R \times N_T}$  are the lossless receive and transmit Butler matrices. The  $m^{\text{th}}$  columns of  $\mathbf{B}_R$  and  $\mathbf{B}_T^\dagger$  are

$$\mathbf{B}_R^m(n) = \frac{1}{\sqrt{N_R}} e^{\frac{j\pi(m-1)[-(N_R-1)+2(n-1)]}{N_R}}, \quad n = 1 \dots N_R \quad (3)$$

$$\mathbf{B}_T^m(n) = \frac{1}{\sqrt{N_T}} e^{\frac{-j\pi(n-1)[-(N_T-1)+2(m-1)]}{N_T}}, \quad n = 1 \dots N_T \quad (4)$$

In this paper we consider only open-loop MIMO, which means the channel information is not fed back to the transmitter and the power is evenly allocated to each transmit antenna. With this assumption, the capacity of the

channel without interference is calculated according to the following equation [1].

$$C = \log_2 \left| \mathbf{I} + \frac{\rho}{n_T} \mathbf{H} \mathbf{H}^\dagger \right|, \quad (5)$$

where  $\rho$  is the signal-to-noise ratio (SNR). For the channels with interference, suppose the correlation matrix of the interference is  $\mathbf{R}_{int}$ , the capacity is calculated as follows [10]:

$$C_{int} = \log_2 \left| \mathbf{I} + \frac{\rho}{n_T} \tilde{\mathbf{H}} \tilde{\mathbf{H}}^\dagger \right|, \quad (6)$$

$$\text{where } \tilde{\mathbf{H}} = (\mathbf{I} + \mathbf{R}_{int})^{-1/2} \mathbf{H}.$$

The beams or antennas are selected to maximize the capacity.

#### A. No Interference

As shown in Figure 3, Link T2-R1 is the channel with LOS. Provided no interferences from other users are present, the measured performances are depicted in Figure 3. The label ‘‘All Antennas,’’ indicates the condition when all four antennas are employed. Its results are used as a reference. The ‘‘No selection’’ curve is the performance of the system when the first  $n_T$  or  $n_R$  antennas are used at transmit and receive ends. In Figure 3(a), the selection is only applied at the transmit end, which implies  $\mathbf{H}_{ant}$  and  $\mathbf{H}_{beam}$  are  $4 \times 2$  matrices. First, we observe that ‘‘All antennas’’ has the best performance in high SNR range because its rank is larger than the others. At 14 bits/s/Hz, beam selection outperforms antenna selection and no selection by 1.5 and 4 dB, respectively. In Figure 3(b), in which the selection is executed at both ends, the performance order of these four methods still follows 3(a), but the gaps between beam selection and the other two selection methods are raised to 2.5 and 7.5 dB at 14 bits/s/Hz.

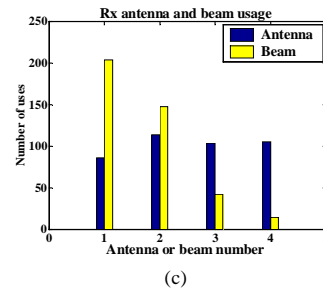
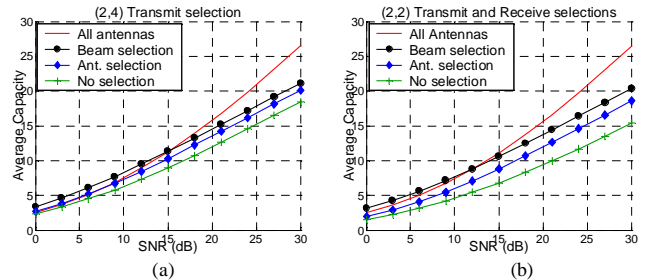

Figure 3: With LOS (Link T2-R1): (a) Transmit selection. (b) Transmit & Receive selection. (c) Antenna and Beam.

Figure 3(c) shows the usage of each receive antenna or beam in selection methods. Apparently most of the

multipath is in Beam 1 and 2. The other two beams are hardly used. For the antenna selection method, each antenna is evenly used. Antenna selection depends on the small-scale fading, which varies with frequency; therefore, the selected antennas at one frequency are usually not appropriate for some other frequencies if the two frequencies are separated by more than one coherence bandwidth. This explains why the usage of antennas is close to uniformly distributed since the outcomes of channel matrices are sampled from the frequency bandwidth of 500 MHz. Beam selection, on the other hand, depends on the path angles of arrival, which are the same for entire frequency band. This feature should make beam selection more attractive for the wideband application.

Figure 4 shows the measured results for channel T7–R2 where the LOS is not available. In this case, the performance difference between beam and antenna selection is reduced primarily because the angular spread is increased. We notice from Figure 4(c) that beam usage is more uniform than in the preceding example.

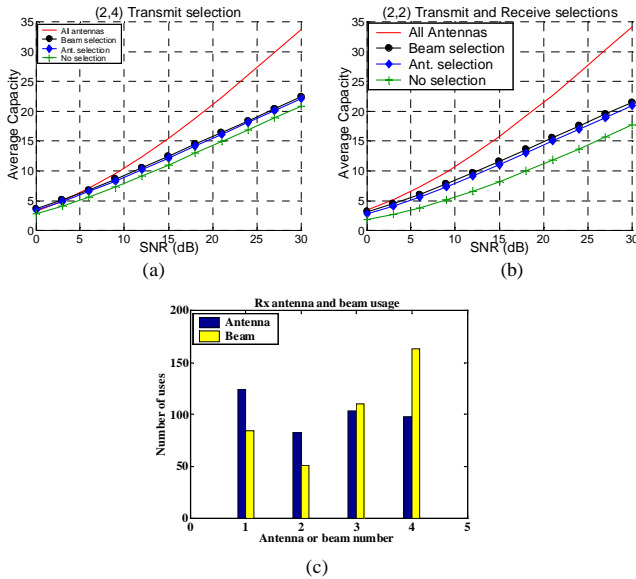

Figure 4: No LOS (Link T7-R2): (a) Transmit selection. (b) Transmit & Receive selection. (c) Antenna and beam usage.

### B. With Interference

The channels with interference discussed here are from a simple 4-node network, which is also employed in [11]. As shown in Figure 5, there are two co-channel links, Link 1–2 and Link 3–4. Transmitter 1 makes interference on Receiver 4 and Transmitter 3 makes interference on Receiver 2.

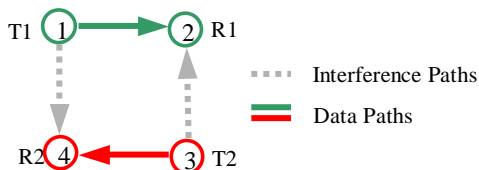

Figure 5: The signal model with interference.

In the following discussion, all four links are noise-normalized individually such that the signal links have the same SNR, and the signal-to-interference ratio (SIR) is equal to 1. The throughput is defined as the summation of the capacities of the intended links, i.e.,  $C_{\text{tot}} = C_{12} + C_{34}$ . Here we also assume the channel information is not available for the transmitter. The network topology will be described by a pair of links [11]. Topology I, (T2–R1, T7–R2), represents channels with less correlated interference and is indicated by the pair of solid arrows in Figure 2. On the other hand, Topology II, (T3–R1, T4–R2), represents channels with highly correlated interference, and is indicated by the dashed arrows in Figure 2.

The throughputs in Topology I are demonstrated in Figure 6, where “T-Beam” (“T-Antenna”) means that two beams (antennas) are selected at the transmit site only, and “TR-Beam” (“TR-Antenna”) means that two beams (antennas) are selected at each of the Tx and Rx ends. The curve for “All Antennas,” which indicates the condition when all four antennas are employed, is used as a reference. “No selection” curve shows the performance of the system when the first  $n_T$  or  $n_R$  antennas are used at transmit and receive ends.

We recall that the “All antennas” case has the best performance in the channels without interference. However, when MIMO links interfere, “All antennas” suffers from a lack of stream control [12], as shown in Figure 6. The slope of both transmit beam and antenna selection is about 4 bits/3dB at high SNR, which is equal to the theoretical slope of systems with four data streams.

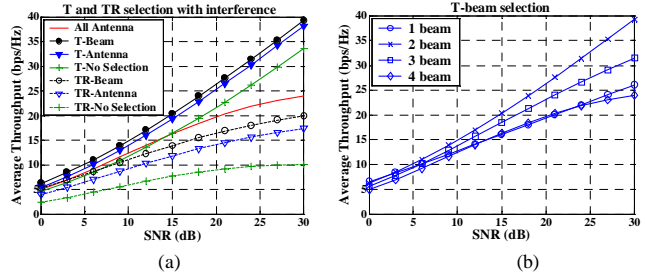

Figure 6: Narrowband channel with less correlated interference (T2–R1, T7–R2): (a) Throughput of various methods. (b) Performances with various numbers of beams.

The T-Beam selection outperforms the T-Antenna selection and no selection by less than 1 dB and more than 4 dB, respectively, at 20 bits/s/Hz. When the selection method is applied to both ends, the performance degrades because each receiver’s two channels are overwhelmed by four streams. This situation, which corresponds to a lack of stream control, could occur because stream control requires extra signalling in a network, and therefore may not be used. Under this circumstance, the difference between the beam and antenna selection methods is increased to 6 dB, and the performance of no selection is far behind them. Figure 6(b) shows the performances for various beam numbers. At higher SNR, the two-beam system has the best performances.

When the interference is highly correlated with the signal, as in Figure 7, the overall throughput is decreased

compared to the previous uncorrelated interference case. In this condition, the slope is reduced to 3bits/3dB at high SNR range. However, the relative performance difference among various methods discussed so far is about the same, and two-beam system still has the best performance.

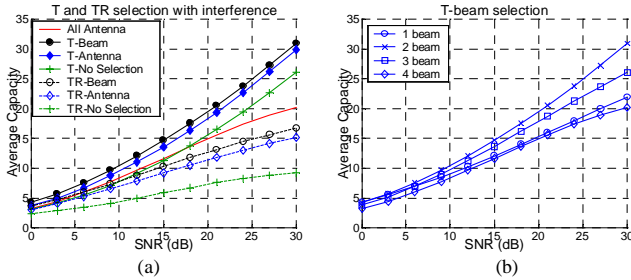

Figure 7: Highly correlated interference (T3–R1,T4–R2): (a) Throughput of various methods. (b) Performances with various numbers of beams.

#### IV. WIDEBAND MIMO CHANNELS

The robustness of the beam selection method in wideband channels was hypothesized in the previous subsection. We assume the channel information is not fed back to the transmitter, so the open-loop capacity of the wideband channels is the integration of the flat-fading channel over the 500 MHz bandwidth. The throughputs in wideband channels are shown in Figure 8.

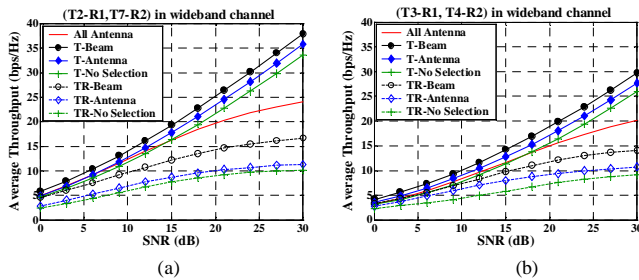

Figure 8: Wideband channels with (a) less correlated interference and (b) highly correlated interference.

The difference between T-Beam selection and T-Antenna selection is increased to 1.5 dB at 20 bits/s/Hz for the channel with less correlated interference. With highly correlated interference, the difference is 1.8 dB at 20 bits/s/Hz, but the slopes for T-Beam and T-Antenna selection methods are reduced to 3bits/3dB. When the selection is employed at both ends, the performance difference increases to more than 15 dB at 10 bits/s/Hz. For the highly correlated interference, the difference is about 8 dB at 10 bits/s/Hz when selection is employed at both ends. Although TR-Beam is much better than TR-Antenna because of the interference suppression provided by the beam patterns, TR-Beam still suffers for lack of stream control. Overall, the throughput of selection at transmit end is better than the selection at both ends. However, under stream control, the difference between beam and antenna selection seems surprisingly small for such a wide bandwidth in the indoor environment. One possible reason for the small difference is the wide beamwidth caused by small number of antennas, which impacts the interference

suppression capability of the Butler matrix. The effect of increasing the number of antennas needs further investigation.

#### V. CONCLUSION

The comparison of beam selection and antenna selection in the (4,4) MIMO system has been demonstrated. These results are based on measured data from an indoor environment at 5.8GHz. Selection of two antennas or beams from a total of four is considered. With stream control, and assuming lossless RF components, selection provides an improvement over no selection, and beam selection is slightly better than antenna selection. However, the SNR improvements of selection over non-selection are never more than 4dB. Since the insertion losses of real switches and beamformers could combine to be that much or more, there is little justification for using selection of two from four under stream controlled conditions. On the other hand, when there is no stream control, the SNR improvements of selection, and particularly beam selection, would more than compensate the insertion losses.

#### REFERENCES

- [1] G.J. Foschini and M.J. Gans, "On limits of wireless communications in a fading environment when using multiple antennas," *Wireless Personal Communications*, pp.311-335, 1998.
- [2] R.W. Heath, S. Sandhu, and A. Paulraj, "Antenna selection for spatial multiplexing systems with linear receivers," *IEEE Communications Letters*, vol. 5, pp. 142-144, April 2001.
- [3] D. Gore and A. Paulraj, "Space-time block coding with optimal antenna selection," *IEEE International Conference on Acoustics, Speech, and Signal Processing*, vol. 4, pp. 2441-2444, 2001.
- [4] K. U-yen, J.S. Kenney, T. Assavapokee, "An optimisation technique for low-loss  $n \times m$  microwave switch matrices," *IEEE Radio and Wireless Conference*, Boston, MA, Aug. 2003.
- [5] R.J. Mailloux, *Phase Array Antenna Handbook*, Artech House, Inc., 1994.
- [6] Personal communication with Prof. J. Stevenson Kenney.
- [7] K-H. Li and M.A. Ingram, "Space-Time-Block-Coded OFDM systems with RF beamformers for high-speed indoor wireless communications," *IEEE Trans. on Communications*, vol. 50, pp. 1899-1901, Dec. 2002.
- [8] J-S. Jiang and M.A. Ingram, "Enhancing measured MIMO capacity by adapting the locations of the antenna elements," *IEEE Personal, Indoor, and Mobile Radio Communications*, vol.3, pp. 1027-1031, 2002.
- [9] J-S. Jiang, *Measurement, Modeling, and Performance Analysis of Indoor MIMO Channels*, Ph.D dissertation in preparation, Georgia Institute of Technology, 2003.
- [10] D.W. Bliss, K.W. Forsythe, A.O. Hero, and A.F. Yegulalp "Environmental issues for MIMO capacity," *IEEE Trans. on Signal Processing*, pp.2128-2142, Sep. 2002.
- [11] M.F. Demirkol, and M.A. Ingram, "Control using capacity constraints for interfering MIMO links," *IEEE Personal, Indoor, and Mobile Radio Communications*, vol.3, pp. 1032-1036, 2002.
- [12] M.F. Demirkol and M.A. Ingram, "Stream control in networks with interfering MIMO links," *Proc. of IEEE Wireless Communications and Networking Conference*, Mar. 2003.