

TOPOLOGICAL REGULAR NEIGHBORHOODS

ROBERT D. EDWARDS

*Preparation of the electronic manuscript was supported by NSF Grant DMS-0407583. Final editing
was carried out by Fredric Ancel, Craig Guilbault and Gerard Venema.*

ABSTRACT. This article is one of three highly influential articles on the topology of manifolds written by Robert D. Edwards in the 1970's but never published. Organizers of the Workshops in Geometric Topology (<http://www.uwm.edu/~craigg/workshopggtt.htm>) with the support of the National Science Foundation have facilitated the preparation of electronic versions of these articles to make them publicly available. Preparation of the first of those articles "Suspensions of homology spheres" was completed in 2006. A more complete introduction to the series can be found in that article, which is posted on the arXiv at: <http://arxiv.org/abs/math/0610573v1> and on a web page devoted to this project: <http://www.uwm.edu/~craigg/EdwardsManuscripts.htm>

Preparation of the second article "Approximating certain cell-like maps by homeomorphisms" is nearing completion. The current article "Topological regular neighborhoods" is the third and final article of the series. (**Note.** This ordering is not chronological, but rather by relative readiness of the original manuscripts for publication.) It develops a comprehensive theory of regular neighborhoods of locally flatly embedded topological manifolds in high dimensional topological manifolds. The following original abstract for that paper was also published as an AMS research announcement:

Original Abstract. (AMS Notices Announcement): A theory of topological regular neighborhoods is described, which represents the full analogue in TOP of piecewise linear regular neighborhoods (or block bundles) in PL. In simplest terms, a topological regular neighborhood of a manifold M locally flatly embedded in a manifold Q ($\partial M = \emptyset = \partial Q$ here) is a closed manifold neighborhood V which is homeomorphic fixing $\partial V \cup M$ to the mapping cylinder of some proper surjection $\partial V \rightarrow M$. The principal theorem asserts the existence and uniqueness of such neighborhoods, for $\dim Q \geq 6$. One application is that a cell-like surjection of cell complexes is a simple homotopy equivalence (first proved for homeomorphisms by Chapman). There is a notion of transversality for such neighborhoods, and the theory also holds for locally tamely embedded polyhedra in topological manifolds. This work is a derivative of the work of Kirby-Siebenmann; its immediate predecessor is Siebenmann's "Approximating cellular maps by homeomorphisms" *Topology* 11(1972), 271-294.

This version of Part I is bare in spots and short on polish, but experts will find all necessary details. Part II is only sketched.

CONTENTS

Part I.	4
0. Introduction	4
1. Notation, definitions and some examples	4
2. Statement of results; general remarks	11
3. Homotopy properties of TRN's	13
4. Cone-like TRN's are mapping cylinder TRN's	17
5. The Handle Straightening Theorem and Lemma	17

6. Proof of Existence-Uniqueness Theorem	23
7. Local contractibility of the space of cone-like retractions; cone-like homotopies	23
8. Topological regular neighborhoods of polyhedra in manifolds	24
9. CW complexes	25
10. Concerning mapping cylinder neighborhoods of other compacta	28
11. Appendix: An extension of some well known homotopy theorems	30
Part II.	31
12. Additional topics	31
References	31

Note from the editors. This manuscript is an electronic version of a handwritten manuscript obtained from the author and dating back to 1973. As noted in the abstract, this is not a complete and polished work. Part I is nearly complete but lacking in a few details; a plan for Part II is described in the manuscript, but there is no evidence it was ever written. Despite its incomplete nature, the handwritten version of this manuscript was widely circulated and read. Its influence can be deduced from its appearance (sometimes under the alternative title “TOP regular neighborhoods”) in the bibliographies of a large number of important papers from that era.

In the process of editing the original manuscript, some obvious ‘typos’ were corrected and a few other minor improvements were made. For example a number of missing references, which the author had intended to fill in later, have been included, and others were updated from preprint status to their final publication form. (This accounts for a few post-1973 references in the bibliography.) In a few places, modern notation—more compatible with a `Tex` document—replaces earlier notation. Otherwise, this version remains faithful to the original. In particular, no attempt was made to complete unfinished portions of the manuscript. Notes from the author (sometimes to himself) about missing details or planned improvements are included. The decision to leave the manuscript largely unaltered leads to a few awkward situations. For example, some passages make references to the unwritten ‘Part II’; and in a few places there are incomplete sentences—sometimes due to phrases cut off or rendered unreadable by Xerox machines from long ago. A missing portion of text is indicated by a short blank line: _____. Despite the minor imperfections, readers will find much interesting and important mathematics, and some excellent exposition, on these pages.

The editors apologize and accept full responsibility for any new errors that crept into the manuscript during the conversion process.

Part I.

0. INTRODUCTION

A topological regular neighborhood of a manifold M locally flatly embedded in a manifold Q ($\partial M = \emptyset = \partial Q$ here; all manifolds topological) is most easily defined as a closed manifold neighborhood V of M in Q such that $(V; \partial V, M)$ is homeomorphic to the mapping cylinder $(Z(r); \partial V, M)$, of the restriction to ∂V of some proper retraction $r : V \rightarrow M$. The basic aim of this paper is to prove the existence and uniqueness of such neighborhoods, for $\dim Q \geq 6$. This is essentially accomplished in Sections 5 and 6. It turns out that such neighborhoods are more useful if their definition is given in less stringent form. The alternative (but equivalent) definition is given in Section 1 and developed in Sections 3 and 4.

Topological regular neighborhoods can be regarded as the analogue in TOP of block bundles in PL. They have the disadvantage of certain dimension restrictions, but they have the advantage of a bit more flexibility: certain pathological fibers are permitted and conversely certain nice fibers can be demanded.

For example, the following is true: if M^m is a locally flat submanifold of Q^{m+q} (say no boundaries), $m + q \geq 6$, then M has a closed manifold mapping cylinder neighborhood V in Q (as above) such that all fibers $\{r^{-1}(x)\}$ are locally flat q -discs which intersect ∂V in locally flat $(q - 1)$ -spheres.

Hence one feature of topological regular neighborhoods is that they may serve as ersatz disc bundle neighborhoods in dimensions where the latter may fail to exist (see Remark 1.3). However, they have other uses as well, for example for showing that a cell-like map of cell complexes is a simple homotopy equivalence, and transversality. The theory also extends to tamely embedded polyhedra in topological manifolds.

There are several other prior and related neighborhood theories in the literature, but we defer discussion of these until Section 2, after definitions.

This work grew out of my alternative proof [E₂] of Chapman's Theorem that a topological homeomorphism of polyhedra is a simple homotopy equivalence. In fact, it was developed to correct a flaw in my first proof of that theorem, a flaw which it turned out had a much simpler remedy. (The flaw was an implicit assumption that all triangulations are combinatorial; the remedy is represented by Theorem 1.2 in [E₁].)

I would like to thank L. Siebenmann for his many valuable comments and suggestions concerning this paper. Also, I thank Alexis Marin and Ron Stern for their participation in its development.

1. NOTATION, DEFINITIONS AND SOME EXAMPLES

Throughout this paper, we will adhere to the following notational conventions.

$$B^n = [-1, 1]^n \subset \mathbb{R}^n = \mathbb{R}^n \times 0 \subset \mathbb{R}^q.$$

∂B^n or \dot{B}^n , $\text{int } B^n$ or \dot{B}^n , rB^n and $r\partial B^n$ (for $r > 0$) are all used in the usual ways. D^n is used to denote any homeomorphic copy of the unit ball $\{(x_1, \dots, x_n) \in \mathbb{R}^n \mid \sum x_i^2 \leq 1\}$ in \mathbb{R}^n and S^{n-1} any homeomorphic copy of its boundary; if the context requires, regard D^n and S^{n-1} as actually being the unit ball and sphere. (Reason for this rigmarole: Sometimes its useful to have distinct n -cells B^n and D^n around.)

Given map $f : X \rightarrow Y$, let $Z(f)$ denote the mapping cylinder and $\rho : Z(f) \rightarrow Y$ the mapping cylinder retraction. Thus

$$Z(f) = (X \times [0, 1] \sqcup Y) / \{(x, 1) \sim f(x) \text{ for } x \in X\}$$

and $\rho(x, t) = f(x)$.

A map of pairs $f : (X, A) \rightarrow (Y, B)$ is *faithful* if $f^{-1}(B) = A$, not more. We prefer to save ‘proper’ for its more widespread meaning: $f : X \rightarrow Y$ is *proper* if preimages of compact sets are compact.

The notation $f : X \succrightarrow Y$ indicates that $\text{domain}(f) \subset X$, not necessarily equal to X .

Suppose M^m is a topological manifold (with or without boundary, compact or not). The following definition is the first of two.

Definition 1 (Mapping cylinder version). *An (abstract) **topological regular neighborhood** of M^m (TRN for short) is a triple (V^{m+q}, M^m, r) where V is a manifold-with-boundary and $r : V \rightarrow M$ is a proper retraction such that*

- (1) $(M, \partial M) \hookrightarrow (V, \partial V)$ is a faithful, locally flat inclusion (*faithful* $\equiv M \cap \partial V = \partial M$),
- (2) $\delta V \equiv r^{-1}(\partial M)$ is a collared codimension 0 submanifold of ∂V (define $\dot{V} = \text{cl}(\partial V - \delta V)$ and $\check{V} = V - \dot{V}$), and
- (3) $(V; \dot{V}, M, r)$ is isomorphic (keeping $\dot{V} \cup M$ fixed) to the mapping cylinder of $r| : \dot{V} \rightarrow M$, that is, $(V; \dot{V}, M, r) \cong (Z(r|_{\dot{V}}); \dot{V}, M, \rho)$ where ρ is the mapping cylinder retraction

This definition, although quite natural, turns out to be too restrictive for certain purposes. For example, one would like the composition of TRN’s to be a TRN. Consider:

Example 1. (See Figure 1.) *This example describes two mapping cylinder TRN’s $r_1 : V_1 \rightarrow V_2$ and $r_2 : V_2 \rightarrow J$ whose composite $r_2 r_1 : V_1 \rightarrow J$ is not a mapping cylinder TRN.*

For the purposes of this example, let $I = J = K = [-1, 1]$, to be thought of as first, second, and third coordinate intervals in \mathbb{R}^3 .

Let $(J \times K, J, r_0)$ be the mapping cylinder TRN as pictured in Figure 1a, such that $r_0^{-1}(0) = \Delta^1 \vee \Delta^2$ is the only non-interval point inverse. Product this TRN with the interval I to get

$$(V_1, V_2, r_1) \equiv (I \times J \times K, I \times J, \text{id}_I \times r_0)$$

as shown in Figure 1b.

Let $V_2 = I \times J \xrightarrow{r_2} J$ be obtained from the standard-projection TRN $\pi_J : I \times J \rightarrow J$ by a slight perturbation of the projection map π_J , as shown in Figure 1c. Specifically,

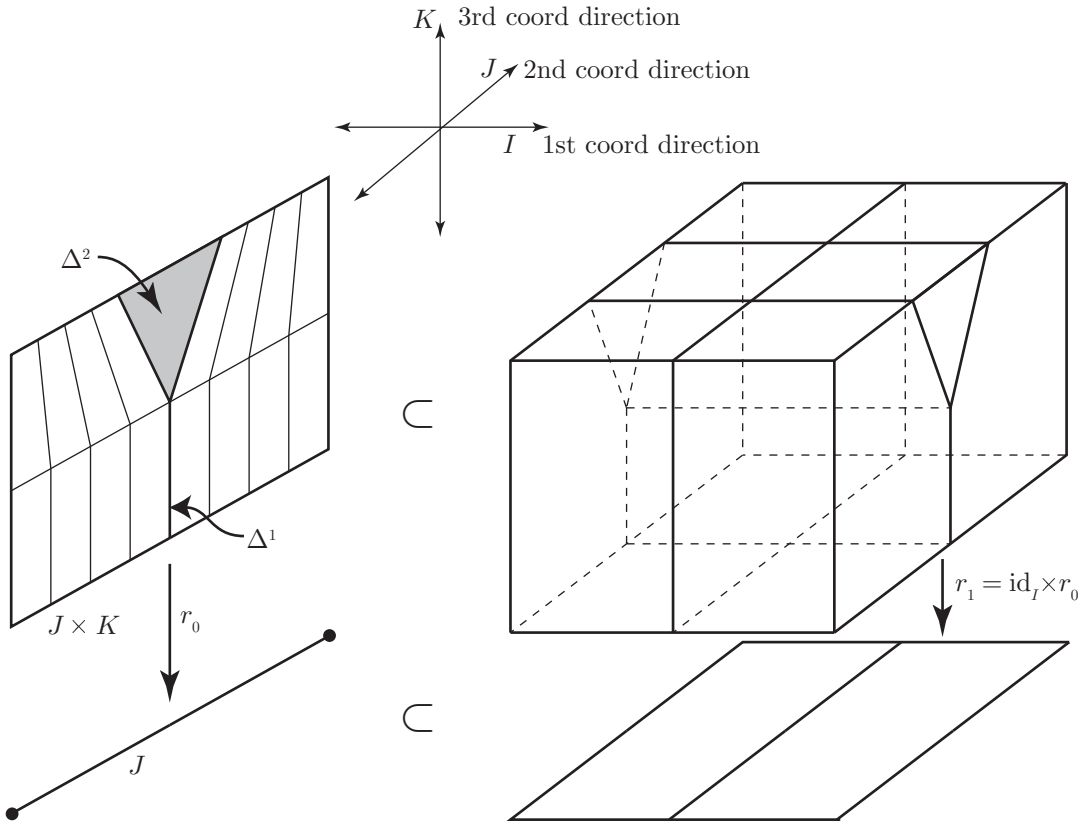

Figure 1a

Figure 1b

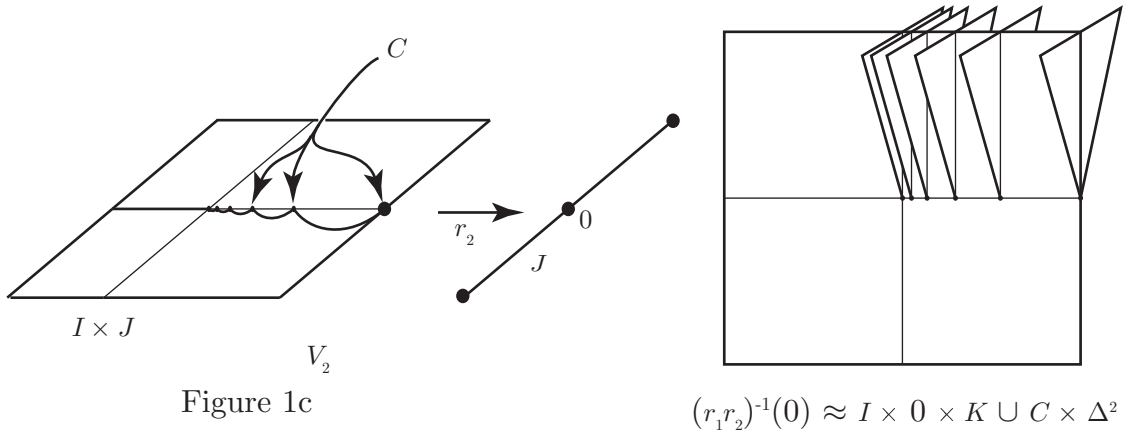

Figure 1c

$$(r_1, r_2)^{-1}(0) \approx I \times 0 \times K \cup C \times \Delta^2$$

FIGURE 1. Example 1: Composition of TRN's

let $h : I \times J \rightarrow I \times J$ be a $(t \times J)$ -level preserving homeomorphism such that

$$h(I \times 0) \cap I \times 0 = C \equiv \text{cl}\{(1/n, 0) \mid n > 0\} \subset I \times 0,$$

and define $r_2 = \pi_J h^{-1} : I \times J \rightarrow J$.

The composition $r_2 r_1 : V_1 \rightarrow J$ is not a mapping cylinder projection, as $(r_2 r_1)^{-1}(0) \approx (I \times 0 \times K) \cup (C \times \Delta^2)$, which is not a cone. See Figure 1d.

Before giving the second definition, it is worth considering the analogous situation in PL for motivation. There, one can define an abstract regular neighborhood of a manifold M (without boundary here) as a triple (V, M, r) where V is a manifold with boundary, $M \subset \text{int } V$ and $r : V \rightarrow M$ is a PL collapsible retraction, where *collapsible* means each point inverse $r^{-1}(x)$ is a collapsible polyhedron. This is M. Cohen's observation [Co₂], and it provides an alternative way of defining block bundles [RS₁, §4]. Cohen shows that such a V has topological mapping cylinder structure ([Co₁]; one has to be careful with PL mapping cylinders [?]). With this definition, the composition of PL regular neighborhoods, as defined above, is readily a PL regular neighborhood [Co₂, Lemma 8.6].

The most general analogue in TOP of a piecewise linear collapsible polyhedron is a cell-like compactum. This suggests the topological adaptation of Cohen's definition. First we need some preliminary definitions, which we give in anodyne form for the nonexpert in shape theory.

Let X be a finite dimensional compact metric space. Such an X is *cell-like* if X embeds in some euclidean space \mathbb{R}^q so that its image is cellular, that is, the intersection of open q -cells. Similarly, X is *k-sphere-like* if X embeds in some euclidean space $X \hookrightarrow \mathbb{R}^q$ so that $X = \bigcap_{i=1}^{\infty} f_i(S^k \times \mathbb{R}^{q-k})$ where each $f_i : S^k \times \mathbb{R}^{q-k} \rightarrow \mathbb{R}^q$ is an embedding, and image $f_{i+1} \hookrightarrow$ image f_i is a homotopy equivalence. Also, X is *k-UV* if given any embedding $X \hookrightarrow \mathbb{R}^q$ and any neighborhood U of X in \mathbb{R}^q , there is a neighborhood V of X , $V \subset U$, such that any map $\alpha : S^k \rightarrow V$ is null-homotopic in U . X is *UV^k* if it is *j-UV* for $0 \leq j \leq k$. It is the message of shape theory that these properties are intrinsic properties of X and can be so characterized, without any reference to a specific embedding.

An inclusion $Y \hookrightarrow X$ of a closed subset Y into a locally compact, finite-dimensional separable metric space X is a *shape equivalence* if for any embedding $X \hookrightarrow Q$ of X onto a closed subset of a manifold Q (i.e., proper embedding), the following holds: given neighborhoods U of X in Q and W of Y in Q , there is a neighborhood V of X in Q such that V homotopically deforms into W in U , keeping some neighborhood N of Y fixed. That is, there is a homotopy $h_t : V \rightarrow U$, $t \in [0, 1]$, joining $\text{id}_V = h_0 : V \rightarrow U$ to a map $h_1 : V \rightarrow W$, such that $h_t|_N = \text{id}$. (independent of t).

Shape theory says that if this definition holds for one proper embedding $X \hookrightarrow Q$, it hold for all [La2, p.499].

Suppose $r : V \rightarrow M$ is a proper retraction of spaces and \dot{V} is some distinguished closed subset of V . We use the notation $F_x = r^{-1}(x)$ and $\dot{F}_x = F_x \cap \dot{V}$, for $x \in M$. Recall r is *cell-like* (CE) if each F_x is cell-like [La]. We call r *cell-like, sphere-like* (CS) if each F_x is cell-like and each \dot{F}_x is sphere-like. Finally (and most importantly), we call r *cone-like* if each F_x is cell-like and the pair $(F_x - x, \dot{F}_x)$ is proper shape equivalent to $(\dot{F}_x \times [0, 1), \dot{F}_x)$. See [BS]. In order to obviate proper shape theory, we remark in advance that in the following definition, one can interpret *cone-like* to

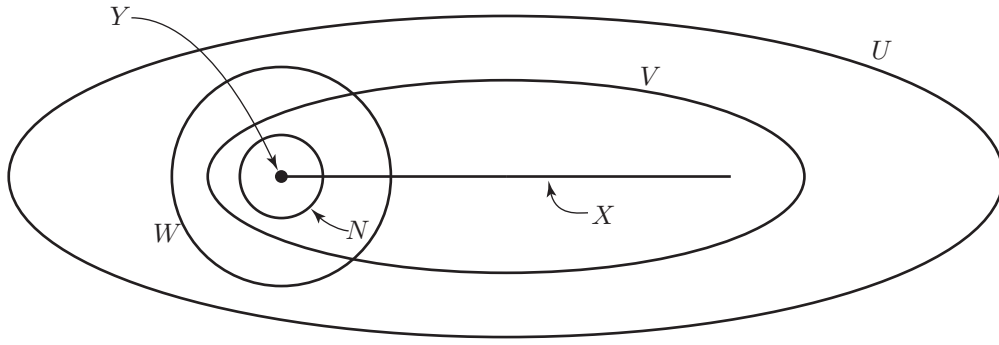

mean that r is CS and each inclusion $\dot{F}_x \hookrightarrow F_x - x$ is a shape equivalence (in fact, in codimension ≥ 3 one need only assume r is CE and each \dot{F}_x has property 1-UV; details are in §3).

M^m is a topological manifold (with or without boundary, compact or not). The following definition differs from the previous mapping cylinder version only in condition (3).

Definition 2 (Cone-like version). *An (abstract) **topological regular neighborhood** of M^m is a triple (V^{m+q}, M^m, r) where V is a manifold-with-boundary and $r : V \rightarrow M$ is a proper retraction such that*

- (1) $(M, \partial M) \hookrightarrow (V, \partial V)$ is a faithful locally flat inclusion.
- (2) $\delta V \equiv r^{-1}(\partial M)$ is a collared codimension 0 submanifold of ∂V (define $\dot{V} = cl(\partial V - \delta V)$ and $\check{V} = V - \dot{V}$), and
- (3) $r : V \rightarrow M$ is cone-like.¹

The following examples are to illuminate the definition. The last two are relevant only to codimension 2.

Example 2. *This example shows why r must be more than just cell-like. Let V be any compact contractible manifold and $m = \text{point} \in \text{int } V$ and $r : V \rightarrow m$ the retraction. Then r is CE, but if one wants uniqueness to hold in the theory, there must be some condition which force ∂V to be a homotopy sphere instead of just a homology sphere.*

Example 3. *This shows the need for the strong cone-like hypothesis on r in codimension 2. (For polyhedra, see Siebenmann's example in §8²). Let (B^{m+2}, D^m) be a knotted locally flat ball pair such that the sphere pair $(\partial B^{m+2}, \partial D^m) = (\partial B^{m+2}, \partial B^m)$ is standard. Recall that these can be constructed with $(B^{m+2} - D^m, \partial B^{m+2} - D^m)$ highly connected [Wa]. There is a CS retraction $r : B^{m+2} \rightarrow D^m$ which is a standard B^2 -fibered projection over $D^m - 0$ and such that F_0 is homotopy equivalent to the contractible space $B^{m+2} - (D^m - 0)$, with $\dot{F}_0 \approx S^1 \times B^m$. Since (B^{m+2}, D^m) is not standard, it is necessary to rule out such an r .*

¹See the note at bottom of page 13.

²**Note from editors:** In fact, this example did not make it into §8.

Example 4. *This shows that in codimension 2, it is not enough to just assume that r is cell-like and each inclusion $\dot{F}_x \hookrightarrow F_x - x$ is a shape equivalence (as opposed to the proper shape equivalence in the definition of cone-like). **Note.** This example is incomplete. It requires a knotted embedding $f : S^n \rightarrow S^{n+2}$ which permits a concordance $F : S^n \times I \rightarrow S^{n+2} \times I$ to the standard S^2 so that $S^{n+2} - f(S^n) \hookrightarrow S^{n+2} \times I - F(S^n \times I)$ is a homotopy equivalence (everything locally flat). Then we could construct this example.*

Remark 1. *(Concerning δV). If (V, M, r) is a TRN of M , then $(\delta V, \partial M, r|_{\delta V})$ is a TRN of ∂M (either definition). **Note:** $(\delta V)^\cdot = \partial \dot{V}$, which we will denote $\delta \dot{V}$; also $(\delta V)^\circ = \partial \dot{V}$, which we will denote $\delta \dot{V}$. Actually, our definition of TRN for manifolds with boundary is not the most general, as one need not require δV to coincide with $r^{-1}(\partial M)$. We postpone this relaxation and its details until the discussion of neighborhoods of polyhedral pairs in Part II, where it becomes necessary.*

Remark 2. *(Concerning the equivalence of definitions). It is routine to show that a mapping cylinder TRN is a cone-like TRN, using definitions. The converse of course is not strictly true, but it is as true as could be expected: if (V, M, r) is a cone-like TRN, then there is a mapping cylinder retraction $r' : V \rightarrow M$ which is arbitrarily close to r and agrees with r on \dot{V} ($\dim V \neq 4$; for $\dim V = 3$ see next remark). That is, $(V; \dot{V}, M, r') \approx (Z(r|_{\dot{V}}); \dot{V}, M, \rho)$ (rel $\dot{V} \cup M$). Details are in Section 4.*

Remark 3. *(Concerning non-locally flat embeddings of M). The definitions make perfect sense even if M is not locally flatly embedded in V . However, we cannot say anything non-trivial regarding existence-uniqueness in this case, and the techniques of this paper are no help there. Recall that if non-combinatorial triangulations of topological manifolds exist, i.e., if the double suspension of some genuine homology sphere is topologically homeomorphic to a real sphere, then there is a nonlocally flat embedding of S^1 (namely the suspension circle of the above suspension) into some sphere such that the embedding has a manifold mapping cylinder neighborhood. Further details are in [G1].*

If M^m is an arbitrary, possibly wild submanifold of Q^{m+q} , then $M = M \times 0 \subset Q \times \mathbb{R}^1$ is locally flat (no dimension restrictions; details recounted in [BrS] for $q > 1$). Thus if V is a TRN of a non-locally flatly embedded M (either definition), then $V \times [-1, 1]$ is a genuine TRN of $M \times 0$.

Remark 4. *(Concerning disc bundle neighborhoods). Topological regular neighborhoods may serve as a partial substitute for topological disc bundle neighborhoods in dimensions where the latter don't exist (although even when disc bundle neighborhoods exist, the uniqueness of TRN's is still useful; e.g., the topological invariance of simple homotopy type for cell complexes, §9). We recall what is known about existence-uniqueness of disc bundle neighborhoods. If $M^m \hookrightarrow \text{int } Q^{m+q}$ is a locally flat topological embedding, then M^m has a unique disc bundle neighborhood if $m + q \leq 3$ (semi-classical); $q = 1$ [Bro], $q = 2$, $m + q \geq 5$ [KS, AMS Notices 1971], $m \geq 3$, $m + q = 5, 6$ again essentially by [KS] (no upper bound on $m + q$ for existence);*

$m \leq q + 2$ [resp. $m \leq 6$, $m \leq 5$], $q \geq 7$ [resp. $q = 6$, $q = 5$], with existence holding for these m increased by one [St].

Hence the first $m + q \neq 4$ case where existence fails is $(m, m + q) = (4, 7)$, realizable by a counterexample of Hirsch.

Remark 5. (Concerning low dimensions). Subsequent theorems in Part I are all stated and proved for ambient dimension ≥ 6 (exceptions: the mapping cylinder theorem (§4) only requires ambient dimension ≥ 5 , and the local contractibility theorem (§7) has no dimension restrictions). As usual, all theorems hold when ambient dimension ≤ 2 (same proofs work) and all theorems hold when ambient dimension = 3, if we adopt the same convention that Siebenmann did in [Si₁] to get around the Poincaré conjecture: in the cone-like definition of TRN, assume in addition that each fiber F_x has a manifold neighborhood in V which is prime (\equiv there is no 2-sphere which separates the manifold into two non-cells). The mapping cylinder definition works as stated; its fibers automatically have this property. Ambient dimensions 4 and 5 remain a mystery because of the failure of the s -cobordism theorem there [Si₄]. But remember that in dimension 5, disc bundle neighborhoods exist and are unique (see preceding Remark).

We continue with more definitions. Two abstract topological regular neighborhoods (V_0, M, r_0) and (V_1, M, r_1) are *homeomorphic* if they are homeomorphic as triples $(V_0, M, \delta V_0) \approx (V_1, M, \delta V_1)$ keeping M fixed. Two such TRN's are *isomorphic* if they are homeomorphic via $h : (V_0, M, \delta V_0) \xrightarrow{\approx} (V_1, M, \delta V_1)$ so that $r_1 = r_0 h^{-1}$. This notion seldom arises because of its excessive strength.

If $(M, \partial M) \hookrightarrow (Q, \partial Q)$ is a faithful locally flat inclusion and V is a TRN of M in Q , we always assume (unless otherwise stated) that $V \cap \partial Q = \delta V$ and that $(\dot{V}, \delta \dot{V})$ is collared in $(Q - \dot{V}, \partial Q - \delta \dot{V})$. Two TRN's (V_0, M, r_0) and (V_1, M, r_1) of M in Q are *equivalent* in Q if there is a homeomorphism of Q whose restriction gives a homeomorphism of V_0 onto V_1 . They are *equivalent by ambient isotopy* if this homeomorphism can be chosen isotopic to id_Q through homeomorphisms of Q fixed on M . Invariably such an ambient isotopy will by construction leave a neighborhood of M fixed; if not, it can be so arranged by the isotopy extension theorem.

Although not explicitly required in the definition, all our equivalences by ambient isotopy $h_t : Q \rightarrow Q$, $t \in [0, 1]$, can be followed by a *cone-like homotopy* $r'_t : V_1 \rightarrow M$ (\equiv homotopy through cone-like retractions) joining $r'_0 = r_0 h_1^{-1}$ to $r'_1 = r_1$. This will sometimes prove useful, and will be mentioned explicitly whenever it arises.

We conclude this section with a useful example, which captures the difference between topological disc bundles and topological regular neighborhoods.

Example 5. (Capping Off). This example illustrates the fundamental compactification operation for TRN's. Suppose $r : \mathbb{R}^m \times B^q \rightarrow \mathbb{R}^m = \mathbb{R}^m \times 0$ is any cone-like retraction. Regard $S^m = \mathbb{R}^m \cup \infty$ and define $i = \text{inclusion} \times \text{id} : \mathbb{R}^m \times B^q \hookrightarrow S^m \times B^q$. Then $\bar{r} = S^m \times B^q \rightarrow S^m$ defined by

$$\bar{r} = \begin{cases} iri^{-1} & \text{on } (S^m - \infty) \times B^q \\ \text{projection to } \infty & \text{on } \infty \times B^q \end{cases}$$

is a cone-like retraction.

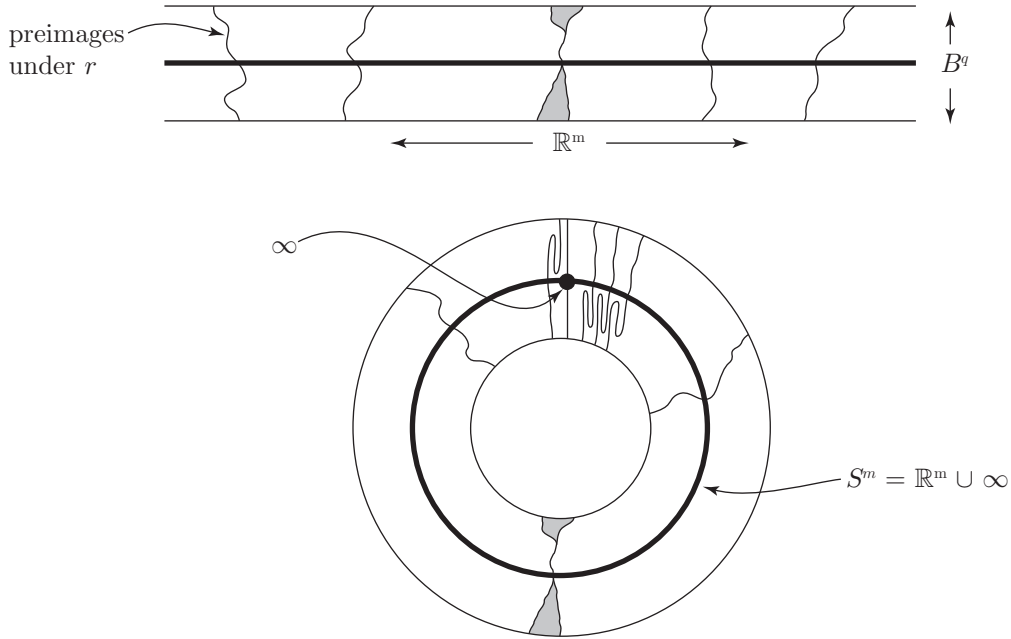

2. STATEMENT OF RESULTS; GENERAL REMARKS

The primary goal of Part I is to prove:

Theorem 2.1 (Existence-Uniqueness Theorem). *Suppose $(M^m, \partial M) \hookrightarrow (Q^{m+q}, \partial Q)$ is a faithful locally flat inclusion of topological manifolds, $m + q \geq 7$, (≥ 6 provided that $\partial M = \emptyset$ or that the conclusion already holds at ∂M). Then M has a topological regular neighborhood in Q , and any two are equivalent by ambient isotopy of Q .*

Addendum. The ambient isotopy $h_t : Q \rightarrow Q$ which realizes the homeomorphism of (V_0, M, r_0) to (V_1, M, r_1) may be chosen as the composition $h_t = h_{1,t}^{-1} h_{0,t}$ of two well-controlled ambient isotopies $h_{0,t}$ and $h_{1,t}$, where *well-controlled* means that each $h_{i,t}$, $t \in [0, 1]$, moves only those points which lie near V_i but not near M , along tracks which lie arbitrarily close to individual fibers of V_i . Furthermore, the cone-like retractions $r_0 h_1^{-1}$ and r_1 of V_1 to M , which are close by construction, can be joined by a small cone-like homotopy.

Remark 2.2 (Concerning special neighborhoods.) There are actually several useful subclasses of TRN's, each gotten by putting more restrictions on the fibers (F_x, \dot{F}_x) in either original definition. The Existence-Uniqueness Theorem holds for each class (with no change in the proof). Some sub-classes are in order of increasing restrictiveness:

- (1) (the original fibers, for comparison) $(F_x, \dot{F}_x) \overset{\text{shape}}{\sim} (B^q, S^{q-1})$
- (2) $(F_x, \dot{F}_x) \overset{\text{htpy equiv.}}{\sim} (B^q, S^{q-1})$

- (3) (1) plus F_x and \dot{F}_x are ANR's. Note this implies (2) holds.
- (4) $(F_x, \dot{F}_x) \stackrel{\text{homeo.}}{\approx} (B^q, S^{q-1})$
- (5) $(F_x, \dot{F}_x) \stackrel{\text{homeo.}}{\approx} (B^q, S^{q-1})$ and each (F_x, \dot{F}_x) is locally flat in (V, \dot{V}) .

Class (5) provides the nicest neighborhoods as far as existence is concerned, whereas the original cone-like definition offers the strongest uniqueness theorem. The cone-like homotopy of the Addendum belongs to the appropriate class.

The theory of topological regular neighborhoods is quite evidently modelled on the theory of PL regular neighborhoods and PL block bundles (which are really the same things, looked at from different perspectives, c.f. [RS_I, §4]. For the former, our preferred reference is Cohen [Co₂], and we have already remarked (in §1 after Example 1) how the treatment there is reflected here. Topological regular neighborhoods are not by definition partitioned into blocks, but they can be if the core manifold M has a handle structure (as it does if $\dim M \neq 4, 5$). This is discussed more fully in Part II. Topological regular neighborhood theory is completely parallel to block bundle theory, except for the bothersome dimension restrictions.

It is worth recalling other topological neighborhood theories which are already established. Suppose X is a compact subset of a topological manifold Q . If X is arbitrary there is little that can be said, except that most embeddings of X into Q (most \equiv a dense G_δ subset of all embeddings) are *locally tame*, defined to mean $Q - X$ is k -LC at X for all $0 \leq k \leq \dim Q - \dim X - 2$, where $\dim X$ is the covering dimension. Interestingly, in the trivial range $2 \dim X + 2 \leq \dim Q \neq 4$, homotopy implies ambient isotopy for such locally tame embeddings [Bry]. Below this range there is no hope of classifying neighborhoods as there may be uncountably many distinct neighborhood germs, even for X a locally tamely embedded ANR.

If X is shape dominated by a finite complex, there is a nice theory of open regular neighborhoods worked out by Siebenmann [Si₃]. Briefly, an open regular neighborhood of X in Q is an open neighborhood U which satisfies a certain compression property: given any compact subset K of U and any neighborhood W of X , there is a homeomorphism h of U having compact support and fixing a neighborhood of X , such that $h(K) \subset W$. Such neighborhoods have the homotopy type of X and are unique. They exist if and only if X is shape dominated by a finite complex, the "if" part assuming $\dim X \leq \dim Q - 3$ and $X \hookrightarrow Q$ locally tame. Furthermore X has an open radial neighborhood if and only if X actually has the shape of a finite complex (U is *radial* if $U - X \approx Y \times \mathbb{R}^1$ for some compactum Y). The difference between these situations is precisely measured by an obstruction in $\tilde{K}_0(\pi_1(U - X))$ that takes arbitrary values.

Johnson has recently observed these facts for X a topological manifold [Jo].

If X^m is a polyhedron embedded in a topological manifold Q^{m+q} , $q \geq 3$, Weller has observed that any two closed manifold neighborhoods of X which are PL regular neighborhoods in some (possibly unrelated) PL structures, are topological homeomorphic by Chapman's topological invariance of simple homotopy type.

This theory of topological regular neighborhoods represents a sharpened form of the topological regular neighborhood theory of Rourke-Sanderson [RS₄]. Briefly the

relation is this: given a fixed manifold M , the Rourke-Sanderson paper classifies germs at M of all manifold pairs (Q, M) , where M is embedded in Q as a locally flat submanifold; two such pairs (Q_0, M) and (Q_1, M) have equivalent germs if there are neighborhoods U_i of M in Q_i , $i = 0, 1$, such that $(U_0, M) \approx (U_1, M)$ keeping M fixed. This paper shows that each germ class $[(Q, M)]$ contains as a representative a unique topological regular neighborhood (V, M) . This paper recovers all the results of [RS₄]. We recall them as they arise.

A word on cell-like maps. They clearly play a central role in this paper, so it is worth repeating some history from [Si₁] (whose complete introduction is well worth reading). In 1967, D. Sullivan observed that the geometrical formalism used by S. P. Novikov to prove that a homeomorphism $h : M \rightarrow N$ of manifolds preserves rational Pontrjagin classes, uses only the fact that h is proper, and a *hereditary homotopy equivalence* in the sense that for each open $V \subset N$ the restriction $h^{-1}V \rightarrow V$ is a homotopy equivalence. Lacher [La] was able to identify such proper equivalences as precisely CE maps, providing one restricts attention to ENR's (= euclidean neighborhood retracts = retracts of open subsets of euclidean space).

This paper can be regarded as an extension of Siebenmann's [Si₁] in the following sense: he establishes that a cell-like surjection of n -manifolds is a limit of homeomorphisms. This paper establishes that a cone-like retraction $r : V \rightarrow M$ of manifolds is locally the limit of disc bundle projections. For this reasons our proofs in §5 bear strong resemblance to Siebenmann's proofs.

3. HOMOTOPY PROPERTIES OF TRN'S

The purpose of this section is to prove Proposition 3.1. below, which establishes certain basic homotopy properties of TRN's. The essential result, without refinements, is that the difference $V_1 - \dot{V}_0$ between two TRN's of the same manifold $M \subset V_0 \subset \dot{V}_1 \subset V_1$ is a proper h -cobordism.

For simplicity, we will always assume $\partial M = \emptyset = \delta V$ in this section, with the understanding that the $\partial M \neq \emptyset \neq \delta V$ versions of all results also hold.

When reading the following Proposition, it is worth keeping in mind that parts (1) and (2) are trivial for mapping cylinder TRN's.³

Proposition 3.1 (Homotopy Proposition). *Suppose (V, M, r) is a topological regular neighborhood (either definition). Then*

- (1) M is a strong deformation retract of V . In fact, the following type of partial deformations exist: Given any majorant map $\epsilon : M \rightarrow (0, \infty)$ and any neighborhood U of M in V , there is a neighborhood W of M , $W \subset U$, and a

³This section, as well as perhaps pages 7-7, could have benefitted from an overhaul for clarity. I wish to emphasize that in Proposition 3.1 what we really want is a property (0) from which (1) and (2) follow.

(0) $(V - M, \dot{V})$ is proper homotopy equivalent to $(\dot{V} \times [0, 1), \dot{V} \times 0)$, by an ϵ -controlled proper homotopy equivalence.

This property (0) is what "cone-like" is all about.

deformation $f_t : V \rightarrow V$, $t \in [0, 1]$, such that $f_0 = \text{id}_V$, $f_1(V) \subset U$ and for each t , $f_t|_W = \text{id}_W$ and $f_t(V - W) \subset V - W$, (i.e., W is ‘undisturbed’ by the homotopy), and rf_t is ϵ -close to r .

- (2) \dot{V} is a strong deformation retract of $V - M$. In fact, given $\epsilon : M \rightarrow (0, \infty)$, there is a deformation $g_t : V - M \rightarrow V - M$ (rel \dot{V}), joining $g_0 = \text{id}_{V-M}$ to a retraction $g_1 : V - M \rightarrow \dot{V}$, such that for each t , rg_t is ϵ -close to r .
- (3) If (V_0, M, r_0) is a TRN such that $V_0 \subset \dot{V}$ is a closed neighborhood of M in V , then the difference $(V - \dot{V}_0; \dot{V}_0, \dot{V})$ is a proper h -cobordism.

Part (3) is a straightforward consequence of parts (1) and (2). The remainder of this section is concerned with proving parts (1) and (2) for cone-like TRN’s.

Before proceeding to the proof, we make some brief asides. The first is to point out that in the definition of cone-like TRN, if one only assumes that $r : V \rightarrow M$ is CE instead of conelike, then the fibers F_x and their boundaries \dot{F}_x all have the cohomology properties one would expect. Namely, by duality, $\check{H}^*(\dot{F}_x) \approx H^*(S^{q-1})$ and $\check{H}^*(F_x - x, \dot{F}_x) = 0$ (here \check{H}^* denotes Čech cohomology). See details below. Also in codimension ≥ 3 , $F_x - x$ is 1-UV. However, as Example 2 shows, \dot{F}_x may not have the shape of S^{q-1} .

If one is only interested in establishing the non-proper, codimension ≥ 3 case of part (3) above, there is an especially simple proof, called to my attention by Alexis Marin.

Proposition 3.2 (Illustrative Proposition). *Suppose (V_i^{m+q}, M^m, r_i) , $i = 0, 1$, are **cell-like** TRN’s of M , with $V_0 \subset V_1$ and $q \geq 3$, such that all fiber boundaries $\{\dot{F}_{x,i} = r_i^{-1}(x) \cap \dot{V}_i \mid x \in M, i = 0, 1\}$ are 1-UV. Then the inclusion $\dot{V}_0 \hookrightarrow V_1 - M$ is a homotopy equivalence. Hence, if $V_0 \subset \dot{V}_1$, the difference $(V_1 - \dot{V}_0; \dot{V}_0, \dot{V}_1)$ is an h -cobordism (using the additional parallel facts that $\dot{V}_i \hookrightarrow V_i - M$ are homotopy equivalences, $i = 0, 1$).*

Proof. The cell-like retraction $r_i : V_i \rightarrow M$ is a homotopy equivalence by the theorem of Lacher.

The maps $V_i - M \hookrightarrow V_i$ and $\dot{V}_i \xrightarrow{\alpha} V_i \xrightarrow{r} M$ induce π_1 -isomorphisms, the first by general position and the others because r and $r\alpha$ are 1-UV surjections [La2, p.505]. Hence all universal covers are compatible, and we have covering TRN’s

$$\begin{array}{ccccc}
 \tilde{M} & \xleftarrow{\subset} & \tilde{V}_0 & \xrightarrow{\subset} & \tilde{V}_1 \\
 \downarrow & \xleftarrow{\tilde{r}_0} & \downarrow & \xrightarrow{\tilde{r}_1} & \downarrow \\
 M & \xleftarrow{\subset} & V_0 & \xrightarrow{\subset} & V_1 \\
 & \xleftarrow{r_0} & & \xrightarrow{r_1} &
 \end{array}$$

It suffices to show $\widetilde{V} \hookrightarrow \widetilde{V}_1 - \widetilde{M}$ induces homology isomorphisms, for then the theorems of Hurewicz and Whitehead apply. The topmost square below represents Lefschetz/Alexander duality and its naturality, and the remaining squares are the homology sequence of a pair. (**Note.** For simplicity, the \sim 's are omitted from the diagram.)

$$\begin{array}{ccc}
 H_v^{m+q-*}(V_0) & \xleftarrow[\text{inclusion}_*]{\approx} & H_c^{m+q-*}(M) \\
 \text{(Lefschetz Duality)} \downarrow \approx & & \approx \downarrow \text{(Alexander Duality)} \\
 H_*(V_0, \dot{V}_0) & \xrightarrow{\approx} & H_*(V_1, V_1 - M) \\
 \partial \downarrow & & \partial \downarrow \\
 H_{*-1}(\dot{V}_0) & \xrightarrow[\text{(Five Lemma)}]{\approx} & H_{*-1}(V_1 - M) \\
 \downarrow & & \downarrow \\
 H_{*-1}(V_0) & \xrightarrow[\text{inclusion}_*]{\approx} & H_{*-1}(V_1)
 \end{array}$$

□

Unfortunately the above proof has no straightforward generalization to the proper category and to codimension 2, and it provides no information about the tracks of the homotopies. For this reason we adopt the following approach, which is, in a sense, more elementary because it uses no algebra and duality, but unfortunately is more elaborate, using elementary shape theory.

The following discussion uses the notion of *resolution* of a TRN $r : V \rightarrow M$, which provides a way of compactifying deleted fibers $\{F_x - x\}$ by inserting a $(q-1)$ -sphere in place of x . The definition is local in character. Suppose $r : V^{m+q} \rightarrow \mathbb{R}^m$ is a TRN of \mathbb{R}^m (\mathbb{R}_+^m in the with-boundary case). Let $U \approx \mathbb{R}^m \times 2B^q$ be a neighborhood of $\mathbb{R}^m = \mathbb{R}^m \times 0$ in \dot{V} such that U is closed and collared in V . Let $\lambda : 2B^q \rightarrow 2B^q$ be the map $\lambda(B^q) = 0$, $\lambda|_{\partial 2B^q} = \text{id}$ and λ extended linearly on radial lines joining ∂B^q to $\partial 2B^q$ and define $p : V \rightarrow V$ by letting $p|_U = \text{id}_{\mathbb{R}^m} \times \lambda$ and $p|_{V-U} = \text{identity}$. Define $r' = rp : V \rightarrow \mathbb{R}^m$. Let F'_x denote

$$(r')^{-1}(x) = p^{-1}(F_x - x) \cup (x \times B^q)$$

with distinguished subsets $\dot{F}'_x = \dot{F}_x$, $(D_x, \dot{D}_x) = x \times (B^q, \partial B^q)$ and $A_x = F'_x - \text{int } D_x$.

It is another straightforward exercise to deduce parts (1) and (2) of Proposition 3.1 above from part (2) of the following Proposition, by applying it to successive coordinate charts of M to manufacture the desired deformations.

Proposition 3.3. *Suppose $r : V^{m+q} \rightarrow \mathbb{R}^m$ is a cone-like TRN, resolved to $r' : V \rightarrow \mathbb{R}^m$ as above. Then*

- (1) *for each $x \in \mathbb{R}^m$, the inclusions $\dot{F}'_x \hookrightarrow A_x$ and $\dot{D}_x \hookrightarrow A_x$ are shape equivalences, and*

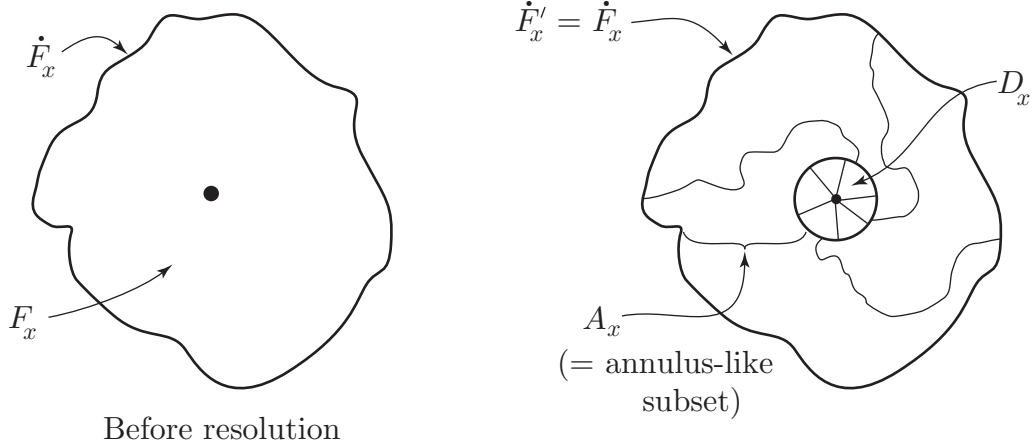

- (2) *the inclusions $\dot{V} \hookrightarrow V - \dot{U}$ and $\dot{U} \hookrightarrow V - \dot{U}$ are proper homotopy equivalences. In fact, given any majorant map $\epsilon : \mathbb{R}^m \rightarrow (0, \infty)$, there exist deformation retractions $f_t : V - \dot{U} \rightarrow V - \dot{U}$ (rel \dot{U}) of $V - \dot{U}$ into \dot{U} , and $g_t : V - \dot{U} \rightarrow V - \dot{U}$ (rel \dot{V}) of $V - \dot{U}$ into \dot{V} , such that both $r'f_t$ and $r'g_t$ are ϵ -close to r' .*

Note. The proof shows that the Proposition holds under the *a priori* weaker hypothesis that r be CS and each inclusion $\dot{F}_x \hookrightarrow F_x - x$ be a shape equivalence. It also holds if $q \geq 3$, r is CE, and each \dot{F}_x is 1-UV.

Proof of Proposition. Part (1). By the hypotheses and elementary shape theory, \dot{V} is a strong deformation retract of the noncompact $V - U$ in the ϵ -controlled manner suggested by part (2) (see below). For each x , this provides a shape map from A_x to \dot{F}_x : just push A_x into $V - U$, and homotope it out to \dot{V} , as close as desired to \dot{F}_x . This is a shape equivalence, the inverse of $\dot{F}_x \hookrightarrow A_x$.

Assuming r is conelike, that is, each $(A_x - \dot{D}_x, \dot{F}_x)$ is proper shape equivalent to $(\dot{F}_x \times [0, 1), \dot{F}_x \times 0)$, then in fact $(V - U, \dot{V})$ is proper homotopy equivalent to $(\dot{V} \times [0, 1), \dot{V} \times 0)$ by a well controlled homotopy, and this can be used to show each $\dot{D}_x \hookrightarrow A_x$ is a shape equivalence, as above.

Consider now the weaker hypothesis of the Note. By excision, each inclusion $\dot{D}_x \hookrightarrow A_x$ is degree 1 on Čech cohomology, and by hypothesis \dot{F}_x hence A_x has the shape of some sphere, necessarily S^{q-1} . Hence $\dot{D}_x \hookrightarrow A_x$ is a shape equivalence. Note that this argument fails when it is not known that \dot{F}_x has the shape of a sphere (c.f. Example 4).

Part (2). Assuming r is cone-like, then part (2) is a quick consequence of the ϵ -controlled proper homotopy equivalence $(V - U, \dot{V}) \sim (\dot{V} \times [0, 1), \dot{V} \times 0)$ mentioned in the second paragraph above, and in fact there is no need to prove part (1). On the other hand, if using the hypothesis of the Note, then one wants to know part (1) \Rightarrow part (2). This implication is a corollary of a Whitehead-type theorem for shape, which we state in the Appendix. \square

4. CONE-LIKE TRN'S ARE MAPPING CYLINDER TRN'S

The purpose of this section is to prove the equivalence of the two definitions given in §1. As already noted, a mapping cylinder TRN is clearly a cone-like TRN.

Theorem 4.1. *Suppose (V^{m+q}, M^m, r_0) is a cone-like topological regular neighborhood. Suppose $m + q \geq 6$, or that $m + q = 5$ and the conclusion below already holds for $(\delta V, \partial M, r_0)$. Then there is a mapping cylinder retraction $r_1 : V \rightarrow M$, arbitrarily close to r_0 , such that $r_1^{-1}(\partial M) = r_0^{-1}(\partial M) = \delta V$ and $r_1|_{\delta V} = r_0|_{\delta V}$ if $r_0|_{\delta V}$ is already a mapping cylinder retraction. Hence (V, M, r_1) is a mapping cylinder TRN. In addition there is an arbitrarily small homotopy of cone-like retractions $r_t : V \rightarrow M$, $t \in [0, 1]$, joining r_0 to r_1 , such that $r_t^{-1}(\partial M) = \delta V$ and $r_t|_{\delta V} = r_0|_{\delta V}$ if $r_0|_{\delta V}$ is already a mapping cylinder retraction.*

Proof. This is proved using radial engulfing (PL if desired) to effect a shrinking argument, just as in Edwards-Glaser [EG]. The homotopy comes for free. \square

5. THE HANDLE STRAIGHTENING THEOREM AND LEMMA

The Existence-Uniqueness Theorem is based on the following Handle Straightening Theorem, which is inspired by Siebenmann's Main Theorem in [Si₁]. In essence, it is gotten by crossing the source manifold in Siebenmann's theorem with B^q .

Recall the notation $f : X \succrightarrow Y$ means that domain f is a subset of X .

Theorem 5.1 (Handle Straightening Theorem). *Suppose given a cone-like TRN $(V^{m+q}, B^k \times \mathbb{R}^n, r)$, $k + n = m$, $m + q \geq 6$, along with an open embedding $f : B^k \times \mathbb{R}^n \times B^q \succrightarrow V$ defined near*

$$\text{Int} \equiv B^k \times \mathbb{R}^n \times 0 \cup \partial B^k \times \mathbb{R}^n \times B^q$$

such that $f(x, 0) = x$ for

$$x \in B^k \times \mathbb{R}^n; \quad f(\partial B^k \times \mathbb{R}^n \times B^q) = \delta V \equiv r^{-1}(\partial B^k \times \mathbb{R}^n)$$

and $r \circ f = \text{projection on } \partial B^k \times \mathbb{R}^n \times B^q$.

Then there exists a triangle of maps

$$\begin{array}{ccc} B^k \times \mathbb{R}^n \times B^q & & \\ \downarrow F \approx & \searrow R & \\ & & B^k \times \mathbb{R}^n \\ & \nearrow r & \\ V^{m+q} & & \end{array}$$

(not commutative)

such that

- (1) R is a cone-like TRN retraction to $B^k \times \mathbb{R}^n = B^k \times \mathbb{R}^n \times 0$, with $R^{-1}(\partial B^k \times \mathbb{R}^n) = \partial B^k \times \mathbb{R}^n \times B^q$,

- (2) F is a homeomorphism such that $F = f$ near \vdash ,
- (3) $R = rF$ over $B^k \times (\mathbb{R}^n - 4\mathring{B}^n) \cup \partial B^k \times \mathbb{R}^n$, and
- (4) $R = \text{projection}$ over $B^k \times B^n \cup \partial B^k \times \mathbb{R}^n$.

Remark 6. If we define $r' = RF^{-1}$, then

- a) r' is a q -disc fiber bundle projection over $B^k \times B^n \cup \partial B^k \times \mathbb{R}^n$, and
- b) $r' = r$ over $B^k \times (\mathbb{R}^n - 4\mathring{B}^n) \cup \partial B^k \times \mathbb{R}^n$.

Note. There is a cone-like homotopy joining r to r' , but its existence is not immediate from the proof below. The discussion of such homotopies is deferred until §. ____.

The Theorem above is deduced from the following Lemma using the inversion device introduced in [Si₁].

Lemma 5.2 (Handle Straightening Lemma). *The same data is given, and the same conclusion is drawn, except that (3) and (4) are replaced by*

- (3') $R = rF$ over $B^k \times B^n \cup \partial B^k \times \mathbb{R}^n$
- (4') $R = \text{standard projection}$ over $B^k \times (\mathbb{R}^n - 4\mathring{B}^n) \cup \partial B^k \times \mathbb{R}^n$.

Proof that Lemma implies Theorem. In this proof, the Handle Lemma is applied twice, the first time only to compactify V .

Let $S^n = \mathbb{R}^n \cup \infty$. The F and R given by the Handle Lemma provide, via compactification (see Example 5), the F_∞ and R_∞ in the triangle

$$\begin{array}{ccc}
 B^k \times S^n \times B^q & & \\
 \downarrow F_\infty \approx & \searrow R_\infty & \\
 & & B^k \times \mathbb{R}^n \\
 & \nearrow r_\infty & \\
 V_\infty & &
 \end{array}$$

(not commutative)

(The replacement $A \rightsquigarrow A_\infty$ for $A = \text{any of: } V, F, R, \text{ or } \vdash$, suggests compactification, while $A^\#$ below suggests the analogue of A in the inverted context.) Restrict F_∞ to a neighborhood of

$$\vdash^\# \equiv B^k \times (S^n - 0) \times 0 \cup \partial B^k \times (S^n - 0) \times B^q$$

in

$$B^k \times (S^n - 0) \times B^q$$

to get

$$f^\# : B^k \times (S^n - 0) \times B^q \rightsquigarrow V^\# \equiv V_\infty - r^{-1}(B^k \times 0).$$

The Handle Lemma can be applied to TRN's of $B^k \times (S^n - 0)$ by imagining $S^n - 0$ identified with \mathbb{R}^n by the natural inversion homeomorphism

$$\theta : \mathbb{R}^n \cup \infty \rightarrow \mathbb{R}^n \cup \infty$$

given by

$$\theta(y) = y/|y|^2 \quad \text{for } y \neq 0, \infty \quad \text{and} \quad \theta(0) = \infty \quad \text{and} \quad \theta(\infty) = 0.$$

In such inverted applications, the original subsets $B^k \times rB^n$ and $B^k \times (\mathbb{R}^n - r\mathring{B}^n)$ of $B^k \times \mathbb{R}^n$ are replaced by $B^k \times (S^n - (1/r)\mathring{B}^n)$ and $B^k \times ((1/r)B^n - 0)$ of $B^k \times (S^n - 0)$. (Note: Under this interpretation of inversion, the homeomorphism θ does **not** explicitly appear anywhere in the following proof).

Apply the Handle Lemma to the TRN $r^\# \equiv r_\infty| : V^\# \rightarrow B^k \times (S^n - 0)$ to get maps $F^\#$ and $R^\#$ in the triangle

$$\begin{array}{ccc} V_\infty - r^{-1}(B^k \times 0) \equiv V^\# & & \\ \uparrow F^\# \approx & \searrow r^\# \equiv r_\infty| V^\# & \\ & & B^k \times (S^n - 0) \\ & \nearrow R^\# & \\ B^k \times (S^n - 0) \times B^q & & \end{array}$$

(not commutative)

Thus

- (1) $R^\#$ is a cone-like TRN retraction to $B^k \times (S^n - 0)$ with $(R^\#)^{-1}(\partial B^k \times (S^n - 0)) = \partial B^k \times (S^n - 0) \times B^q$,
 - (2) $F^\#$ is a homeomorphism such that $F^\# = f^\#$ near $\vdash\#$
 - (3) $R^\# = r^\# F^\#$ over $B^k \times (S^n - \mathring{B}^n) \cup \partial B^k \times (S^n - 0)$, and
 - (4) $R^\# =$ standard projection over $B^k \times ((1/4)B^n - 0) \cup \partial B^k \times (S^n - 0)$.
- Extend $r^\#$ and $R^\#$ using r_∞ and R_∞ to get

$$\begin{array}{ccc} V^\# \hookrightarrow & & V_\infty \\ \uparrow F^\# & & \searrow r_\infty^\# \\ & & B^k \times S^n \\ & \nearrow R_\infty^\# & \\ B^k \times (S^n - 0) \times B^q \hookrightarrow & & B^k \times S^n \times B^q \end{array}$$

(not commutative)

We must extend $F^\#$ to a homeomorphism $F_\infty^\# : B^k \times S^n \times B^q \rightarrow V_\infty$. First restrict $F^\#$ to $B^k \times (S^n - (1/10)\mathring{B}^k) \times B^q$ and then extend over

$$D \equiv (B^k - (1 - \epsilon)\mathring{B}^k) \times (1/10)B^n \times B^q \cup B^k \times (1/10)B^n \times \epsilon B^q$$

via f (for some small $\epsilon > 0$) to get an embedding

$$G^\# : B^k \times S^n \times B^q - (1 - \epsilon)\mathring{B}^k \times (1/10)\mathring{B}^n \times (B^q - \epsilon\mathring{B}^q) \rightarrow V_\infty.$$

Now the difference $\text{cl}(V_\infty - \text{image}(G^\#))$ is a compact s -cobordism between manifolds-with-boundary

$$G^\#((1 - \epsilon)B^k \times (1/10)B^n \times \epsilon\mathring{B}^q)$$

and $\text{cl}(\partial V_\infty^\# - \text{image } G^\#)$, with product boundary cobordism.

$$G^\#(\partial[(1 - \epsilon)B^k \times (1/10)B^n] \times (B^q - \epsilon\mathring{B}^q)).$$

Hence this difference is a product, so $G^\#$ extends to $F_\infty^\#$ as desired.

Finally, taking restrictions to the original sets V , $B^k \times \mathbb{R}^n \times B^q$ and $B^k \times \mathbb{R}^n$ yields the triangle

$$\begin{array}{ccc} V_\infty & \longleftarrow & V \\ \uparrow F_\infty^\# & & \uparrow F_\infty^\#|_{\equiv F_1} \approx \\ B^k \times S^n \times B^q & \longleftarrow & B^k \times \mathbb{R}^n \times B^q \end{array} \quad \begin{array}{c} \searrow r \\ B^k \times \mathbb{R}^n \\ \nearrow R_1|_{\equiv R_\infty^\#} \end{array}$$

(not commutative)

The maps F_1 and R_1 satisfy properties (1) and (2) of the Handle Theorem, along with

(3'') $R_1 = rF_1$ over $B^k \times (\mathbb{R}^n - \mathring{B}^n) \cup \partial B^k \times \mathbb{R}^n$ and

(4'') $R_1 = \text{standard projection}$ over $B^k \times (1/4)B^n \cup \partial B^k \times \mathbb{R}^n$.

These are clearly equivalent to (3) and (4) of the Handle Theorem completing the proof that the Handle Straightening Lemma implies the Handle Straightening Theorem. \square

Proof of Handle Straightening Lemma. The proof is based on a diagram which derives from the classic diagram of Kirby-Siebenmann; its immediate predecessor is the diagram in [Si₁].

To make certain constructions precise, we make two preliminary modifications in the given data. First, by compression toward \vdash in $B^k \times \mathbb{R}^n \times B^q$, we arrange that f is defined on a neighborhood of $(B^k - (1/2)\mathring{B}^k) \times \mathbb{R}^n \times B^q \cup B^k \times \mathbb{R}^n \times (1/2)B^q$ in $B^k \times \mathbb{R}^n \times B^q$. Second, by redefining r over $B^k \times 4\mathring{B}^n$ by conjugation, we arrange that rf is standard projection over $(B^k - (1/2)\mathring{B}^k) \times 3B^n \cup \partial B^k \times \mathbb{R}^n$. Clearly there is no loss in proving the Lemma for these modified r and f .

The diagram is constructed essentially from the bottom up. All the right hand triangles commute, as do all the squares but two: the one below h and the one containing F . The details of the construction follow

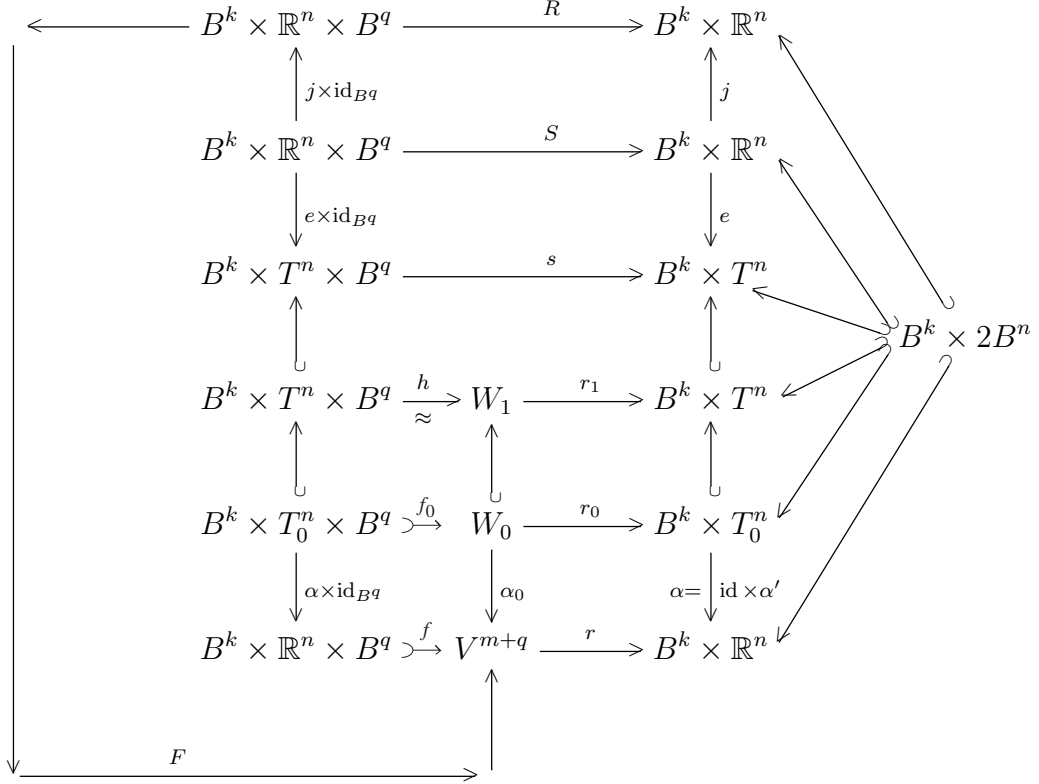

Main Diagram

Note. Details in the remainder of the proof are not yet completely filled in.

[**About e and p .**] Regard T^n as the quotient $\mathbb{R}^n / (8\mathbb{Z})^n$ of \mathbb{R}^n where, \mathbb{Z} denotes the integers, and let $e' : \mathbb{R}^n \rightarrow T^n$ be the corresponding quotient map. Define $e = \text{id}_{B^k} \times e'$. Abusively we regard $B^k \times rB^n \subset B^k \times T^n$ for $r < 4$. Choose $p \in T^n - 2B^n$ and let $T_0^n = T^n - p$.

[**About $\alpha : B^k \times T_0^n \rightarrow B^k \times 3\mathring{B}^n$.**] Let $\alpha' : T_0^n \rightarrow 3\mathring{B}$ be an immersion such that $\alpha'|_{2B^n} = \text{id}$. Define $\alpha = \text{id}_{B^k} \times \alpha'$. This makes the four triangles commute.

[**About $j : B^k \times \mathbb{R}^n \rightarrow B^k \times \mathbb{R}^n$.**] It is the non-surjective embedding obtained by restriction of the homeomorphism $J : \mathbb{R}^m \rightarrow 4\mathring{B}^m = 4\mathring{B}^k \times 4\mathring{B}^q$ which fixes precisely $2\mathring{B}^m$ and on each ray from the origin is linearly conjugate to the homeomorphism $\gamma : [0, \infty) \rightarrow [0, -)$ defined by $\gamma|_{[0, -]} = \text{id}$ and $\gamma(x) = \frac{1}{x}$.

[**About W_0, r_0, α_0 and f_0 .**] These are defined via pullback. Thus

$$W_0 = \{(x, y) \in V \times B^k \times (T^n - p) \mid r(x) = \alpha(y)\}$$

and $\alpha_0(x, y) = x$ and $r_0(x, y) = y$ and $f_0 \equiv (f|, rf|) : B^k \times (T^n - p) \times 0 \cup \text{_____} \rightarrow W_0$. We have that α_0 is an immersion, W_0 is a manifold and r_0 is a cone-like retraction to $f_0(B^k \times T_0^n \times 0)$, by the obvious generalization of [Si₁, Lemma 2.3]. Also, f_0 is naturally an open embedding of some neighborhood of $B^k \times T_0^n \times 0 \cup (B^k - (1/2)\dot{B}^k) \times T_0^n \times B^q$, and $r_0 f_0$ is standard projection on this set.

[Construction of W_1 , r_1 and h .] The open embedding

$$f_0| : (B^k - (1/2)B^k) \times T_0^n \times B^q \rightarrow W_0$$

defines by attachment a manifold

$$W'_1 \equiv (B^k - (1/2)B^k) \times T^n \times B^q \cup_{f_0|} W_0$$

and an open embedding

$$f'_1 : \text{domain } f_0 \cup (B^k - (1/2)B^k) \times T^n \times B^q \rightarrow W'_1.$$

Now use infinite s -cobordism theorem and capping off (Example 5) to get W_1, r_1 and f_1 and then get \dot{h} by the compact s -cobordism theorem [Details to be filled out here].

[Construction of s .] The preceding step produced a conelike retraction

$$r_1 h : (B^k \times T^n - (1/2)B^k \times p) \times B^q \rightarrow B^k \times T^n - (1/2)B^k \times p$$

which is standard projection near $\partial B^k \times T^n \times B^q$. Let s be the natural compactification of

$$\omega(r_1 h)(\omega^{-1} \times \text{id}_{B^q}) : (B^k \times T^n - (0, p)) \times B^q \rightarrow B^k \times T^n - (0, p)$$

where

$$\omega : B^k \times T^n - (1/2)B^k \times p \rightarrow B^k \times T^n - (0, p)$$

is a homeomorphism which is fixed near _____.

[Construction of S and R .] S is the unique covering cone-like retraction. R is defined by $jS(j \times \text{id})^{-1}$ on $j(B^k \times \mathbb{R}^n) \times B^q$, and is extended via the identity over all of $B^k \times \mathbb{R}^n \times B^q$. It is the crux of the torus device that R is continuous.

[Construction of F .] The left hand side of the diagram from top to bottom defines an open embedding

$$\phi : B^k \times 2\dot{B}^n \times B^q \rightarrow r^{-1}(B^k \times 2\dot{B}^n) \subset V$$

such that $r\phi = R|_{B^k \times 2\dot{B}^n \times B^q}$. Extend ϕ over _____ by f and then over all of $B^k \times \mathbb{R}^n \times B^q$ by engulfing, to get F . All the necessary homotopies for engulfing follow from the Homotopy Proposition (Prop. 3.1); recall the engulfing may be PL if desired, as $\text{int } V$ is PL triangulable. \square

6. PROOF OF EXISTENCE-UNIQUENESS THEOREM

This section proves Theorem 2.1, without the cone-like homotopy, but with the well-controlled ambient isotopy.

Sketch of Proof. Existence follows from a good uniqueness theorem; “good” means we want a relative C-D statement as in [EK, p.71]. This good uniqueness theorem follows in straightforward fashion from the Handle Straightening Theorem 5.1, much like the situation in [EK]. \square

7. LOCAL CONTRACTIBILITY OF THE SPACE OF CONE-LIKE RETRACTIONS;
CONE-LIKE HOMOTOPIES

This section is independent of the preceding Sections 2-6, and has no dimension restrictions. This section plays a role in this paper analogous to the role of the local contractibility of the homeomorphism group of a manifold ([Če], [EK]) in Siebenmann’s paper [Si₁].

Let M be a fixed manifold and V a fixed topological regular neighborhood of M , with distinguished submanifold $\delta V \subset \partial V$ but *without* a specific retraction. Let $C(V, M)$ be the space of all cone-like retractions $r : V \rightarrow M$ such that $r^{-1}(\partial M) = \delta V$, topologized with the majorant topology given by majorant maps on M . That is, given majorant map $\epsilon : M \rightarrow (0, \infty)$, the ϵ -neighborhood of $r : V \rightarrow M$ is

$$N(r, \epsilon) = \{p \in C(V, M) \mid d(p(x), r(x)) < \epsilon(r(x)) \text{ for all } x \in V\}$$

where d is the metric on M . Although $C(V, M)$ is decidedly non-metric if M is not compact, it turns out that $C(V, M)$ is closed under Cauchy limits if d is a complete metric (Compare [Si₁]); this fact is not so essential to us as the following facts.

Call a cone-like retraction $r : V \rightarrow M$ *locally approximable by bundle projections* (*locally approximable* for short) if each $x \in M$ has an open neighborhood W in M such that $r|_{r^{-1}(W)} : r^{-1}(W) \rightarrow M$ is arbitrarily closely approximable by disc bundle projections (uniformly, not majorantly). Let $C_0(V, M)$ denote the subset of $C(V, M)$ of all such locally approximable retractions. Of course, it is a corollary of Section 6 that $C_0(V, M) = C(V, M)$ if $\dim V \geq 6$; however, working with $C_0(V, M)$ obviates dimension restrictions.

The goal of this section is to show that $C_0(V, M)$ is locally 0-connected (defined below) and that a certain cone-like homotopy extension principle holds, analogous to the isotopy extension principle for homeomorphisms. Actually $C_0(V, M)$ is locally k -connected for all k by a routine adaptation of the Eilenberg-Wilder argument. The torus techniques for local contractibility fail us in this section so we turn to an adaptation _____

Proposition 7.1. (1) *Suppose $r \in C_0(V, M)$ and $U \approx \mathbb{R}^m$ or $U \approx \mathbb{R}_+^m$ is a coordinate chart in M . Then $r|_{r^{-1}(U)}$ is arbitrarily closely approximable by disc bundle projections (uniformly here).*

(2) *$C_0(V, M)$ is closed in $C(V, M)$. (As noted above $C(V, M)$ is closed in $P(V, M) =$ all proper maps $V \rightarrow M$, but we don’t need this).*

Theorem 7.2. *The local 0-connectivity (indeed locally k -connectivity) of $C_0(V, M)$, as mentioned above.*

Proof. This proof is accomplished by a limit argument, by first proving the “almost” local contractibility of the space of disc bundle projections. This is completely analogous to my proof by “almost handle straightening”, using Černavskii meshing, of the following result. \square

Theorem 7.3. (A) *Given any PL manifold M and $\epsilon > 0$, there exists $\delta > 0$ such that if $h : M \rightarrow M$ is a PL homeomorphism which is δ -close to the identity, then h may be PL ϵ -isotoped as close as desired to id_M (but not to id_M by counterexample of Kirby-Siebenman.). This process is canonical PL.*

(B) *(from (A).) The PL homeomorphism group of M is locally contractible as a topological group (but not as a semisimplicial complex).*

8. TOPOLOGICAL REGULAR NEIGHBORHOODS OF POLYHEDRA IN MANIFOLDS

This section sketches the extension of the previous sections to polyhedra in manifolds. There are two technical points that have to be sorted out before saying that the definitions of TRN’s routinely extend to polyhedra. The first concern is what is the polyhedral analogue of locally flat. The second concerns what to do at the boundary ∂V , for polyhedral pairs.

A faithful PL embedding $f : (X, Y) \rightarrow (Q, \partial Q)$ of a polyhedral pair into a PL manifold is *locally homotopically unknotted* if for each $x \in X$, both deleted links

$$\text{lk}(f(x), Q) - \text{lk}(f(x), f(X))$$

and (if $x \in Y$)

$$\text{lk}(f(x), \partial Q) - \text{lk}(f(x), f(Y))$$

have *free* π_1 (for each component). For codimension ≥ 3 this is always true as the π_1 ’s are trivial by general position. Note that for (X, Y) a codimension 2 manifold $(M, \partial M)$, this is just the usual local homotopy unknottedness definition.

A faithful topological embedding $f : (X, Y) \rightarrow (Q, \partial Q)$ of a polyhedral pair into a topological manifold is *locally tame* if for each $x \in X$ there is an open neighborhood $(U, \partial U)$ of $f(x)$ in $(Q, \partial Q)$ such that the embedding $f| : f^{-1}(U, \partial U) \rightarrow (U, \partial U)$ is PL locally unknotted for some PL manifold structure on $(U, \partial U)$. Note the PL structure on the source is induced from X , but the PL structures on the U ’s (for various x) need not be compatible. The unknottedness condition is independent of the PL structure on U .

In the definition of TRN’s for polyhedra one should replace “ $(M, \partial M)$ locally flat in $(V, \partial V)$ ” with “ (X, Y) locally tame in $(V, \partial V)$ ”.

There is another change required in case $Y \neq \emptyset$, because the condition that $r^{-1}(Y)$ be a TRN of Y is too restrictive, as the following example shows.

Example 6. *Let X be an interval, Y the midpoint of X , and $(V, \partial V) = (2\text{-disc}, \text{boundary})$ as shown. Then $r^{-1}(Y)$ must be disconnected.*

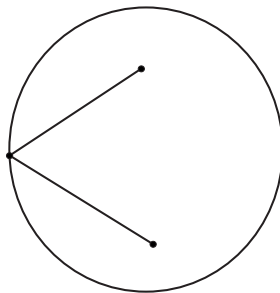

This same problem cropped up in [E₁] and the remedy is the same—namely to not require δV to be all of $r^{-1}(Y)$. Details are trivial.

Having established these two technical points, then the definition of TRN’s (either mapping cylinder or cone-like) for polyhedra in manifolds is as indicated.

Theorem 8.1. *Existence-Uniqueness holds exactly as in the manifold case (with the same dimension restrictions on Q).*

Perhaps the quickest proof of this is by analogy:

$$\frac{\text{This proof}}{\text{Proof of Th. 2.1}} \approx \frac{\text{Siebenmann’s [Si}_2\text{]}}{\text{Edwards-Kirby’s [EK]}}$$

That is, the extension to the above theorem of the proofs in §5 and §6 is completely analogous to the extension to locally cone-like TOP stratified sets of the local contractibility of the homeomorphism group of a topological manifold, done by Siebenmann.

The local unknottedness hypothesis ensures that the s -cobordism theorem holds at all applications. Details omitted here.

Replace CW complex by cell complex (i.e. don’t need skeletal filtration that CW complexes have).

9. CW COMPLEXES

Remark 7. *In the following, one may replace ‘CW complex’ with ‘cell complex’. In particular, one doesn’t need the skeletal filtration present in CW complexes.*

It turns out the CW complexes in manifolds have topological regular neighborhoods *stably*, that is, $X \subset Q$ has a topological regular neighborhood in $Q \times \mathbb{R}^s$ for some $s \geq 0$. Furthermore they are unique nonstably. The most useful application of these facts seems to be a proof that a CE map (\equiv proper cell-like surjection) of CW complexes is a simple homotopy equivalence (first proved for homeomorphisms by Chapman [Ch]). Our discussion below is toward this goal.

All our CW complexes from now on are *finite* (i.e., compact). This discussion trivially generalizes to nonfinite CW complexes of finite dimension, but we postpone details for arbitrary CW complexes.

Either definition of topological regular neighborhood given at the start of the paper is valid with M replaced by a CW complex X , subject to certain provisos. For the

mapping cylinder definition, they are: regard $\partial X = \emptyset = \delta V$ always; replace “locally flat” by “each \dot{F}_x is 1-UV”, and always assume $\dim X \leq \dim V - 3$. For the second definition, the provisos are the same, except that “locally flat” is replaced by “ X is 1-LCC in V ”, that is, $V - X$ is 1-LC at X . This implies each \dot{F}_x is 1-UV, and in the presence of mapping cylinder structure, the conditions are equivalent.

Remark 8. *If M_f is a mapping cylinder for some proper map $f : A \rightarrow B$, then $M_f \times I^k$ (with $I^k = [-1, 1]^k$) has a natural mapping cylinder structure for the map*

$$(f \times \pi)| : (A \times I^k \cup M_f \times \partial I^k) \rightarrow B \times 0 = B$$

where $\pi : I^k \rightarrow 0$ is projection, as suggested by the diagram. The new fibers $\{F_b \times I^k\}$ have UV^{k-1} boundaries

$$\{(F_b \times I^k)^\cdot = \dot{F}_b \times I^k \cup F_b \times \partial I^k\},$$

regardless of the nature of F_b , because $(F_b \times I^k)^\cdot$ has the shape of $\Sigma^{k-1} \dot{F}_b$.

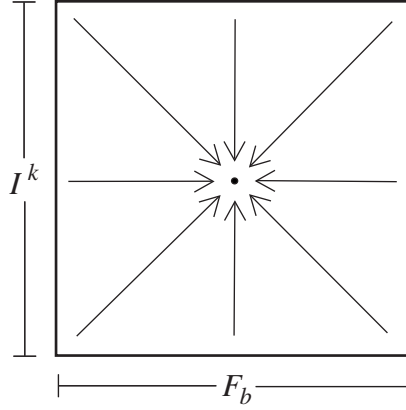

Theorem 9.1. *If V is any abstract TRN of CW complex X , as defined above, then $X \hookrightarrow V$ is a simple homotopy equivalence.*

Theorem 9.2. *Suppose $X \subset Q$ is a CW complex embedded in a topological manifold, $\partial Q = \emptyset$. Then*

- (1) (Existence) X has a mapping cylinder TRN in $Q \times \mathbb{R}^s$ for some $s \geq 0$, and
- (2) (Uniqueness) If V_0 and V_1 are two TRN's of X in Q , then V_0 is homeomorphic to V_1 by ambient isotopy of Q which fixes a neighborhood of X .

Corollary 9.3 (to Theorem 9.1 and Part 1 of Theorem 9.2). *A homeomorphism $h : X \rightarrow Y$ of CW complexes is a simple homotopy equivalence.*

Proof of Corollary. Let V be a TRN of Y , by Theorem 2. Then Theorem 1 says that both the inclusion $\eta : Y \rightarrow V$ and the embedding $\eta h : X \rightarrow V$ are simple homotopy equivalences, hence so is h . \square

Proof of Theorem 9.1. This is just an extension to CW complexes of an argument in [E₂]. One inducts on the number of cells in X , and uses TRN uniqueness to accomplish the splitting of V over $S^{n-1} \times 0$ in $S^{n-1} \times (-1, 1) =$ open collar neighborhood of ∞ in the last open cell of X . Once V is split, one applies induction and the Sum Theorem. \square

Proof of Theorem 9.2. (Uniqueness). Pull V_0 into $\text{int } V_1$ by engulfing, and then apply the s -cobordism theorem to the difference $V_1 - \text{int } V_0$. It is an s -cobordism because $V_0 \subset V_1$ is a simple homotopy equivalence, and throwing away $\text{int } V_0$ with its codimension ≥ 3 spine does not change this.

(Existence) Interestingly, the proof has nothing to do with the previous theory; it is just a straightforward inductive exercise.

We first remark that in the following construction, the advantage of always working in the ambient manifold $Q \times \mathbb{R}^s$ (even if $Q = \mathbb{R}^q$), rather than constructing V in the abstract, is that it automatically provides the correct framing for the normal bundle of the embedding $g_\partial : \partial D^n \rightarrow \partial(V \times B^n)$ (defined below) which is used to attach the handle. If one didn't choose this framing correctly, some future g_∂ might not have a framing. Thus, working in Q obviates paying attention to bundle trivializations.

Suppose Y is a CW complex with mapping cylinder TRN $r : V \rightarrow Y$, where V is a collared, codim 0 submanifold of Q . Suppose $X = Y \cup_{f|_{\partial D^n}} f(D^n) \subset Q$ where $f : D^n \rightarrow Q$ is such that $f(D^n) \cap Y = f(\partial D^n)$ and $f|_{\text{int } D^n}$ is an embedding. Define $g_\partial : \partial D^n \rightarrow \text{int } V \times \partial B^n \subset \partial(V \times B^n)$ by $g_\partial(x) = (f(x), x)$ (recall $D^n = B^n$); it is a locally flat embedding. Let

$$F = \{\lambda g_\partial(x) \mid x \in \partial D^n, 0 \leq \lambda \leq 1\} \subset V \times B^n$$

be the submapping cylinder of the natural map $g_\partial(\partial D^n) \rightarrow f(\partial D^n) \subset Y$, where the fibers $\{\lambda_w\}$ are those of the natural mapping cylinder retraction $r_1 : V \times B^n \rightarrow Y$.

Let $g : D^n \rightarrow Q \times \mathbb{R}^n - \text{int}(V \times B^n)$ be a locally flat embedding extending g_∂ , such that g is homotopic to f in $V \times \mathbb{R}^n$ by a homotopy which agrees in ∂D^n with the straight line homotopy in F joining g_∂ to $f|_{\partial D^n}$. Then $X' \equiv Y \cup F \cup g(D^n)$ is homeomorphic to X by the restriction $h| : X' \rightarrow X$ of a homeomorphism $h : Q \times \mathbb{R}^n \rightarrow Q \times \mathbb{R}^n$ (since homotopy yields isotopy in the trivial range). Thus it suffices to construct a TRN V' for X' in $Q \times \mathbb{R}^n$.

Let $(H, \delta H)$ be the total space of a normal disc bundle for $(g(D^n), g(\partial D^n))$ in $(Q \times \mathbb{R}^n - \text{int}(V \times B^n), \partial(V \times B^n))$. Then $(H, \delta H) \approx (g(D^n), g(\partial D^n)) \times B^q$. Define $V' = V \times B^n \cup_{\delta H} H$. We can define mapping cylinder retraction $r' : V' \rightarrow X'$ by adjusting the mapping cylinder retraction $r_1 : V \times B^n \rightarrow Y$ to "turn the corner" near F , and then extending over H , as follows. Let $r'_1 : V \times B^n \rightarrow Y \cup F$ be the mapping cylinder retraction obtained from r_1 as suggested by the following figure (note the identifications made on the bottom of the rectangles are compatible with the indicated projections.)

In particular, $r'_1| : \delta H \rightarrow g(\partial D^n)$ is standard projection, so r'_1 extends, using standard projection $H \rightarrow g(D^n)$, to a retraction $r' : V' \rightarrow X'$. Clearly r' is a

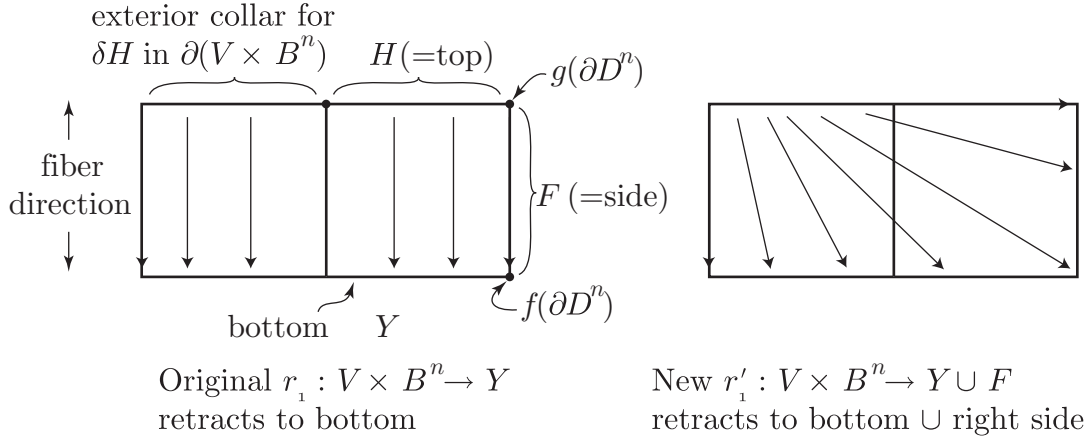

mapping cylinder retraction, and the 1-UV property follows because X' is 1-LCC in V' .

There is an interesting alternative way of defining $r' : V' \rightarrow X'$, observed by Siebenmann. Let $p_1 : V' \rightarrow V \times B^n \cup g(D^n)$ be the extension-via-the-identity of some natural relative mapping cylinder retraction $p_0 : H \rightarrow \delta H \cup g(D^n)$ and let $p_2 : V \times B^n \cup g(D^n) \rightarrow X'$ (**not** a retraction but a natural extension of $r_1 : V \times B^n \rightarrow Y$ such that $p_2|_{g(\text{int } D^n)} \rightarrow X' - Y$ is a homeomorphism. Then $p = p_2 p_1 : V' \rightarrow X'$ is a CE map which restricts in X' to a CE map $p| : X' \rightarrow X'$. In the usual fashion, let $q : V' \rightarrow V'$, with $q|_{\partial V'} = \text{id}$, be a map which is a homeomorphism off F , such that $q|_{X'} = p|_{X'}$. Then $r' \equiv p q^{-1} : V' \rightarrow X'$ is a well-defined mapping cylinder retraction. \square

10. CONCERNING MAPPING CYLINDER NEIGHBORHOODS OF OTHER COMPACTA

Consider the following wildly optimistic

Every compact ENR (= euclidean neighborhood retract) $X \subset \mathbb{R}^n$, with $\dim X \leq n - 3$ and $\mathbb{R}^n - X$ 1-LC at X , has a manifold mapping cylinder neighborhood which is unique up to homeomorphism. Or at least, every such X has such a unique neighborhood stably, in some \mathbb{R}^{n+p} . (This conjecture has a natural Hilbert cube version for compact ANR's).

This conjecture is stronger than Borsuk's question (the finite dimensional version) of whether compact ENR's have finite homotopy type; equivalent to Borsuk's question is whether such X as above have radial neighborhoods in \mathbb{R}^n or even \mathbb{R}^{n+p} (recall U is radial if $U - X \approx Y \times \mathbb{R}^1$ for some compactum. (See [Si₃] for best known implications). Incidentally, the easiest way to prove the implication: X has finite type $\Rightarrow X$ has a radial neighborhood stably, is to use the following readily proved stable version of Geogehan-Summerhill [GS]: two compact subsets X and Y of \mathbb{R}^n have the same (Borsuk) shape \Leftrightarrow the quotients $\mathbb{R}^{2n+2}/X \approx \mathbb{R}^{2n+2}/Y$ are homeomorphic.

If the conjecture above is true, it would imply that all such X are CE images of manifolds. It is known conversely that any finite dimensional CE image of a manifold is an ENR. And such an ENR does have a mapping cylinder neighborhood stably,

namely a quotient of one for the source manifold stabilized, via the decomposition argument of [Sh].

It is interesting to compare the Conjecture to two questions raised by Chapman in the Proceedings of the 1973 Georgia Topology Conference. These are finite dimensional versions. Let X be a compact ENR and K, L finite cell complexes.

Question 1. *If $f : K \rightarrow X$ and $g : L \rightarrow X$ are CE mappings, does there exist a simple homotopy equivalence $h : K \rightarrow L$ such that $gh \sim f$?*

Question 2. *If $f : X \rightarrow K$ and $g : X \rightarrow L$ are CE mappings, does there exist a simple homotopy equivalence $h : K \rightarrow L$ such that $hf \sim g$?*

The answer to Question 1 is yes if the stable *uniqueness* part of the Conjecture is true; the answer to Question 2 is yes if the stable *existence* part of the Conjecture is true.

11. Appendix: AN EXTENSION OF SOME WELL KNOWN HOMOTOPY THEOREMS

This appendix presents a useful generalization of the familiar Whitehead theorem for weak homotopy equivalences. Using an elementary shape theory definition, the Theorem encompasses Whitehead's Theorem on the one hand ($Z = \text{point}$), and the Lacher-Kozłowski-Price-_____ Theorem for cell-like mappings on the other hand, in addition to having applications in between.

We work in the category of locally compact metric ANR's and proper maps (whose point universes need **not** be ANR's).

A map $f : X \rightarrow Y$ of compact metric spaces (*not* necessarily ANR's) is a *k-shape equivalence* if both X and Y have finitely many components and f induces isomorphisms on the homotopy groups up through dimension k . As these homotopy groups are awkward inverse limits, we give the definition in primitive form (assuming X and Y connected; otherwise make it hold componentwise). If $X \hookrightarrow L$ and $Y \hookrightarrow M$ are embedded as subsets of ANR's L and M and if U_X and U_Y are arbitrary neighborhoods then there are smaller neighborhoods $V_X \subset U_X$ and $V_Y \subset U_Y$ and a map $F : V_X \rightarrow V_Y$ extending $P : X \rightarrow Y$, such that for any i , $0 \leq i \leq k$:

- *injectivity*: for any map $\alpha : S^i \rightarrow V_X$ if $F\alpha \sim 0$ in U_Y , then $\alpha \sim 0$ in U_X , and
- *surjectivity*: for any map $\beta : S^i \rightarrow V_Y$, there is a map $\alpha : S^i \rightarrow V_X$ such that $F\alpha \sim \beta$ in U_Y . Surjectivity can in fact be accomplished by homotopy rel basepoint, as a consequence of π_1 surjectivity.

As usual in shape theory, this definition holds for any pair of embeddings of X and Y into ANR's if it holds for one pair.

Some authors would define a *k-shape equivalence* as being only surjective in dimension k (e.g. [Sp, p.404], [Ko]) and would prove the following theorem with $\dim J \leq k$ and $J = K$. However, it seems that for applications, the form we state it in is perhaps more natural.

If $f : X \rightarrow Y$ is a map and $p : Y \rightarrow Z$ is a surjection, then f is a *k-shape equivalence over Z* if for each $z \in Z$, $f| : f^{-1}(p^{-1}(z)) \rightarrow p^{-1}(z)$ is a *k-shape equivalence*.

Note. In the following, [proper] means "proper" is optional. The theorem and corollary are most believable with proper in place. In fact, on page 30, I haven't defined *k-shape equivalent* for non-compact spaces.

Theorem 11.1 (Compare [Sp, p.404, Th.22] and [Ko]). *Suppose $f : X \rightarrow Y$ is a [proper] map of locally compact metric ANR's and $p : Y \rightarrow Z$ is a surjection to a separable metric space Z . Suppose f is a *k-shape equivalence*. In the diagram below, suppose J is an arbitrary simplicial complex, $\dim J \leq k + 1$, with subcomplex L , and $g : L \rightarrow X$ and $h : J \rightarrow Y$ are maps which make the diagram commute.*

Given any majorant map $\epsilon : Z \rightarrow (0, \infty)$, there exists a lift $g' : J \rightarrow X$ extending g such that $pf'g'$ is ϵ -close to ph . Furthermore, if K is a subcomplex of J with $\dim K \leq k$ then $f'g'|_K$ may be assumed (p, ϵ) -homotopic to $h|_K$.

$$\begin{array}{ccc}
 L & \xrightarrow{g} & X \\
 \downarrow & \nearrow g' & \downarrow f \\
 J & \xrightarrow{h} & Y \\
 & & \downarrow p \\
 & & Z
 \end{array}$$

Proof. Standard lifting argument. □

The following Corollary encompasses several well-known theorems.

Corollary 11.2. *Suppose $f : X \rightarrow Y$ is a [proper] map of locally compact metric ANR's such that for some k ,*

- (1) $\dim X \leq k$ and $\dim Y \leq k$, and
- (2) f is a k -shape equivalence over Z for some proper surjection $p : Y \rightarrow Z$.

Then f is a [proper] homotopy equivalence. In fact, there is a [proper] homotopy inverse $g : Y \rightarrow X$ such that $fg \sim \text{id}_Y$ by an arbitrarily p -small homotopy, and $gf \sim \text{id}_X$ by an arbitrarily pf -small homotopy.

Proof. *Routine mapping cylinder-nerve argument.*

Part II.

12. ADDITIONAL TOPICS

This part is not yet written. Topics to include: neighborhoods of a pair, neighborhoods by restriction, Lickorish-Siebenmann Theorem for TRN's, transversality (with discussion of Hudson's example), the group TOP.

REFERENCES

[BS] B.J. Ball and R.B. Sher, *A theory of proper shape for locally compact metric spaces*, Fund. Math. 86 (1974), 163–192.

[Bro] M. Brown, *Locally flat imbeddings of topological manifolds*,. Ann. of Math. (2) 75 (1962) 331–341.

[Bry] J.L. Bryant, *On embeddings of compacta in Euclidean space*, Proc. Amer. Math. Soc. 23 (1969) 46–51.

- [BrS] J.L. Bryant and C.L. Seebeck, III, *Locally nice embeddings in codimension three*, Quart. J. Math. Oxford Ser. (2) 21 1970 265–272.
- [Če] A.V. Černavskii, *Local contractibility of the group of homeomorphisms of a manifold*, (Russian) Mat. Sb. (N.S.) 79 (121) 1969 307–356.
- [Ch] T.A. Chapman, *Topological invariance of Whitehead torsion*, Amer. J. Math. 96 (1974), 488–497.
- [Co₁] M. Cohen, *Simplicial structures and transverse cellularity*, Annals of Math 85 (1967), 218–24.
- [Co₂] ———, *A general theory of relative regular neighborhoods*, TAMS (136) 1969, 189–229.
- [E₁] R. Edwards, *The equivalence of close piecewise linear embeddings*. General Topol. Appl. 5 (1975), 147–180.
- [E₂] ———, *On the topological invariance of simple homotopy type for polyhedra*. Amer. J. Math. 100 (1978), no. 4, 667–683.
- [EG] R. Edwards and L.C. Glaser, *A method for shrinking decompositions of certain manifolds*, TAMS (165) 1972.
- [EK] R. Edwards and R. Kirby, *Deformations of spaces of embeddings*, Annals of Math 93 (1971), 63–8.
- [GS] R. Geoghegan and R. Summerhill, *Concerning the shapes of finite-dimensional compacta*, Trans. Amer. Math. Soc. 179 (1973), 281–292.
- [Gl] L.C. Glaser, *On double suspensions of arbitrary nonsimply connected homology n -spheres*. Topology of manifolds (Proc. Inst., Univ. Georgia, Athens, Ga., 1969), pp. 5–17. Markham, Chicago, Ill., 1970.
- [KS] R. Kirby and L. Siebenmann, *Foundational essays on topological manifolds, smoothings, and triangulations. With notes by John Milnor and Michael Atiyah*. Annals of Mathematics Studies, No. 88. Princeton University Press, Princeton, N.J.; University of Tokyo Press, Tokyo, 1977. vii+355 pp.
- [Ko] G. Kozłowski, *Factorization of certain maps up to homotopy*, Proc. Amer. Math. Soc. 21 1969 88–92.
- [Jo] F.E.A. Johnson, *Lefschetz duality and topological tubular neighbourhoods*. Trans. Amer. Math. Soc. 172 (1972), 95–110.
- [La] R.C. Lacher, *Cell-like mappings I, II*, Pacific Jour. Math 30 (1969), 717–731
35 (1970), 649–660.
- [La₂] R.C. Lacher, *Cell-like mappings of ANR's*, Bull. Amer. Math. Soc. 74 1968 933–935.
- [RS_I] C.P. Rourke and B.J. Sanderson, *Block bundles. I*. Ann. of Math. (2) 87 1968 1–28.
- [RS_{II}] ———, *Block bundles. II. Transversality*. Ann. of Math. (2) 87 1968 256–278.
- [RS_{III}] ———, *Block bundles. III. Homotopy theory*. Ann. of Math. (2) 87 1968 431–483.
- [RS₄] ———, *On topological neighbourhoods*. Compositio Math. 22 (1970), 387–424.
- [Sh] R.B. Sher, *Realizing cell-like maps in Euclidean space*, General Topology and Appl. 2 (1972), 75–89.
- [Si₁] L. Siebenmann, *Approximating cellular maps by homeomorphisms*, Topology 11 (1972), 271–294.
- [Si₂] ———, *Deformation of homeomorphisms on stratified sets*, Comment. Math. Helv. 47 (1972), 123–163.
- [Si₃] ———, *Open regular (or canonical) neighborhoods*, General Topology and Appl. 3 (1973), 51–61.

- [Si₄] _____, *Disruption of low-dimensional handlebody theory by Rohlin's theorem*, 1970 *Topology of Manifolds* (Proc. Inst., Univ. of Georgia, Athens, Ga., 1969) pp. 57–76 Markham, Chicago, Ill.
- [Sp] E.H. Spanier, *Algebraic topology*,. McGraw-Hill Book Co., New York-Toronto, Ont.-London 1966 xiv+528 pp.
- [St] R.J. Stern, *Stability implies normal and disc bundles*, *Bull. Amer. Math. Soc.* 79 (1973), 133–135.
- [Wa] C.T.C. Wall, *Surgery on compact manifolds*, London Mathematical Society Monographs, No. 1. Academic Press, London-New York, 1970. x+280 pp.

DEPARTMENT OF MATHEMATICS, UNIVERSITY OF CALIFORNIA, LOS ANGELES,
E-mail address: `rde@math.ucla.edu`