

TRAK_{TM} 2^{OP} M11 Mill ProtoTRAK[®] TMX CNC

Safety, Programming, Operating and Care Manual

Document:	P/N 28171
Version:	081618

TRAK MACHINE TOOLS



SOUTHWESTERN INDUSTRIES, INC.

2615 Homestead Place
Rancho Dominguez, CA 90220-5610 USA
T | 310.608.4422 | F | 310.764.2668
Service Department: 800.367.3165

e-mail: sales@trakmt.com | service@trakmt.com | web: www.trakmt.com

Copyright © 2018, Southwestern Industries, Inc. All rights are reserved. No part of this publication may be reproduced, stored in a retrieval system, or transmitted, in any form or by any means, mechanical, photocopying, recording or otherwise, without the prior written permission of Southwestern Industries, Inc.

While every effort has been made to include all the information required for the purposes of this guide, Southwestern Industries, Inc. assumes no responsibility for inaccuracies or omission and accepts no liability for damages resulting from the use of the information contained in this guide. All brand names and products are trademarks or registered trademarks of their respective holder.

Table of Contents

1.0 Introduction	1
2.0 Safety	2
2.1 Safety Publications.....	2
2.2 Danger, Warning, Caution, and Note Labels & Notices As Used In This Manual.....	2
2.3 Safety Precautions.....	8
3.0 TRAK 2^{OP} Description	10
3.1 Machine Specifications.....	10
3.2 Maximum Spindle Torque and Horsepower.....	12
3.3 ProtoTRAK TMX Control Hardware.....	14
3.4 Machine Major Subassemblies.....	16
3.5 TRAK 2 ^{OP} Options.....	21
4.0 Basic Operations	24
4.1 Power On.....	24
4.2 Power Off.....	24
4.3 Moving the 2 ^{OP} Mill Around the Shop.....	24
4.4 Modes.....	25
4.5 Emergency Stop.....	25
4.6 ProtoTRAK TMX Start Screen.....	26
4.7 Manual Operation.....	26
4.8 Electronic Handwheel.....	26
4.9 Moving Tools In and Out of the Spindle.....	27
4.10 Service Codes.....	27
5.0 Definitions, Terms & Concepts	28
5.1 ProtoTRAK TMX Axis Conventions.....	28
5.2 Absolute & Incremental Reference.....	28
5.3 Referenced and Non-Referenced Data.....	29
5.4 Tool Diameter Compensation.....	29
5.5 Connective Events.....	30
5.6 Conrad.....	30
5.7 Memory and Storage.....	31

6.0 DRO Mode	32
6.1 Hard Keys in DRO Mode	32
6.2 Soft Keys in DRO Mode	32
6.3 The ProtoTRAK TMX Screen in DRO Mode.....	33
6.4 The Electronic Handwheel.....	33
6.5 Manual Operation in DRO Mode	33
6.6 Moves to Reference Positions	34
7.0 Program Mode.....	35
7.1 Enter Program Mode, Assign a Program Name, Enter Ball Lock Locations and Turn Indexer Prompts On	35
7.2 Programming Strategy and Procedures	36
7.3 Programming Events	37
7.4 Soft Keys and Prompts Used to Define the Events	40
7.5 Assumed Tool Offset, Feedrate, and Tool #.....	42
7.6 Incremental Reference Position	42
7.7 Finish Cuts	43
7.8 SMX/PMX Program Events	43
8.0 Changing or Correcting Programs	44
8.1 Deleting a Partially Programmed Event.....	44
8.2 Editing Data while Programming an Event	44
8.3 Changing the Feedrate.....	44
8.4 Changing a Part Number (Making a Copy of a Program)	44
8.5 Saving Changes to a Program	44
8.6 Erasing an Entire Program	45
8.7 G-Code Editor	45
9.0 Set-Up Mode.....	47
9.1 Soft Keys in Set-Up Mode	47
9.2 Working with Tools	48
9.3 Setting Tool Lengths	48
9.4 Loading and Unloading Tools.....	49
10.0 Run Mode	52
10.1 Run Mode Checklist	52
10.2 TRAKing™	52
10.3 Soft Keys in Run Mode.....	52

10.4	Overrides	52
11.0	Programming In/Out Mode	53
11.1	Cautions about Opening and Deleting Programs and Tool Table Functionality When Opening Programs	53
11.2	Program Formats and Labeling	54
11.3	Soft Keys in Program In/Out Mode	58
11.4	File Transfer and Backup	58
11.5	Networking	59

1.0 Introduction

Congratulations on your purchase of the TRAK 2^{OP} featuring the ProtoTRAK TMX CNC.

The TRAK 2^{OP} is a brand new approach to machining, by bringing together capacity, portability, capability and ease of use to a degree never seen before. With the TRAK 2^{OP}, your shop can turn wasted labor into high value output when and where that labor becomes available.

In order for the TRAK 2^{OP} to fulfill its purpose, it must be easy to use. Easy to use means as few buttons, commands, prompts and features as possible – only what is absolutely needed in order to be useful as a true second operation machine. The design of the product has at all times been held to this principle.

This manual is as easy to read as the TRAK 2^{OP} is to use. It provides only the essential information that is not obvious or dealt with by the on screen instructions. Everyone who will run the TRAK 2^{OP} can quickly get the information they need to run their parts safely and effectively.

2.0 Safety

The safe operation of the TRAK 2^{OP} depends on its proper use and the precautions taken by each operator.

- Read and study this manual and the TRAK 2^{OP} Programming, Operating, and Care Manual. Be certain every operator understands the operation and safety requirements of this machine *before* its use.
- Never run the machine with enclosure doors open
- Always wear safety glasses and safety shoes.
- Always stop the spindle and check to ensure the CNC control is in the stop mode before changing or adjusting the tool or workpiece.
- Never wear gloves, rings, watches, long sleeves, neckties, jewelry, or other loose items when operating or around the machine.
- Use adequate point of operation safeguarding. It is the responsibility of the employer to provide and ensure point of operation safeguarding per OSHA 1910.212 - Machining centers.

2.1 Safety Publications

Refer to and study the following publications for assistance in enhancing the safe use of this machine.

Safety Requirements for Machining Centers and Automatic, Numerically Controlled Milling, Drilling and Boring Machines (ANSI B11.22-2002) (R2007) & (ANSI B11.23-2002) (R2007). Available from The American National Standards Institute, 1819 L Street N.W., Washington D.C. 20036

Concepts And Techniques Of Machine Safeguarding (OSHA Publication Number 3067). Available from The Publication Office - O.S.H.A., U.S. Department of Labor, 200 Constitution Avenue, NW, Washington, DC 0210.

2.2 Danger, Warning, Caution, and Note Labels & Notices As Used In This Manual

DANGER - Immediate hazards that **will** result in severe personal injury or death. Danger labels on the machine are red in color.

WARNING - Hazards or unsafe practices that *could* result in severe personal injury and/or damage to the equipment. Warning labels on the machine are orange in color.

CAUTION - Hazards or unsafe practices, which *could* result in minor personal injury or equipment/product damage. Caution labels on the machine are yellow in color.

NOTE - Call attention to specific issues requiring special attention or understanding.

Safety & Information Labels Used On The TRAK 2^{OP} Milling Machine



It is forbidden by OSHA regulations and by law to deface, destroy or remove any of these labels

SAFETY INSTRUCTIONS

1. Read and understand the Operator's Manual and all warnings on this sign before operating machine.
2. Machine should only be operated by qualified personnel that have been trained in the operation and use of this machine.
3. Machine starts and moves automatically. Never place any part of your body near or on moving parts of this machine.
4. Stop spindle completely before touching the tool, work piece, or spindle.
5. Do not operate machine unless all guards, interlocks, and safety devices are installed and functioning.
6. Always clamp work piece and tool securely. Avoid excessive feeds and spindle speeds.
7. Wear safety glasses, shoes, and hearing protection when operating machine.
8. Remove rings, watches, jewelry and loose fitting clothes. Keep hair away from moving parts of the machine.
9. Installation and service must be performed by qualified personnel only, following instructions in the Maintenance Manual. Turn off and lock-out the power at the main electrical panel before servicing.
10. It is the responsibility of the user to be sure that this machine is in safe operating condition at all times, and that the operator follows the safe operating procedures described in the Operator and Maintenance Manuals.

Do not remove or disfigure this sign.

SAFETY WARNING!

1. Hazardous voltage present in the electrical equipment of this machine. Only qualified engineers are allowed to install, test, adjust or maintain it.
2. Isolate power before install, test, adjust or maintain the electrical equipment of this machine.
3. Do Not turn on the power before the protective grounding has been securely connected.
4. Do Not change any device of this machine without permission.
5. Residual, hazardous voltages remain after the power is disconnected. Wait 10 minutes after removal of power before undertaking any work on the electrical equipment of this machine.

**FAILURE TO COMPLY WITH THE ABOVE
MAY RESULT IN A SERIOUS ACCIDENT**

S-S1071

WARNING



1. Never open door during operation.
2. Do not operate with door removed.

Failure to observe the above may result in serious injury.

S-S3120

WARNING

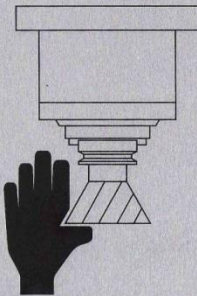

Keep hands, clothing and body clear of rotating spindle. Machine starts and moves automatically. Can cause severe injury.

1. Set control in manual mode before working near spindle.
2. Isolate machine before servicing.

S-S3010

<p>WARNING</p> <ol style="list-style-type: none"> 1. IMPROPER OPERATION OR IMPROPER MAINTENANCE OF THIS MACHINE MAY CAUSE SERIOUS BODILY INJURY OR DEATH. 2. DO NOT OPERATE THIS MACHINE UNTIL YOU HAVE RECEIVED OPERATING AND SAFETY INSTRUCTIONS FROM YOUR EMPLOYER. 3. FOLLOW ALL SAFETY PRACTICES PRESCRIBED BY YOUR EMPLOYER AND AS OUTLINED IN THE "PROGRAMMING, OPERATION AND CARE MANUAL". 4. IT IS THE RESPONSIBILITY OF THE EMPLOYER TO PROVIDE AND ENSURE POINT OF SAFEGUARDING PER ANSI B11.22-2002 & B11.23-2002 5. THE MANUFACTURER IS NOT LIABLE (RESPONSIBLE) FOR ANY DAMAGE OR INJURY OF ANY KIND TO PERSONS OR PROPERTY CAUSED BY OR RESULTING FROM THE IMPROPER OR UNAUTHORIZED USE, OPERATION, MAINTENANCE, ALTERATION, MODIFICATION, CHANGE IN CONFIGURATION OF THIS MACHINE OR ANY OF ITS COMPONENTS, PARTS, OR THE USE OF THIS UNIT WITH ANY THIRD PARTY ACCESSORIES OR PARTS. <p>DO NOT REMOVE THIS SIGN FROM MACHINE</p>	<p>WARNING</p> <p>THIS COUNTERBALANCE CYLINDER STAYS PRESSURIZED EVEN IF THE MAIN AIR IS DISCONNECTED. BEFORE DISCONNECTING THIS CYLINDER, FIRST DISCONNECT THE MAIN AIR SUPPLY, LOWER THE FRONT DOOR ALL THE WAY DOWN, THEN RELEASE ALL AIR PRESSURE FROM THE AIR STORAGE TANK INSIDE THE MACHINE BY SLOWLY OPENING THE DRAIN VALVE LOCATED ON THE BOTTOM OF THE TANK.</p> <p>CAUTION! IN ADDITION TO THE COMPRESSED AIR, THIS TANK MAY ALSO CONTAIN SOME OIL AND WATER. USE PROPER EYE PROTECTION AND EXERCISE CAUTION WHEN OPENING THE DRAIN VALVE.</p>
---	---

WARNING: PRESSURIZED VESSEL

THIS AIR TANK STAYS PRESSURIZED EVEN IF THE MAIN AIR IS DISCONNECTED. BEFORE DISCONNECTING THIS TANK, FIRST DISCONNECT THE MAIN AIR SUPPLY, LOWER THE FRONT DOOR ALL THE WAY DOWN, THEN RELEASE ALL AIR PRESSURE FROM THE TANK BY SLOWLY OPENING THE DRAIN VALVE LOCATED ON THE BOTTOM OF THE TANK.

CAUTION!
IN ADDITION TO THE COMPRESSED AIR, THIS TANK MAY CONTAIN SOME OIL AND WATER. USE PROPER EYE PROTECTION AND EXERCISE CAUTION WHEN OPENING THE DRAIN VALVE.

WISE & FIXTURE WARNING

Vise or fixture must not protrude beyond the back edge of the worktable to avoid collision with the ATC. It may not protrude more than 1.5 inches beyond the front of the worktable to avoid collision with the front door. Use SWI modified Kurt vise P/N VISE-2OPM10 or Kurt vise 3600V-INT or equivalent.

FRONT

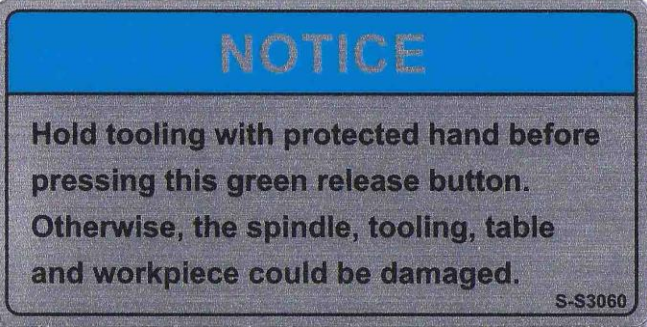

MAINTENANCE SCHEDULE

DAILY

- Remove majority of chips from around the axis slide ways, work table and way covers, especially between table and ATC.
- Empty chip tray.
- Visually check lubrication pump oil level and make sure it is always above the minimum line.
- Visually check the coolant level and add if it is low.
- Visually check the air regulator filter.

MONTHLY OR AS SPECIFIED

- Remove rear ATC and Y-axis motor compartment access covers and clean chips and other debris. Cleanup any oil or coolant accumulated on the bottom panel of the machine base.
- Visually inspect the condition of way and ball screw covers. Clean if showing chip build up.
- Check and if needed replace the air regulator filter element.
- Every two months drain and remove the coolant tank and clean inside, including pump screen. Fill with new coolant.
- Visually check the tool unclamp oil reservoir level.
- Remove all air filters in the electrical cabinet and transformer enclosure every two months and clean.

YEARLY

- Remove all covers. Vacuum chips, debris, and wipe down machine from top to bottom.
- Check backlash on each axis and adjust if needed. Refer to the machine manual for more information.
- Inspect machine for any unusual wear and play.
- Check cables and pneumatic lines for any excessive abrasions or cuts.
- Inspect the ATC air cylinder and grease the ATC linear rail bearing blocks.
- Please contact SWI Service Dept. for help with any machine maintenance procedures. Service Dept. contact number is 1-800-367-3165.

i27694-20

MACHINE MOVING INSTRUCTIONS

1. Read and understand the Moving Instructions in the Operator Manual before moving the machine.
2. Moving path must be flat, smooth, stable, and clear.
3. Move X-axis to center, Y-axis to the front, Z-axis down.
4. Close the front door. Never push or pull machine with door handle
5. Turn off power and disconnect the power cord, compressed air hose, and any other cables.
6. For front or rear pickup: roll (SWI provided or approved) pallet jack as far as possible under the machine. Pallet jack must support front and rear structural cross-members of the base casting.
For Right or Left side pickup: center pallet jack and roll under as far as possible.
7. Lift machine 1/2-3/4 inch (12-20 mm) off the floor.
8. Pull pallet jack to move the machine to new location.
9. Slowly lower machine.
10. Reconnect electrical power, air hose, etc.
11. Power up machine and check tram. Adjust machine leveling feet to achieve desired tram (See Operator Manual Instructions). All 4 legs must touch floor.

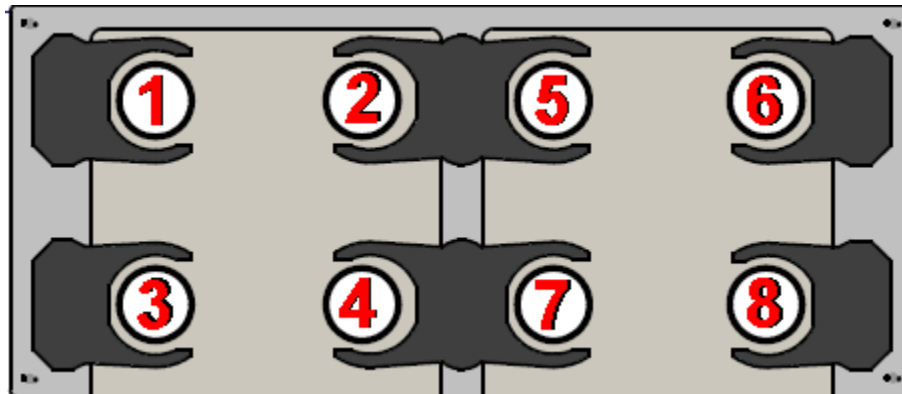

2.3 Safety Precautions

1. Do not operate this machine before the **TRAK 2^{OP} Installation, Maintenance, Service and Parts List Manual, Operating & Care Manual** have been studied and understood.
2. Do not run this machine without knowing the function of every control key, button, knob, or handle. Ask your supervisor or a qualified instructor for help when needed.
3. Protect your eyes. Wear approved safety glasses (with side shields) at all times.
4. Don't get caught in moving parts. Before operating this machine remove all jewelry including watches and rings, neckties, and any loose-fitting clothing.
5. Keep your hair away from moving parts. Wear adequate safety headgear.
6. Protect your feet. Wear safety shoes with oil-resistant, anti-skid soles, and steel toes.
7. Take off gloves before you start the machine. Gloves are easily caught in moving parts.
8. Remove all tools from the machine before you start. Loose items can become dangerous flying projectiles.
9. Never operate a milling machine after consuming alcoholic beverages, or taking strong medication, or while using non-prescription drugs.
10. Protect your hands. Stop the machine spindle and ensure that the CNC control is in the stop mode:
 - Before changing tools
 - Before changing parts
 - Before you clear away the chips, oil or coolant. Always use a chip scraper or brush.
 - Do not use compressed air to clean the machine.
 - Before you make an adjustment to the part, fixture, coolant nozzle or take measurements.
 - Do not attempt to disable any safety interlock. Never reach around a safeguard.
11. Disconnect power to the machine before you change belts, pulley, and gears.
12. Keep work areas well lit. Ask for additional light if needed.
13. Do not lean on the machine while it is running.
14. Prevent slippage. Keep the work area dry and clean. Remove the chips, oil, coolant and obstacles of any kind from around the machine.
15. Avoid getting pinched in places where the table, saddle or spindle head create "pinch points" while in motion.
16. Securely clamp and properly locate the workpiece in the vise, on the table, or in a fixture. Use stop blocks to prevent objects from flying loose. Use proper holding clamping attachments and position them clear of the tool path.

17. Use correct cutting parameters (speed, feed, depth, and width of cut) in order to prevent tool breakage due to premature wear.
18. Use proper cutting tools for the job. Pay attention to the rotation of the spindle: As viewed from above, left hand tool for counterclockwise rotation of spindle, and right hand tool for clockwise rotation of spindle.
19. To prevent damage to the workpiece or the cutting tool, never start the machine (including the rotation of the spindle) if the tool is in contact with the part.
20. Check the direction (+ or -) of movement of the table when using the jog feature, clockwise rotation of the EHW moves the axis in the positive direction, counterclockwise in the negative direction.
21. Don't use dull or damaged cutting tools. They break easily and become airborne. Inspect the sharpness of the edges, and the integrity of cutting tools and their holders. Use proper length for the tool.
22. Inspect the retention knobs for damage or excessive wear before each use.
23. Large overhang on cutting tools when not required result in accidents and damaged parts.
24. Prevent fires. When machining certain materials (magnesium, etc.) the chips and dust are highly flammable. Obtain special instruction from your supervisor before machining these materials.
25. Prevent fires. Keep flammable materials and fluids away from the machine and hot, flying chips.

Warning

Retention knobs come in a wide variety of designs, however they often look similar and appear to be interchangeable, but they are not. Use only the knob that the TRAK 2^{OP} is designed to use. The use of the incorrect knob, or the incorrect usage of a knob, may result in injury or property damage. To ensure the correct knob is chosen, please refer to Section 3.4.4, Retention Knobs section of this manual

3.0 TRAK 2^{OP} Description

3.1 Machine Specifications

Please see the drawing on the next page for a layout of the TRAK 2^{OP} machine.

Overall Machine Dimensions

Width of machine	30.5"
Depth of machine	52"
Height of mill with head all the way up	101"
Minimum height to fit mill through doorway (Z cable carrier collapsed, resistor cover and resistors removed)	92"

Machine Specifications

Table Dimensions

Table size	18" x 15"
Number of tee slots and pitch	4 @ 63 mm
Tee slot width	0.630" or 16 mm
Table maximum load	500 lbs.
Ball Lock ® hold down force	2250 lbs @ 35 in/lbs of torque
Machine Weight	~2825 lbs
Machine Shipping Weight	~3175 lbs

Travel

X-axis	14"
Y-axis	18" (12" of machining travel)
Z-axis	17"
Maximum distance from spindle nose table surface	20.25"
Minimum distance from spindle nose table surface	2.75"
Maximum swing clearance from spindle center to column	14"
Maximum Rapid speed X, Y & Z-axis, inches per minute	600

Spindle

Tool holder type	BT30
Spindle nose diameter	2.2" or 56 mm
Maximum RPM	6000

Automatic Tool Carrier

Tool Capacity	8
Maximum tool diameter	2 or ~50 mm
Retention knob	See section 3.4.4
Longest Tool that can be use in ATC – length measured from bottom of drive dog flange on holder	6.75"

Air Requirements

Pressure	90 psi
----------	--------

Quality

CFM
SCFM

Air dried/filtered water
separator upstream of the
machine
2.5 @ 90 psi
18

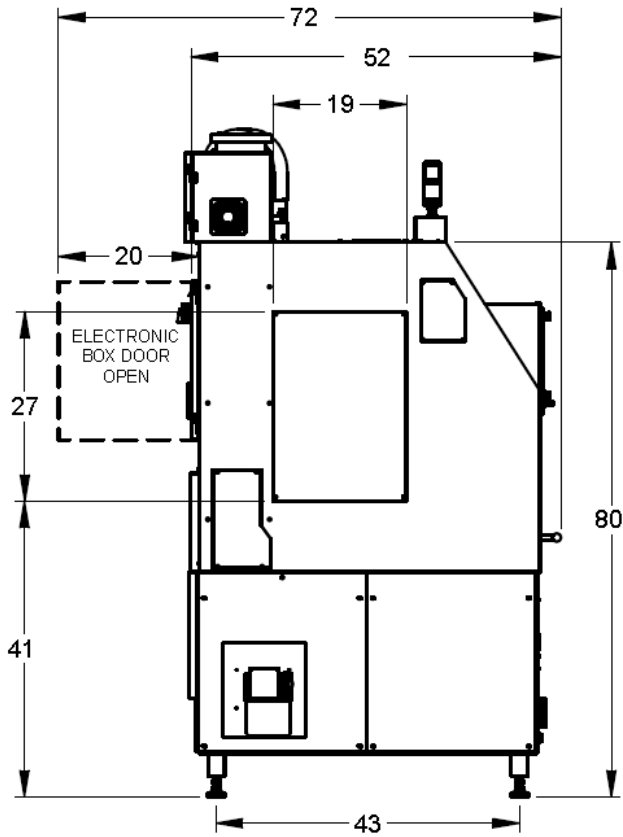

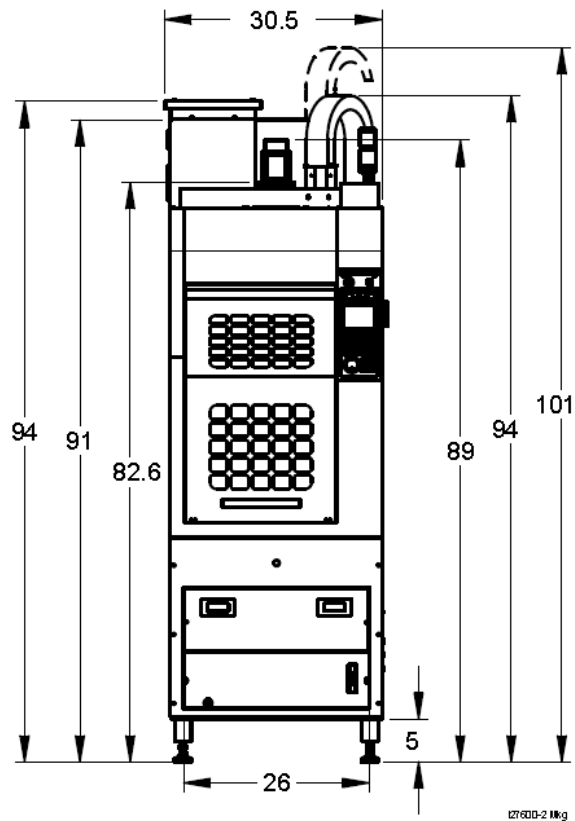

3.1.1 Shipping Kit

The following comes with the TRAK 2^{OP} as standard equipment:

- Pallet Jack
- Main Electrical Power Cord with Plug
- (4) Ball Lock Receivers in table

3.1.2 Floor Connection

The TRAK 2^{OP} machine has 4 adjustable leveling feet. It is important when moving the machine from one spot to another that all 4 feet are touching the floor. As floors vary, some adjustment may be necessary as you move the machine from one place to another.

For work that requires a high level of precision, you may have to level the machine using precision levels. In addition to this, the user should check the tram of the spindle relative to the table and adjust one or more of the 4 corners to adjust the tram within 0.001" TIR.

3.2 Maximum Spindle Torque and Horsepower

The following graphs illustrate the continuous and peak torque vs RPM and horsepower vs RPM for the TRAK 2^{OP} machine at the spindle. Peak torque and horsepower values can only be attained for a short period of time before the spindle drive will fault out to protect the motor.

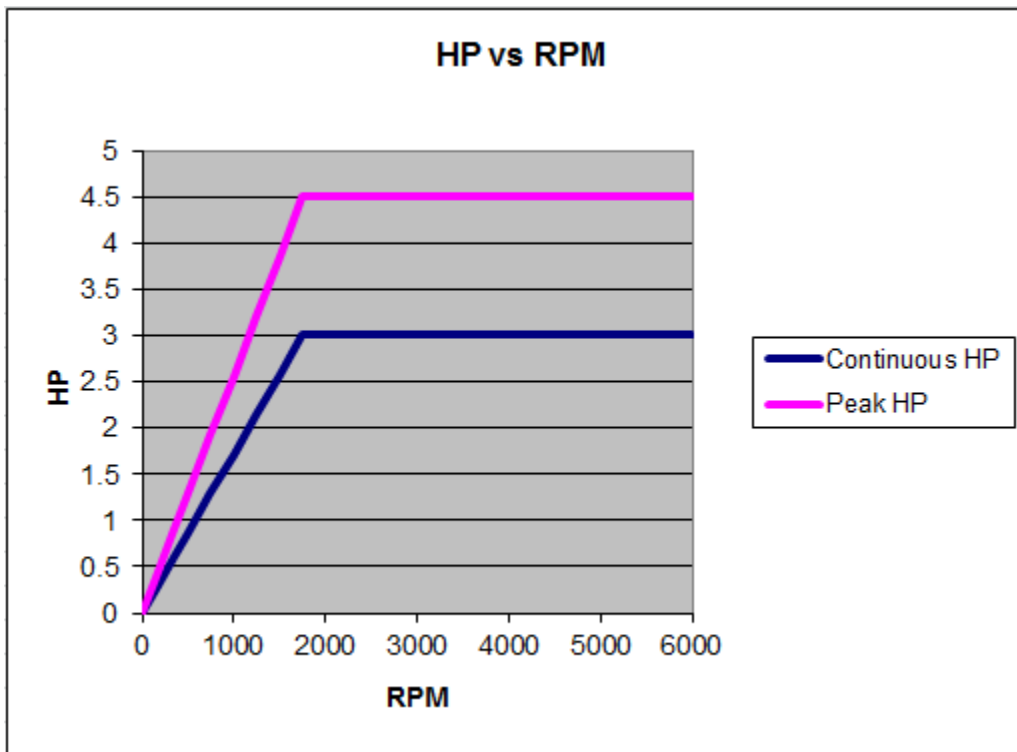
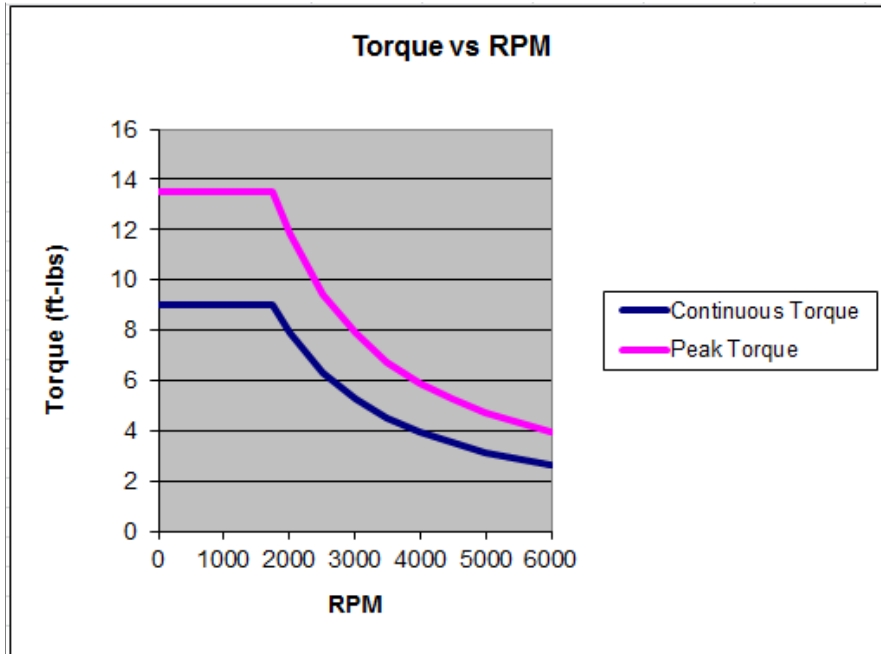

Note - Maximum work capacities are dependent on variables that cannot be controlled by the machine manufacturer. Each one of the following will have an impact on the above numbers: speeds, feeds, cutter, cutter sharpness, material, setup, coolant and machine adjustments.

3.3 ProtoTRAK TMX Control Hardware

3.3.1 Programming Panel Assembly

The programming panel assembly on the 2^{OP} is mounted to the front right side of the machine. The panel consists of the program overlay, electronic handwheel (EHW) and a 5.7" LCD.

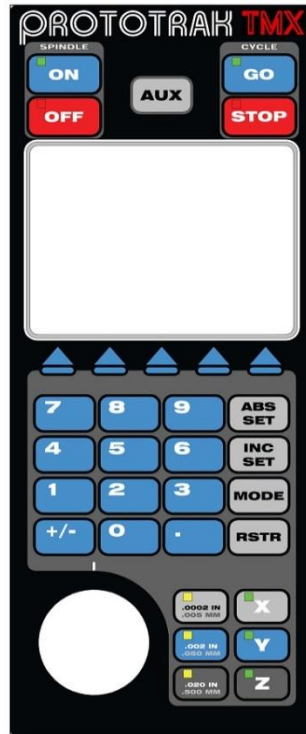

Keyboard Hard Keys

Cycle

GO: initiates motion in Run

STOP: halts motion during Run

Spindle

ON: turns spindle on in DRO mode

OFF: turns spindle off in DRO mode

AUX: enables / disables the auto coolant

Control

ABS SET: loads absolute dimensions and general data

INC SET: loads incremental dimensions and general data

MODE: to change from one mode of operation to another

RESTORE: clears an entry

0-9, +/-, . : inputs numeric data with floating point format. Data is automatically + unless +/- key is pressed. All input data is automatically rounded to the system's resolution.

X, Y, Z: selects axis for subsequent commands

.0002" / .005mm – electronic handwheel resolution

.002" / .050mm – electronic handwheel resolution

.020" / .500mm – electronic handwheel resolution

Arrow Keys

Beneath the LCD Screen is a row of arrow keys. These are called software programmable or soft keys. A description of the function or use of each of these keys will be shown on the LCD screen above it. If, at any time, there is no description above a key, that key will not operate.

Electronic Handwheel

The electronic handwheel serves 3 different purposes on the 2^{OP}.

The electronic handwheel will move the selected axis with the selected resolution in response to being manually turned. It is active in DRO, SETUP and selected service codes.

The electronic handwheel is used to override the spindle and feedrates. Each click of the electronic handwheel changes the speed or feed by 2%. You can go as high as 150% of what is programmed. Overrides can be changed in DRO and RUN modes and are modal. In other words, once you change them, they stay this way until you reboot the control.

Lastly, the electronic handwheel is used to scroll through program events and tables such as those found in the tool table. Each click of the electronic handwheel moves 1 prompt.

Emergency Stop Switch

The emergency stop (E-stop) switch kills all power to the ProtoTRAK's servomotors and the spindle motor. The computer and pendant remain powered.

The Liquid Crystal Display (LCD)

The display of the ProtoTRAK TMX is an active-matrix color LCD.

Servo On Button

The green servo on button found on the front of the programming panel turns power on to the axis motors. This button must be pressed at power up, after a fault condition and whenever the E stop button is pressed. The E stop must be in its normal out condition before pressing this button to turn on the servos. There is a prompt on the top of each screen that tells you if the servos are on or off. Upon boot up, you must press the servo on button and the prompt will change from SERVO OFF to SERVO ON.

3.3.2 The USB Port

There are 2 USB ports on the right side of the machine for an optional flash drive for program storage, transferring programs and for program backup. Software updates will be through the USB port. A keyboard/mouse can be plugged into one of these ports and will be needed if you are using the G Code Editor feature.

The port is USB 2.0 compliant.

3.3.3 Electrical Cabinet

The electrical cabinet is found at the rear of the machine. The electrical cabinet contains the main control hardware for the machine. It's main components are the computer module and AC spindle drive.

3.3.4 Computer Module

The computer module is the heart of the machine. All of the inputs and outputs are fed through this module. The computer module controls the programming panel assembly, AC spindle drive, servo drives, motor signals and feedback and input/output modules. Inside of the computer module is a motherboard, motion control board and an applications board along with a power supply.

The computer module also contains 2 USB ports. Both ports are extended to the programming panel for ease of access from the front of the machine.

3.3.5 Servo Motors

The TRAK 2^{OP} mill uses 3 servo motors with servo drives to run the X, Y and Z axes. The motors for the X and Y axis produce 21 in-lbs of continuous torque and 63 in-lbs of peak torque. The Z axis motor produces 28 in-lbs of continuous torque and 84 in-lbs of peak torque. The servo motors run off of 220 volt single phase power derived from the 220V, 3-phase input.

3.3.5 Servo Drives

The TRAK 2^{OP} mill uses 3 servo amps that are mounted in an enclosure that is mounted to the top of the machine. The servo amps are the same for both the X and Y axis. The Z axis uses a larger servo amp to drive the larger Z axis motor. A separate braking resistor is part of the Z axis servo amp circuit to dissipate heat generated when the motor is decelerating. The resistor is mounted to the top of this enclosure.

3.4 Machine Major Subassemblies

3.4.1 Spindle

The spindle is contained within a cartridge and BT30 tool holders must be used. The spindle bearings are permanently lubricated and require no additional attention by the user. The spindle has an air purge system that is automatically activated during the tool change sequence, it blows air down the spindle to prevent chips from being trapped between the holder and spindle taper. The spindle cartridge design is also pressurized by air to prevent contaminants from getting up inside the spindle.

3.4.2 Spindle Motor & Drive

The spindle motor is 3 HP and directly drives the spindle via a coupling. The RPM range for this machine is 50 to 6000 RPM.

3.4.3 Automatic Draw Bar Assembly

The automatic drawbar is an assembly consisting of an air cylinder and an actuator that unclamps the tool. Tooling is changed by means of the Automatic Tool Carrier (ATC), or can be done manually by pressing and holding the "Unclamp" button. Tools are clamped when the button is released. A clamping force of approximately 1000 lbs is generated to clamp the toolholder to the spindle. The Automatic Draw Bar Assembly uses system air and hydraulic oil and requires no adjustment. There is an oil reservoir for the hydraulics that should be monitored

on a regular basis. If there is a leak in the system the oil in this reservoir will go down. This leak will need to be fixed. The oil cup is found near the spindle clamping cylinder. See the service manual for more information.

3.4.4 Retention Knobs

The TRAK 2^{OP} Mill uses BT30 retention knobs as shown in Figure 3.4.4a. Tightening to the proper torque value is important for all retention knobs. Please see the retention knob manufacturer for the proper torque. You can order these retention knobs from Southwestern Industries under part number RETN KNOB-2OPM11. Our retention knobs should be torqued to 30 ft-lbs. It should be noted that lesser quality retention knobs will be torqued to something less than this.

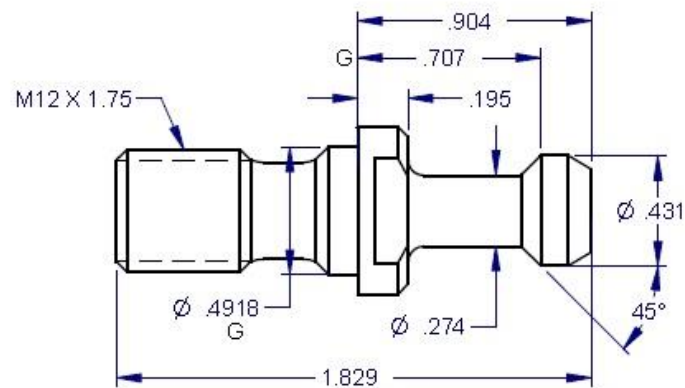

Figure 3.4.4a

Warning!

Retention knobs come in a wide variety of designs, however they often look similar and appear to be interchangeable, but they are not. Use only the knob that the TRAK 2^{OP} mill is designed to use. The use of the incorrect knob, or the incorrect use of a knob, may result in injury and/or damage to the mechanism.

3.4.5 Tool Changer (Carrier)

The tool changer is an 8 station mechanism that is actuated along the Y axis. It is hidden from view while the machine is cutting. The ATC mechanism slides forward on the Y axis linear guides and is actuated via an air cylinder.

3.4.6 Drive Train, Axes

Each axis (X, Y and Z) rides on precision linear guideways, with four preloaded recirculating ball carriages. Each axis is moved via a 6 mm pitch ballscrew. The axis motors drive the X and Y axis via a timing belt. The Z axis motor is directly driving the ballscrew.

3.4.7 Worktable

The TRAK 2^{OP} table utilizes Ball Lock® technology as well as conventional T-bolts. Each Ball Lock mechanism has a hold-down force of 2250 lbs when 35 in/lbs of torque is applied to the screw. The software on the TRAK 2^{OP} mill allows the user to save the X and Y location of your program relative to the lower left hand corner ball lock. There are 4 ball lock receivers mounted in the table and they are separated by 12".

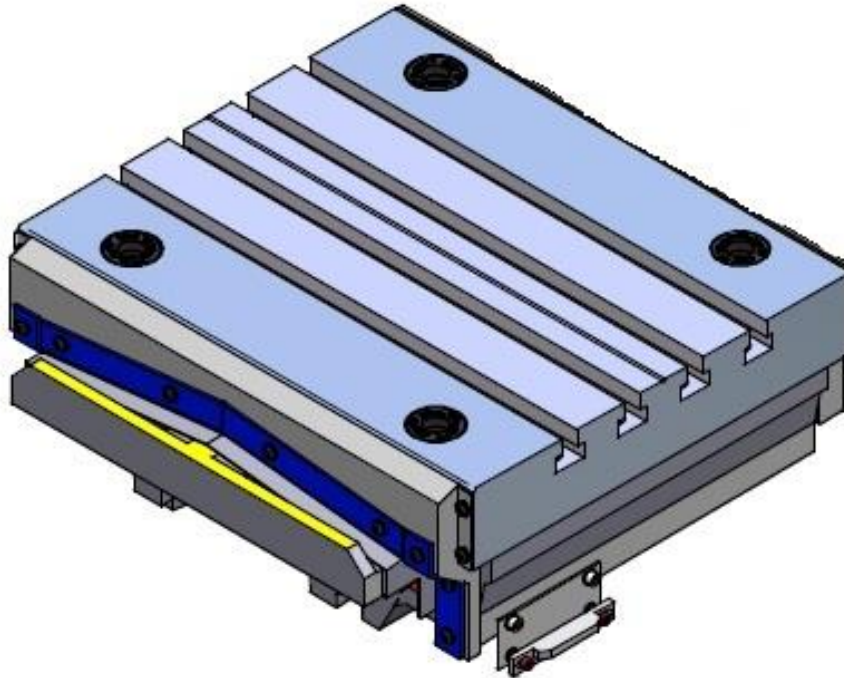

Figure 3.4.7a

3.4.8 Home Switches

Each axis has a home switch which is used to home the mill. The machine must be homed each time the control is powered on.

Warning

It is not recommended that the position of the home switches be changed. They are preset at the factory and should require no additional adjustments. Should any major adjustments be done, service codes 500, 505, and 520 may need to be performed.

3.4.9 Lubrication System

The automatic lubricating system is a centralized system. It is located on the left side of the machine. While the system is automatic, it is recommended that after long idle periods, the machine be manually lubricated by using service code 300. Cycle the lube pump two to three

times. The lubrication reservoir should be maintained on a daily basis, filling only with high quality lubricating oil. The control monitors if the lube pump oil level is low or the pressure is low during operation and will warn the user if either condition exists. See the service manual for more information.

CAUTION!
Always Observe Low Air Pressure and Low Oil Level Warnings

3.4.10 Coolant and Coolant Wash System

The coolant and coolant wash system uses one pump to provide coolant to the work and also to wash chips away from the area where the ATC comes out. Wash areas can be controlled by the flexible coolant lines found at the base of the enclosure.

The coolant tank holds approximately 15 gallons of coolant.

3.4.11 Pneumatic System

The machine requires a supply of compressed air between 85-100 psi with a recommended air supply of 1/2" I.D, minimum is 3/8" ID. Air pressure to pneumatic components, the ATC slide mechanism, and air purge (internal spindle) can be controlled individually by means of the adjusting valves located at the back of the TRAK 2^{OP} mill.

3.4.12 Enclosure Doors

The front door has an electro-mechanical safety interlock that must be engaged when running a CNC program. If the door is opened during a machining operation, the program will be shut down.

The enclosure is also equipped with left and right doors that are bolted in place.

CAUTION!
Do not Attempt to Disable or Override the Safety Interlock.

3.4.13 Status Light

The status light functions as follows:

- a. The green light is illuminated when the machine is running a program.
- b. The green light is flashing once per second when the operator input is required, such as when a part needs to be changed.
- c. The green light flashes 3 times per second when a fault condition exists.

3.4.14 Chip Removal

The chip pan is located in the front of the mill. To remove, lift up on the pan and pull forward.

3.4.15 Work Lamp

The TRAK 2^{OP} mill comes equipped with a fluorescent work lamp, which turns on automatically when the power is turned on.

3.4.16 Transformer

The TRAK 2^{OP} mill must be ordered for 200 to 240 or 400 to 480 volts. A transformer outputs 115 and 24 volts. During the installation of the machine, the wires to the transformer may need

to be moved to adjust the output voltage. From the factory the wires on the transformer will be placed on the 220 or 440 volt tap and 115 volt tap on the output side. It should be noted that the transformer is physically different for 220 volt machines versus 440 volt machines.

Warning

The input voltage to the machine should not exceed 240 or 480 volts. The spindle inverter is not rated for voltages higher than this. If the shop has voltages that exceed these numbers, they will need a step down transformer to lower the voltage. Voltages higher than this may void your warranty.

3.4.17 Pallet Jack

A pallet jack comes standard with each machine. It is used to move the machine around the shop as necessary. The pallet jack is rated for 5500 lbs. Please see section 4.3 for the proper methods to move the machine.

3.4.18 Power Cord

The TRAK 2^{OP} mill comes with a 220 or 440 volt power cord/plug so the machine can be easily moved around the shop. We also have a single phase option and machine will then come with a single phase plug. The female connector that needs to be provided by the end user should match the connector that is provided. Attached is a picture of the plugs. From left to right they are as follows: 220 volt 3 phase 30 amp plug, 440 volt 3 phase 20 amp plug and single phase 220 volt 30 amp plug.



Figure 3.4.18

The user must provide a power circuit that provides single or 3 phase 220 voltage 20 amp capacity (208 – 240 V acceptable) or 3 phase 440 voltage 10 amp capacity (400 to 440 V acceptable).

3.4.19 Way Covers

The X and Z axis come with accordion style way covers that protect the linear guides of the machine. The Y axis has steel way covers.

3.5 TRAK 2^{OP} Options

3.5.1 440 Volt Option

The TRAK 2^{OP} mill comes standard for 220 volts. If you require a 440 volt input, then a 440 volt option can be ordered. This option consists of replacing the AC spindle drive with a 440 volt unit and replacing the transformer with a larger unit along with a few other smaller changes.

3.5.2 Single Phase incoming power

The TRAK 2^{OP} mill has an optional single phase option for 220 volts. It needs to be noted that running the machine on single phase power reduces the spindle power by about 40% as compared to 3 phase 220 volt power. In other words, the spindle will not produce 3 HP. A different style electric cord plug is used with single phase power. As part of the single phase kit, we will provide an adaptor cable that allows the user to plug the machine into a 3 phase 220 volt power connector. Please note that the machine will still only run on single phase power with this adaptor. In order to convert the machine back to 3 phase power, a number of changes need to be done to the machine.

3.5.3 Liner, Primary

Primary liners are used to make all Southwestern Industries' manufactured fixture plates for the Jergens Ball Lock™ system. Primary Liners have an ID bore that is closer in diameter to the OD of the ball lock clamping shank. This in terms insures a tight fit and better repeatability when taking a ball lock fixture on and off the machine.

3.5.4 Liner, Secondary

Secondary liners are provided for those jobs that do not require the highest precision, for example jobs where the tolerance is a couple of thousandths. The ID of the bore on these liners is slightly larger than that found on a primary liner.

3.5.5 Fix-Plate-2OP M11

Precision plate (18" x 15") for use with the Jergens Ball Lock system. Comes with primary liners. Made of aluminum tooling plate that resists warping, either Alpase K100 or Alcoa Mic6.

3.5.6 USB Memory

A Flash Drive of 512MB minimum capacity

3.5.7 Fix-Vise-2OP M11

Fixture Plate Set Up for Kurt 3600V Vise. Includes plate, fence, vise stop and hardware. Does not include vise.

3.5.8 Ball Lock Clamping Devices

Clamping devices slide through the fixture plate liners and secure the plate to the table. The TRAK 2^{OP} clamping devices are options. If you order either of our fixture plates, you will also need to order the clamping devices.

3.5.9 Retention Knobs

The TRAK 2^{OP} uses BT30 retention knobs as shown in Figure 3.4.4a. This option includes 8 knobs.

3.5.10 Vise Stop

A convenient way to locate parts or fixtures on the fixture plate. Includes mag base and 1", 2" and 3" extensions.

3.5.11 TMX Offline Programming (PT80L)

This option is no charge, simply download the software from the Southwestern Industries' website and install it on your PC (sorry, no Mac versions available yet). It allows you to program your ProtoTRAK TMX CNC using the same screens as on the control itself.

3.5.12 ProtoTRAK Offline Programming (PT40L)

A great option for programming your ProtoTRAK TMX CNC. The PT40L gives you the powerful canned cycle programming of the ProtoTRAK SMX CNC on your desktop. Programming even complicated profiles is easy with features such as canned cycles for irregular pockets. The advanced Auto Geometry Engine and solid modeling interfaces bring an amazing amount of capability to the easy, natural programming of the ProtoTRAK.

3.5.13 Tool-BT30

A package of tool holders to fit the 30-taper spindle of the TRAK 2^{OP}.

Includes:

2 each end mill holder 1/2"

2 each end mill holder 3/8"

3 each ER-16 collet holder

1 each shell mill holder

3.5.14 Vise

A 3600V 6" vise from Kurt is available. It can be purchased from Kurt, but you must buy model 3600V-INT that comes with an internal hex for the vise handle. The 3600V model we sell comes with the vise handle shaft shortened as shown below.

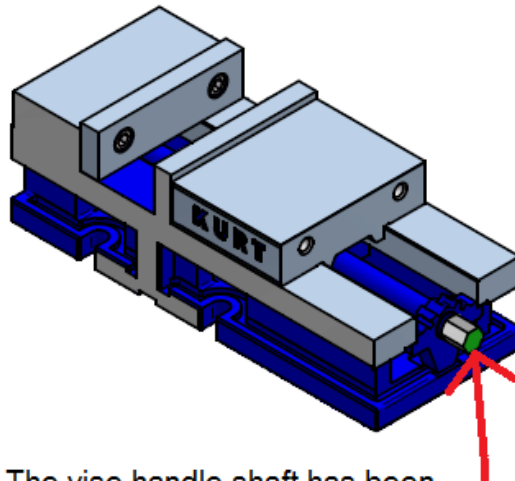

The vise handle shaft has been shortened on the 3600V vise we sell.

Warning!

WARNING

You must use the vise we sell or the model mentioned above to ensure there won't be any problems. If you choose to use a vise supplied from a different manufacturer, then you need to make sure that vise fits on the table and does not extend off the front or rear of the table. Many 6" vises are too large to fit within the work envelop of the machine. Specifically, the vise handle shaft often times protrudes too far and will hit the door when the machine performs a tool change. The damage from this could be substantial.

3.5.15 Tool Cart

A cart to hold your 30 taper tools. The cart is on wheels and can be moved around your shop with your machine. There is also a few trays on the cart to hold your miscellaneous tools.

3.5.16 Indexer Ready Kit

The TRAK 2^{OP} mill was designed to interface to an indexer unit. The indexer itself and interface cable must be purchased from Hardinge. The part number to order the indexer under from Hardinge is 5CZ1XNHF000000 and the part number for the interface cable is PCI0003011IC. We offer an indexer ready kit which provides a ball lock fixture plate, a mounting arm to mount the indexer control box, ball lock clamps to bolt the fixture plate down and mounting hardware. The customer must buy this from us. Our indexer ready kit will contain instructions on how to install the indexer. The customer will need to read the indexer user manual for how to operate the indexer.

4.0 Basic Operations

This section provides a starting point for learning to work with the TRAK 2^{OP}. It deals with some basic operations as well as items that are not covered in the sections that describe the Modes of the ProtoTRAK TMX that come after.

4.1 Power On

Follow this sequence to power up the TRAK 2^{OP}

1. Rotate the power knob on the electrical cabinet to the On position. Both the machine and the ProtoTRAK TMX CNC will power up.
2. Make sure the E stop is not pressed and then press the green SERVO ON button on the front of the panel. When the servos are on you will see a prompt at the top of the screen read SERVO ON.
3. Press SET HOME to initiate the machine homing routine.
4. Wait until the homing routine is finished.
5. Press OPEN TEMP (optional, see below). If you SET HOME first, you will need to get back to the initial screen by pressing RSTR.

4.2 Power Off

Warning!
Improper shutdown can cause problems with the operation of the ProtoTRAK TMX CNC.

Follow this sequence when shutting down the TRAK 2^{OP}.

1. Save your Temp File (optional, see below)
2. Get to the Start Screen (Press Mode, then RSTR).
3. Press Shut Down
4. Wait until the message appears: "it is now safe to shut off your computer".
5. Rotate the power knob on the electrical cabinet to the off position.

4.3 Moving the 2^{OP} Mill Around the Shop

The TRAK 2^{OP} mill was designed so it can be easily moved around the shop with the pallet jack that comes with the machine. Please follow the instructions below when moving the machine.

Machine relocation must be done by employees who are qualified and properly trained.

When moving machine using the SWI recommended pallet jack, following conditions must be satisfied:

1. The floor must be structurally rated to support and transport this machine (total machine weight without any accessories is approximately 2825 lbs).
2. The floor must be relatively flat and with a maximum slope not to exceed ¼ inch /foot anywhere along the transportation path.
3. Any steps, gaps or cracks in the floor that the pallet jack must go over, must be less than ½ inch high, wide, or deep.
4. The minimum door opening for machine to go through is 32 x 94 inches.
5. For best results, clear a 4' wide path for transportation prior to actually moving the machine.

TO MOVE THE MACHINE, PLEASE FOLLOW THE STEPS BELOW:

1. To prepare machine for relocation, move the X-axis to the approximate center, move the Y-axis all the way toward the door (front) until the (soft) limit is reached, move the Z-axis down until (soft) limit switch is reached.
2. Power down, and disconnect the machine's electrical power cord, and any other accessory cables connected to the machine.
3. Disconnect the machine's compressed air supply hose, and any other accessory hoses or attachments connected to the machine.
4. Close front door and check to make sure that nothing else is attached to the machine,
5. Check to make sure that the floor is free of any objects which may obstruct the movement of the pallet jack wheels or the machine along its transportation path.
6. Make sure that the door openings along the transportation path are adequate for the machine to go through.
7. For Front or Rear pickup; roll the pallet jack under the machine (roughly centered), as far as possible. Make sure that the pallet jack rails will positively support the front and rear structural cross-members of the base casting. From the Right or left side pickup, roll the pallet jack all the way as far as possible, where indicated on the side of the machine, to properly balance the machine load.
8. Lift the machine about 1/2-3/4 inches off the floor. **Note: never push or pull machine using the door handle.** While pulling, pushing and steering, monitor the movement of the machine to make sure that it does not run into or catch on anything during transportation. Carefully move the machine to the new location.
9. Once at the new location, **slowly and carefully** lower the machine down to the floor, and stow away the pallet jack.
10. Connect the electrical power cord, compressed air hose, and any other accessories disconnected before the move.
11. Power up the machine and check machine's tram. If necessary, adjust the machine leveling feet to achieve the desired tram result. All four legs must touch the floor.

4.4 Modes

The functions of the ProtoTRAK TMX are divided into Modes. Modes are groups of activities that belong together. Organizing the ProtoTRAK TMX this way makes it easy to use because you don't have to memorize how to do things. Simply select the Mode and then choose from the options.

The Modes of the ProtoTRAK TMX are:

DRO: DRO features for doing a small amount of machining and setting up to run a program. Speed and feed overrides can be adjusted here.

PROG EDIT (PROGRAM and EDIT): Where programs are written and edited.

SETUP: Where the machine and tool changer are prepared to run the parts.

RUN: Where programs are run to make parts.

PROG IN/OUT: To store and retrieve part programs.

Full description of each mode is in the appropriate section of this manual.

4.5 Emergency Stop

Press the button to shut off power to the axis motors and to the spindle motor. Rotate the switch to release and press the SERVO ON button.



When the ProtoTRAK TMX powers up you will see the soft keys shown above.

4.6 ProtoTRAK TMX Start Screen

4.6.1 Getting to the Start Screen

You reach the Start Screen when you first power up the ProtoTRAK TMX or by pushing the RSTR key from the Select Mode screen.

4.6.2 Soft Keys in the Start Screen

Set Home - Press to have the machine move to its home location. Must be done after each time the machine is powered down.

Serv Codes – opens up the service codes. See section 4.10.

Open Temp –Press this key to load in the temp file. More description of the Temp File is below.

Shut Down – press to initiate the shutdown process.

4.6.3 The TEMP File

Programs are stored and retrieved by the ProtoTRAK TMX with a flash drive (or other device) that uses the ProtoTRAK TMX USB port. When a program is saved in this way, it will not be saved with offsets or tool table information.

If you want, you can save your current program to a temp (temporary) file. Unlike the regular program storage, the Temp File will save the part zero, shift offsets and tool table along with the program. This is handy if you want to resume running the same part after shutting down and restarting the ProtoTRAK TMX. Go to the Program In/Out Mode and press SAVE followed by SAVE TEMP to save your temp file.

The Temp File will stay in memory until you save another program via the SAVE TEMP button.

The temp file can then be opened upon power up by pressing the OPEN TEMP button on the initial screen. If you forget to open the temp file before homing the machine, press the RSTR button to get back to this screen.

4.7 Manual Operation

The TRAK 2^{OP} may be run manually with the door open. This is most useful in setting up jobs but you may also do manual machining operations. Use the Electronic Handwheel in the DRO Mode for manual operation.

4.8 Electronic Handwheel

The Electronic Handwheel has the following uses:

Manual Operation in the DRO Mode. To do this, first press a resolution hard key to the immediate right of the hand wheel, then select the X,Y or Z axis.

Note: the numbers and markings on the Handwheel do not equate to precise positioning. Fast turning of the handwheel can cause the control to lose pulses. Use the dimensions displayed on the DRO for positioning.

As a Cursor. Use the Electronic Handwheel to select from a list of programs, move around in tables and move around in a program.

Overrides. Use the Handwheel to set an override percentage for Spindle Speed and Feedrate.

4.9 Moving Tools In and Out of the Spindle

To manually load and unload tools in and out, use the green button in front of the spindle.

Never manually load tools directly into the ATC. Tools must be loaded and unloaded via the spindle.

4.10 Service Codes

Service codes are treated in detail in the TRAK 2^{OP} Safety, Installation, Maintenance, Service and Parts List Manual, SWI publication No. 28170. We recommend that you consult the documentation before initiating a Service Code.

The following is a list of operator related service codes that you may need to perform.

Code	Description	Comment
33	Software, Firmware and PLC versions	Displays current software versions and system settings.
141	Load configuration file from USB thumb drive	To load configuration files from a USB thumb drive to the TMX control. Codes 141 and 142 might be used if we need to replace your computer module
142	Save configuration file to USB thumb drive	To save the configuration files for reloading later. When a computer replacement is necessary, saving the settings to a thumb drive for reloading them later is highly desirable.
316	Update Software	Runs the routine that copies new software from a USB thumb drive device to the ProtoTRAK system. Use this routine to install new ProtoTRAK software.
66	Metric Boot Up Default	To have the ProtoTRAK open up in mm measurement.
67	English Boot Up Default	To have the ProtoTRAK open up in inch measurement.
503	Set Maximum Feedrate	Sets the rapid speed for the machine. Default is 600 ipm
300	Set Lube Pump	Allows user to manual run lube pump and adjust frequency and discharge times.
1	Save programs, configuration files and logs	This service code automatically saves the users program, error log, fault log and configuration files to a USB device so it is easy to email all important information to our service department.

5.0 Definitions, Terms & Concepts

5.1 ProtoTRAK TMX Axis Conventions

X-axis: positive X-axis motion is defined as the spindle moving to the right when facing the mill.

Y-axis: positive Y-axis motion is defined as the table moving toward you.

Z-axis: positive Z-axis motion is defined as the Spindle moving up.

5.2 Absolute & Incremental Reference

The ProtoTRAK TMX may be programmed and operated in either (or in a combination) of absolute or incremental dimensions. An absolute reference from which all absolute dimensions are measured (in DRO and program operation) can be set at any point on or even off the workpiece.

To help understand the difference between absolute and incremental position, consider the following example:

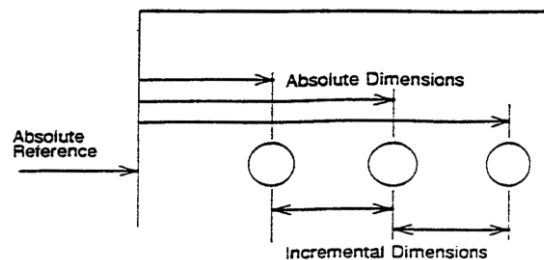

5.2.1 Some Rules for Incremental Reference Positions

In the section above, it was pretty clear what was meant by an incremental move. There are times that this is not completely clear. This occurs when you want to use incremental references for the first X and Y dimensioned data in a new event and the ending point of the previous event is not obvious. For example, with a circular pocket the ending point is not defined, what does the INC SET reference mean when programming the next event? Since this is not always completely clear, there are some sensible rules for what the ProtoTRAK TMX looks at in the previous event when the first dimensioned data is entered as an INC SET.*

** For events, such as Mill, that have an X,Y beginning and an X,Y end the second set of data is always referenced from the first.*

If the event is a:

- **DRILL**, then an incremental move is from the X, Y programmed in that previous event.
- **BOLT HOLE**, then an incremental move is from the X CENTER, Y CENTER programmed in that event.
- **MILL**, then an incremental move is from the X END, Y END programmed in that event.
- **ARC**, then an incremental move is from the X END, Y END programmed in that event.
- **CIRCLE POCKET** or **PROFILE**, then an incremental move is from the X CENTER, Y CENTER programmed in that event.
- **RECTANGLE POCKET** or **PROFILE**, then an incremental move is from the first or X1, Y1 corner programmed in that event.
- **REPEAT**, then an incremental move is the same as for the event types shown above, but shifted by the programmed OFFSET.
- **Z Rapid and Z Depth** are always incremental from the previous event.

5.3 Referenced and Non-Referenced Data

Data is always loaded into the ProtoTRAK TMX by using the INC SET or ABS SET key.

X, Y, Z positions are referenced data. In entering any X, Y, or Z position data, you must note whether it is an incremental or absolute dimension and enter it accordingly. All other information (non-referenced data), such as tool diameter, feedrate, etc. is not a position and may, therefore, be loaded with either the INC SET or ABS SET key. This manual uses the term SET when either INC SET or ABS SET may be used interchangeably.

5.4 Tool Diameter Compensation

Tool diameter compensation allows the machined edges shown directly on the workpiece to be programmed instead of the center of the tool. The ProtoTRAK TMX then automatically compensates for the programmed geometry so that the desired results are obtained.

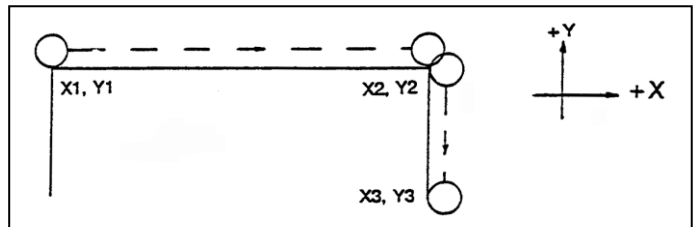

If the cutter in the sketch above is moving from left to right from point X1, Y1 to X2, Y2 and on to X3, Y3, these actual points can be programmed instead of the center of the cutter.

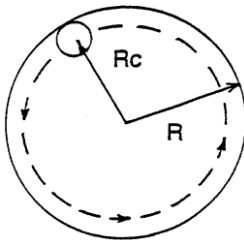

Or, the actual desired circle with radius R can be programmed instead of the radius of the center of the cutter Rc.

Tool cutter compensation is always specified as the tool either right or left of the workpiece while looking in the direction of the tool motion.

Examples of tool right are:

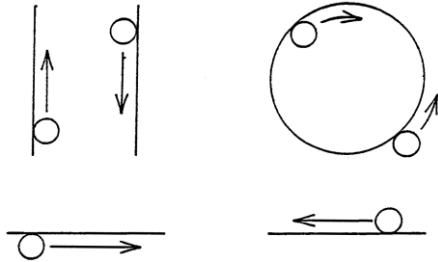

Examples of tool left are:

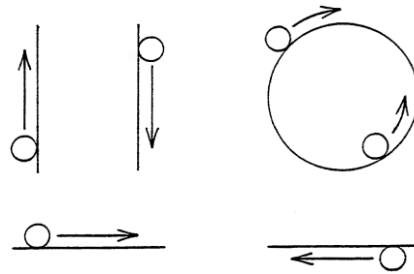

Tool center means no compensation either right or left. That is, the centerline of the tool will be moved to the programmed points.

5.5 Connective Events

Connective events occur between two milling events (either Mill or Arc) when the X, Y, and Z ending points of the first event are in the same location as the X, Y, and Z starting points of the next event. In addition, the tool offset and tool number of both events must be the same.

5.6 Conrad

Conrad allows you to program a tangentially connecting radius between connective events, or tangentially connecting radii for the corners of pockets and frames without the necessity of complex calculations.

For this figure, you simply program a Mill event from X1, Y1 to X2, Y2 with tool right offset, and another Mill event from X2, Y2 to X3, Y3 also with tool right offset. During the programming of the first Mill event, the system will prompt for Conrad at which time you input the numerical value of the tangentially connecting radius ($r=k$). The system will calculate the tangent points T1 and T2, and direct the tool cutter to move continuously from X1, Y1 through T1, $r=k$, T2 to X3, Y3.

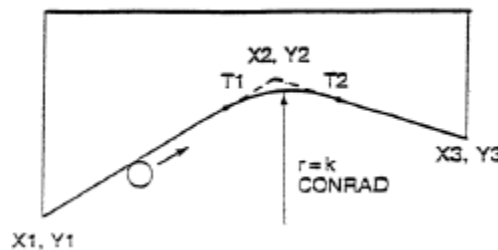

For this figure, you program an Arc event from X1, Y1 to X2, Y2 with tool offset left, and another Arc event from X2, Y2 to X3, Y3 also with tool offset left. During the programming of the first Arc event, the system will prompt for Conrad at which time you input the numerical value of the tangentially connecting radius $r=K3$. The system will calculate the tangent points T1 and T2 and direct the tool cutter to move continuously from X1, Y1 through T1, $r=K3$, T2 to X3, Y3.

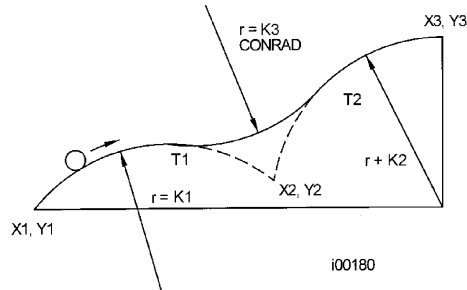

Note: Conrad must always be the same as or larger than the tool radius for inside corners. If Conrad is less than the tool radius, and an inside corner is machined, the ProtoTRAK TMX will ignore the Conrad.

5.7 Memory and Storage

Computers can hold information in two ways. Information can be in **current memory** or in **storage**. Current memory (also known as RAM) is where the ProtoTRAK TMX holds the operating system and any part program that is ready to run.

In contrast, storage is where the programs are saved until they are erased deliberately. Programs are stored on the ProtoTRAK TMX on an external USB drive (optional).

If power is lost or turned off, programs that are in current memory are lost, but programs stored on the USB drive are not.

Virus Protection / Third Party Software:

As a device, ProtoTRAK CNCs are not generally susceptible to viral infections. The part "programs" they run are non-executable text files. The ProtoTRAK TMX does not support any additional software installations, whether in the form of antivirus / malware protection software, or Microsoft updates. Software that runs in addition to our own may affect the performance of the motion control.

6.0 DRO Mode

6.1 Hard Keys in DRO Mode

The following Hard keys are used in the DRO Mode

Cycle

GO: initiates motion to position at selected Reference

STOP: halts motion

Spindle

ON: turns spindle on

OFF: turns spindle off

AUX: Toggles coolant on / off

Control

ABS SET: loads absolute dimensions and general data

INC SET: loads incremental dimensions and general data

MODE: to change from one mode of operation to another

RESTORE: clears an entry

0-9, +/-, . : inputs numeric data with floating point format. Data is automatically + unless +/- key is pressed. All input data is automatically rounded to the system's resolution.

X, Y, Z: selects axis for subsequent commands

.0002" / .005mm – electronic handwheel resolution

.002" / .050mm – electronic handwheel resolution

.020" / .500mm – electronic handwheel resolution

6.2 Soft Keys in DRO Mode

Return ABS 0 – initiates a routine to position X and Y at Absolute 0 and Z to the tool change height.

REF – gives you choices for which reference locations you want to work with

Overrides – allows you to override the spindle speed or feedrate, using the electronic handwheel.

Spin Speed – opens up the Spindle RPM box for you to type in the spindle speed

6.3 The ProtoTRAK TMX Screen in DRO Mode

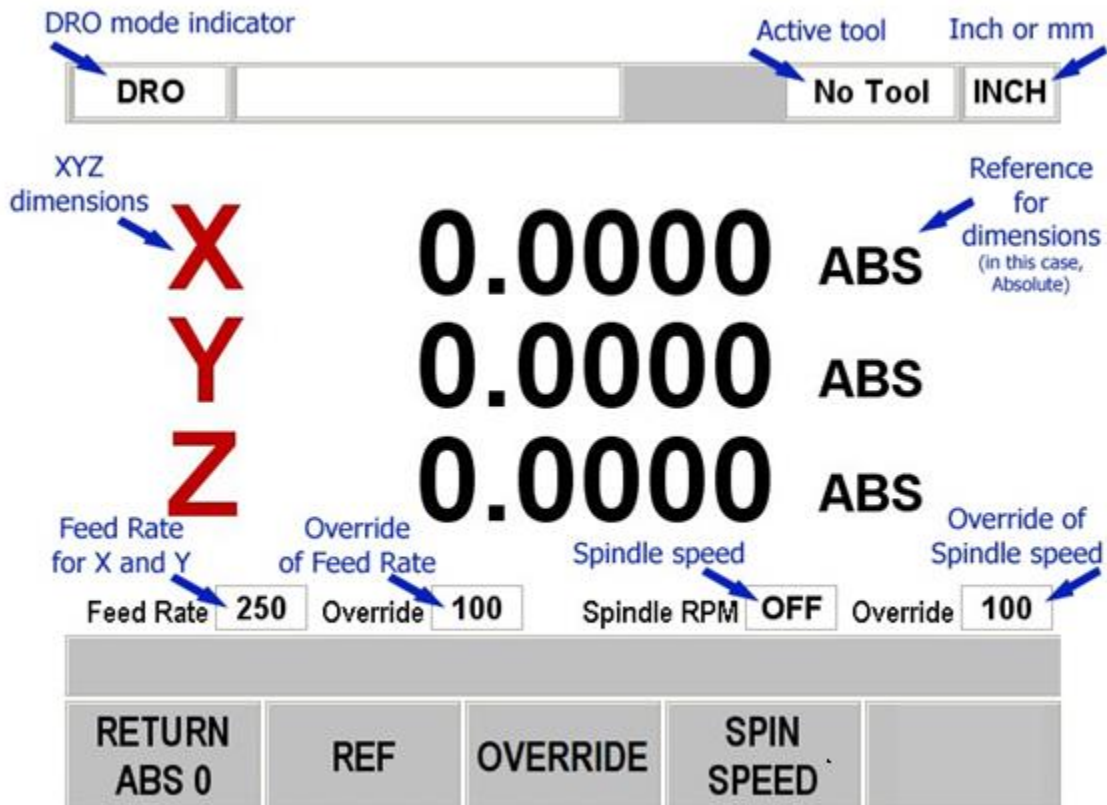

6.4 The Electronic Handwheel

In the DRO Mode, use the Electronic Handwheel for:

Manual Operation in the DRO Mode. To do this, first press a resolution hard key to the immediate right of the hand wheel, then select the X,Y or Z axis. The screen will show a symbol next to the active axis.

Note: the numbers and markings on the Handwheel do not equate to precise positioning. The control will smoothen out any abrupt or fast handwheel movement, resulting in some clicks of the handwheel to become ignored in favor of smoother motion. Use the dimensions displayed on the DRO for positioning.

Overrides. Press this button and then you can choose to override the spindle speed or feedrate.

6.5 Manual Operation in DRO Mode

Use the manual operation of the TRAK 2^{OP} for convenient setting of reference positions. You can also machine manually in the DRO Mode with the door open when you use the electronic handwheels.

6.5.1 Spindle Speed

Press the Spindle Speed soft key and enter the number. Press set. You will not see the spindle speed until you turn the Spindle On. You may override the spindle speed by pressing Override, Spindle override button and then turning the handwheel. Each click on the handwheel will create a 2% change.

6.5.2 Selecting Axis and Resolution

First select a resolution hard key to the immediate right of the hand wheel, then select the X, Y or Z axis.

Note: the numbers and markings on the Handwheel do not equate to precise positioning. Fast turning of the handwheel can cause the control to lose pulses. Use the dimensions displayed on the DRO for positioning.

6.5.3 Tools

You can load tools from the ATC or put tools into the spindle manually. To load tools from the ATC, you must go to SETUP mode LOAD TOOLS to load a tool in the spindle.

6.5.4 Coolant

The coolant can be turned on and off in DRO mode by pressing the AUX button. The spindle does not need to be running to turn the coolant on. Once you exit DRO mode, the coolant will turn off and if you re-enter DRO mode, you must press the AUX button again to turn it on. When turned on you will see a message saying 'AUX ON' above the feedrate prompt.

6.6 Moves to Reference Positions

The DRO mode has convenient moves to reference positions. Since these moves require the ProtoTRAK TMX to move the table, you must first close the door before pressing GO.

When moving to a reference position, the Z axis will first go to its home position (if it needs to move up first), then the table and spindle will move to the position in a direct line.

7.0 Program Mode

A convenient way to create part programs for simple operations is to program the ProtoTRAK TMX as part of the set-up of the job. The ProtoTRAK TMX CNC is ideal for shop floor programming because it is easy to understand, all essential information is prompted and the programming is accomplished by defining one or a series of **events**. It can either be a complete part, a set of operations on a side or only a small number of cuts.

7.1 Enter Program Mode, Assign a Program Name, Enter Ball Lock Locations and Turn Indexer Prompts On

To start programming, press MODE and select PROG EDIT soft key. For a new program to be written, there cannot already be a program in the active or current program memory. If there is a program in memory, see section 11.3 for how to erase it.

When you first enter Program Mode, you will encounter a screen that allows you to enter a program name or to enter the program at different events.

Event 0 is where you can enter the program name and save the X and Y ball lock offsets. Press MODE then PROG EDIT to get to Event 0.

The program name is highlighted and you may enter a new program name at this point. Program names are made up of 1 to eight numbers.

Note: It is not necessary to enter a program name. If none is entered and the INC SET or ABS SET button is pushed, the system will assume the program name is 0.

The ProtoTRAK TMX automatically holds all of the completed events as you program in current memory.

Enter Ball Lock Locations

The ball lock X and Y locations prompts are where the user might save the distance from the center of the lower left hand ball lock to the zero on your part. This allows the user to quickly reset the X and Y zero the next time you run your part using the same fixture. The user would move the machine to the center of this ball lock location and then manual position the X and Y axis away from this point by the numbers entered in these offsets. This obviously assumes your setup is repeatable.

PROG	P/N 001	SERVO ON	INCH
Program Name	001		
X Dimension from Ball Lock	0.0000		
Y Dimension from Ball Lock	0.0000		
Indexer Prompt	NO		
Program Name : 001			
GO TO BEGIN	GO TO END	GO TO #	

Indexer Prompt

The indexer prompt is where you tell the control you are using an indexer with the program you are running. The prompt is default to NO, but can be changed to YES once you highlight this prompt. Once it is changed to YES, each event will now have 2 new prompts that ask for AUX BEG and AUX END. The choice for each prompt is to enter "0" for no indexing required versus entering "3" for pulsing the indexer. In other words, when you enter 3, you are basically telling the control to stop the movement of the X, Y and Z axis either at the beginning or ending of an event and then telling the indexer to move. Once the indexer moves into position (the indexer is programmed on its own control box), the control will automatically continue running the program.

Choices at the beginning of Program Mode:

GO TO BEGIN: puts Event 0 on the left side of the screen and the first event on the right side.

GO TO END: puts the last programmed event on the left side of the screen and the next event to be programmed on the right side.

GO TO #: enter the event number you wish to go to and then press SET. This puts the requested event number on the right side of the screen and the previous event number on the left.

Note: for a new program that has no Events, all the GO TO selections will take you to the beginning, with Event 0 on the left and the Select an Event options for Event 1 on the right.

7.2 Programming Strategy and Procedures

The ProtoTRAK TMX makes programming easy by allowing you to program the actual part geometry as defined by the drawing. The basic strategy is to select the soft key event type (geometry) and then follow all instructions in the conversation line. When an event is selected, all the prompts will be shown on the right side of the information area. The first prompt will be highlighted and also shown in the conversation line. Input the dimension or data and press INC SET or ABS SET. For X, Y or Z dimension data it is very important to properly select INC SET or ABS SET. For all other data either SET will do.

As data is being entered it will show in the conversation line. If you make a mistake, for example, you press the wrong number key, you can clear the input by pressing RSTR (restore) button. When SET, the data will be transferred to the information area, and the next prompt will be shown in the conversation line.

Options within an event include:

INSERT EVENT: use this to insert a new event into the program. This new event will take the place of the one that was on the right side of the screen when you pressed the INSERT EVENT key. That previous event, and all the events that follow, increase their event number by one. For example, if you started with a program of four events, if you were to press the INSERT EVENT key while Event 3 was on the right side of the screen, the previous Event 3 would become Event 4 and the previous Event 4 would become Event 5. If you insert a Repeat event, the event numbers will increase by one as when you insert another kind of event.

DELETE EVENT: this will delete the event on the right side of the screen.

Look: this will draw the completed events programmed so far.

When all data for an event has been entered, the entire event will be shifted to the left side of the screen and the conversation line will ask you to select the next event.

Note – editing is done within an event by using the electronic handwheel. The electronic handwheel allows you to scroll within an event and between events.

PROG	P/N 99999998	INCH		
EVENT 0		EVENT 1	CIRC PCKT	
PROGRAM NAME	99999998	X CENTER	1.3180	abs
X BALL LOCK	0.0000	Y CENTER	1.3180	abs
Y BALL LOCK	0.0000	Z RAPID	0.0500	abs
		Z END	-0.2500	abs
		RADIUS	0.7500	
		DIRECTION	CCW	
		# PASSES	1	
		ENTRY MODE	PLUNGE	
		FIN CUT	0.0100	
		RPM	4000.00	
RADIUS : 0.7500				
LOOK		INSERT EVENT	DELETE EVENT	

7.3 Programming Events

7.3.1 Posn Drill

Posn : This will position the table and spindle to the location you define. It will move to this location at rapid feedrate.

Drill : This will allow you to feed the Z axis down into one XY location. The drill can be further defined as a regular drill, a bore, or a tap event. See section 7.4 for further details on each.

If a bore is selected, you can change the tool path of the bore from the default bore of feeding in and feeding out at the programmed RPM. After selecting Bore, scroll back over the BORE prompt. You will notice "?" soft key that is now visible. Press this button to change the tool path to feed down, position back toward the center of the hole and then rapid out of the hole. When you select this option, you will see 2 new prompts called Angle and Retract Dist. See section 7.4 for more details.

For the tap event, there is a Z Begin which tells the control where the top of the part is. We use this information, along with Z rapid, to figure out when exactly the Z axis needs to be up to the proper feedrate before entering the workpiece.

Selecting Help (blue question mark) at the first prompt of the Tap event will give you the ability to switch to a left-hand thread.

Note that 1500 RPM is the max allowable speed for the Tap event.

Bolt Hole: a series of holes spaced evenly around a circle. The drill moves can be further defined as drill, bore, or tap.

NOTE - On all RPM line prompts for all events except tap, a "?" will be visible as a soft key, which when pressed will allow the user to run the spindle in reverse. A "REV" prompt will show up in the event to the right of the RPM programmed.

7.3.2 Mill Event

Use this to machine a straight line in any direction. The prompts you answer in this event will allow the ProtoTRAK TMX to calculate the complete tool path, including the starting position and tool offsets. It is not necessary to program a rapid move to the beginning position of the Mill Event. (See the discussion on **Continue** below for the variation in tool motion if the event is connective).

7.3.3 Arc Event

This is any part of a circle. Like the Mill Event, the prompts you answer will allow the ProtoTRAK TMX to calculate the complete tool path. (See the discussion on **Continue** below for the variation in tool motion if the event is connective).

7.3.4 Pocket/Profile/Face Mill Event

Use this event to machine a pocket or profile with a minimal amount of programming. When you press the Pocket/Profile key, you choose between the following:

Circle pocket: a circle and all the material in the center. Includes a finish cut.

Rectangular pocket: a rectangle and all the material in the middle. Includes a finish cut.

Circle profile: a circular circumference. Includes a finish cut.

Rectangular profile: a square or rectangular circumference. Includes a finish cut.

Face Mill: this event defines a rectangle which is used to clean up the top surface of the part. Includes a Z finish cut.

When the program is run as a Profile Event, the ProtoTRAK TMX will rapid from wherever it is to 3 o'clock on circular pockets and profiles and X1, Y1 on rectangular pockets and profiles. Then it will move through the first pass and then the finish cut at the programmed feedrate and then move the cutter away from the part by the amount of the programmed finish cut.

The Pocket Event will rapid to the center of the circle or rectangle. Then move in a logical path through the material (leaving the finish cut, if one is programmed), using 70% of the cutter diameter. After the center is cleared, it will do the finish cut and ramp away from the part at the end by the amount of the programmed finish cut. The step over distance can be modified from 70% by pressing the ? soft key that is visible when you enter the first prompt within each of the pocket and profile events.

For the face mill event, the cutter will automatically start off of the part that you define. The cutter will move along the X axis to remove the material starting from where you defined X1, Y1 and finishing at the corner programmed as X3, Y3.

Note – if you press the HELP key when you are on the X1 prompt, you can adjust the step over distance of the face mill. The default is 95% of the cutter width. You can adjust it from 1 to 99%.

7.3.5 Subroutine Events

The Subroutine Events are used for manipulating previously programmed geometry within the XY plane.

The Subroutine Event is divided into two options: Repeat and Rotate.

Repeat and Rotate may be connective. As long as the rules of connectivity are satisfied, the ProtoTRAK TMX will continue milling between preceding and subsequent events.

REPEAT allows you to repeat an event or a group of events up to 99 times with an offset in X and/or Y and/or Z. This can be useful for drilling a series of evenly spaced holes, duplicating some machined shapes, or even repeating an entire program with an offset for a second fixture.

Repeat events may be "nested." That is, you can repeat a repeat event, of a repeat event, of some programmed event(s). One new tool number may be assigned for each Repeat Event. Repeat events may be "nested" up to five deep.

ROTATE is used for polar rotation of parts that have a rotational symmetry around some point in the XY plane. In addition to specifying the events to be repeated, you must also indicate the absolute X and Y position of the center of rotation, the angle of rotation (measured counterclockwise as positive; and clockwise as negative), and the number of times the specified events are to be rotated and repeated. You may not rotate another rotate event. Consider the figure below:

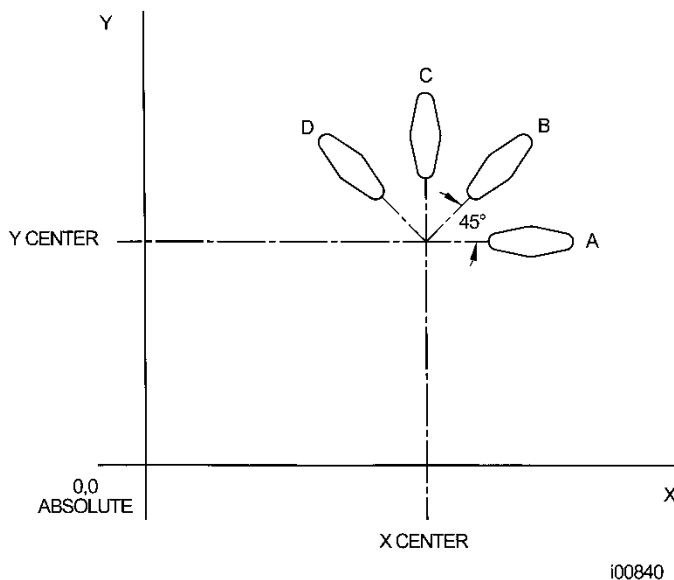

FIGURE 7.3 Shape A programmed with 4 MILL events and Conrads. Using ROTATE, these 4 events are rotated through a 45 degree angle about a point offset from absolute zero by X Center and Y Center dimensions. A is rotated 3 times to produce shape B, C, and D.

Press the **SUB** soft key to call up the Repeat and Rotate options.

7.4 Soft Keys and Prompts Used to Define the Events

Holes - the number of holes in the bolt hole pattern.

Drill – the tool will move from Z rapid to Z End at programmed feedrate for the number of pecks programmed and will move at rapid to Z rapid between each peck.

Bore – the tool will move from Z rapid to Z End at programmed feedrate, pause briefly at Z end, then move back to Z rapid at programmed feedrate.

Angle (within bore event)- is the angle from 3 o'clock CCW to the location of the cutting insert. Note – this requires the user to load the boring tool consistently into the spindle in the same manner. If you add the tool 180° opposite then the boring tool will crash when trying to move to the center of the hole.

Retract Dist - is the distance the cutting tool will retract towards the center of the bore

Tap – the tool will move into from Z Begin to Z End at the feedrate appropriate to tap the hole given the pitch and rpm. Rigid tapping is allowed, but for best results in most applications, we suggest that you use a floating tapping head.

Z Begin: the top of the work piece

Pitch - the distance from one thread to the next in inches or mm. It is equal to one divided by the number of threads per inch. For example, the pitch for a 1/4-20 screw is 1 divided by 20 which equals .050"

Angle - the location of the first hole to be machined in a Bolt Hole event. It is the angle from the positive X axis (that is, 3 o'clock) to the hole. The positive angle is measured counterclockwise from 0.000 to 359.999 degrees.

Conrad - There are two meanings to Conrad:

1. The connecting radius between line or arc being programmed and the next line or arc event. Simply enter the radius value at this prompt and the ProtoTRAK TMX will figure the tool path to go from one event to the next with a connecting radius. If no radius is desired, or if you are programming the last event, enter 0 by pressing the INC SET or ABS SET key without a number value.
2. The corner radius in a rectangular pocket or PROFILE. The radius is tangential.

Continue - to tell the ProtoTRAK TMX if the event is continuous to the next event(s) to be programmed. This saves inputs needed to define a profile. If the event is programmed with a Yes, for continue, then X begin, Y begin, Tool Offset, Feedrate and Tool # will not be prompted in the next one.

Direction - for an arc or circle, the direction is clockwise or counterclockwise.

Entry mode: choose between a zigzag ramp and a plunge when doing pockets. The plunge will machine straight down Z to the appropriate Z depth. The zigzag ramp will move in a zigzag pattern to depth. The tool will zigzag back and forth along the X or Y over a length of one tool radius while at the same time moving in the Z direction. When it travels one tool radius along this direction, it will have traveled a distance of ten percent of the tool diameter along the Z. This works out to roughly ramping into the part at an angle of 11 degrees.

Feedrate - the milling feedrate in in/min from .1 to 99.9 or in mm/min from 5 to 2500.

Fin cut - for a pocket or profile, the width of the finish cut. If 0 is input, there will be no finish cut. On some events you will see a "?" show up as a soft key on this prompt. If you press this button, you can add a Z finish cut to the event.

Radius - the radius of the bolt hole pattern, arc or circle.

Tool # - the number you assign to identify the tool.

Tool Diameter - the diameter of the tool. See the note on finish cuts later in this section.

Tool offset - the selection of the tool offset, right, left or center relative to the programmed edge and tool movement.

X or Y - the X or Y dimension, may be defined in absolute or incremental reference.

X Begin or Y Begin - the X or Y beginning point of the line or arc.

X Center or Y Center - the X or Y dimension of the center of the bolt hole pattern, arc or circle.

X End or Y End - the X or Y ending point of the line or arc.

X1, Y1, and X3, Y3 - the X and Y dimensions for the opposite corners on a rectangular pocket or profile.

Prompts unique to the Repeat event:

First Event # - the first event to be repeated.

Last Event # - the last event to be repeated. If only one event is to be repeated, the First and Last events will be the same number.

X Offset - the incremental X offset from the event to be repeated.

Y Offset - the incremental Y offset from the event to be repeated.

Z Offset – this is the Z offset you wish to apply from your previous Z end or Z depth. If you program 0 INC, the control will cut at the same depth as the previous event.

Repeats - the number of times the events are to be repeated up to 99.

Z Rapid – this is defined as the location from which the machine transitions from rapid feedrate to the programmed feedrate in your event. Typically this value is set 0.1" or 2.5 mm above the work piece.

Z End and Z Depth – this is defined as the depth you wish the Z axis to feed down to. For example, if you wish to drill a 1" deep hole, you would enter -1.0000" ABS.

of Pecks – this is how many times the Z will move up and down when drilling a hole.

? – options for programming this prompt.

Variable – drill peck where the drill goes to successively smaller depths and comes out of the hole between each peck. This is the default setting.

Fixed – drill peck where the drill goes to the same incremental depth per peck and comes out of the hole between each peck.

Chip Break – drill peck where the drill goes to the same incremental depth per peck, and pauses briefly at each depth.

Z Feedrate – this is the feedrate at which the Z axis will move from rapid to Z end.

Z Rapid Offset – this is the Z rapid offset you want to apply to your repeat event. If you program 0 INC, the Z rapid will be the same as your previous event.

7.5 Assumed Tool Offset, Feedrate, and Tool

When the INC SET key is pressed, the ProtoTRAK TMX will automatically program the following for these prompts:

TOOL OFFSET: for a Mill or Arc Event, same as the last event if that event was a Mill or Arc Event, otherwise, Tool Center.

FEEDRATE: same as last event if that event was a Mill, Arc, Pocket, or Profile.

TOOL #: same as last event, or Tool 1 in the first event.

You may change these assumed inputs by simply inputting the correct data when the event is programmed.

7.6 Incremental Reference Position

When X and Y data for the beginning position of any event are input as incremental data, this increment must be measured from some known point in the previous event. Following are the positions for each event type from which the incremental moves are made in the next event:

POSITION/DRILL: X, Y and Z programmed

BOLT HOLE: X CENTER, Y CENTER, Z RAPID and Z END programmed

MILL: X END , Y END, Z RAPID and Z END programmed

ARC: X END , Y END, Z RAPID and Z END programmed

CIRCLE POCKET or PROFILE: X END , Y END, Z RAPID and Z END programmed

RECTANGLE POCKET or PROFILE: X1 and Y1 corner programmed position

REPEAT: The appropriate reference position for the event prior to the first event that was repeated.

See Section 5.2.1 for additional information.

7.7 Finish Cuts

The Pocket and Profile events are designed with built-in finish cut routines because they are complete, stand-alone pieces of geometry. Shapes machined with a series of Mill or Arc events don't have an automatic routine for making finish cuts.

Instead, it is very easy to get a finish pass by overstating the size of the tool for the events in the initial pass, and then using a Repeat Event and programming a new tool with the actual size of the tool.

For the first pass, the cutter will be positioned away from the final cut half the amount of the difference between the actual size of the cutter and the diameter you put in. When the Repeat Events are run, the same cutter will be positioned correctly to do the final pass to size.

Note - This does require you to add two tools of the same diameter to the ATC.

7.8 SMX/PMX Program Events

The TMX control can run the more advanced events found on the ProtoTRAK SMX or PMX control. When a file is loaded from either of these controls, the events are shown in program mode and can be edited. If you do not have a SMX or PMX control, you can also create these programs by purchasing the PT4OL offline programming software. This software runs on your desktop computer. On the PMX control, you must save each program under the file extension .PT4 as opposed to .PT7, which is the normal PMX file extension.

It should be noted that you can only edit events created from our SMX or PMX control. In other words, once you load a program with these events, you cannot create new events of these types. An example of this would be our irregular pocket event. Having said that, if you bring over full 3D mill and arc events, where you can program the beginning and ending point for Z, the control will allow you to program future mill and arc events in the same fashion as opposed to only allowing a 2 ½ axis event. If you then erase this program with the full 3 axis mill and arc events, the next time you hit the mill or arc event it will be back to 2 ½ axis events.

When programs are loaded with the feature EVENT COMMENTS turned on, the control will allow the editing of event comments by pressing the ? soft key. This will bring up an alpha matrix box where you can use the electronic handwheel to scroll through the various letters. Pressing the ENTER softkey, when on the letter you want will add this to the screen and pressing END will close down the alpha matrix.

8.0 Changing or Correcting Programs

In the Program Edit Mode, you can easily correct mistakes or make changes to the program.

8.1 Deleting a Partially Programmed Event

If you wish to not program an event (or start over) after you have started to program, press the DELETE EVENT soft key and the screen will revert to the "Select Event" prompt.

8.2 Editing Data while Programming an Event

All data is entered by pressing the appropriate numeric keys and pressing INC SET or ABS SET. If you enter an incorrect number before you press INC SET or ABS SET you may clear the number by pressing RSTR. Then, input the correct number and press SET.

If incorrect data has been entered and SET, you may correct it as you are still programming that same event by using the handwheel to scroll through the previous prompts and events. Enter the correct number and SET. The ProtoTRAK TMX will not allow you to continue to a new event if you have skipped past prompts that need to be entered to complete an event.

8.3 Changing the Feedrate

If the feedrate is edited in any event it will automatically be edited in every subsequent and contiguous event with the same tool number and feedrate. For example, let's say events 5 through 10, and 13 through 16 were all programmed with tool number 2, and 5 inches per minute feedrate. If you edit the feedrate in Event 7 to 3 inches per minute, it will automatically change Events 8, 9, and 10 also. Events 5, 6, 13, 14, 15, and 16 will not be affected.

8.4 Changing a Part Number (Making a Copy of a Program)

You may want to rename a part program, or make a copy of a program using a different name. The latter may be useful if you have a new part to do that is similar to a part that you already have programmed. Make a copy of the program by saving it under a new part number and then make the changes.

You can rename a part program in two ways:

- Exit the Program Mode by pressing Mode and then re-enter it. You will have an opportunity to rename it then.
- Rename it in the Program In/Out Mode. After pressing the PROG IN/OUT key, simply enter the new part number and press SAVE.

If the previous part program is already stored on the system external storage (USB or Network) it will remain in storage under the previous part number with the same information it had the last time it was stored.

8.5 Saving Changes to a Program

If a program is opened from storage and changes are made, the program must be stored again in Prog In/Out Mode for the changes to be preserved in the stored copy. Programs in current memory may be changed and run with the changes, but unless they are saved again, the changes made will be lost when the program is cleared from current memory. If you intend to keep the changes made to your program it is a good practice to store the program occasionally in case a power loss causes the program to be ejected from current memory.

8.6 Erasing an Entire Program

To erase an entire program from *current memory*, go to the Program In/Out Mode and press ERASE CUR. You will be prompted "Are you sure you want to erase this program?" You may want to store the program before you clear it from current memory. If it is not stored, pressing YES will permanently erase the program.

To erase an entire program from the USB storage device, input the part number and then press DELETE. Programs in current memory will not be affected by this operation. You could erase a part number on the internal storage and the program in current memory will remain in current memory, even if it has the same part number as the one just erased.

Programs in current memory will automatically be erased when another program is retrieved from storage.

8.7 G-Code Editor

The G-Code Editor allows the editing of G-Code programs that are opened as .GCD files. The G-Code editor can only be accessed after you open a GCD program and then press the PROG/EDIT button. Once edited, the program may be re-saved as a .GCD file by going to PROG IN/OUT mode and pressing save. ProtoTRAK Geometry-style programs may not be saved as .GCD files.

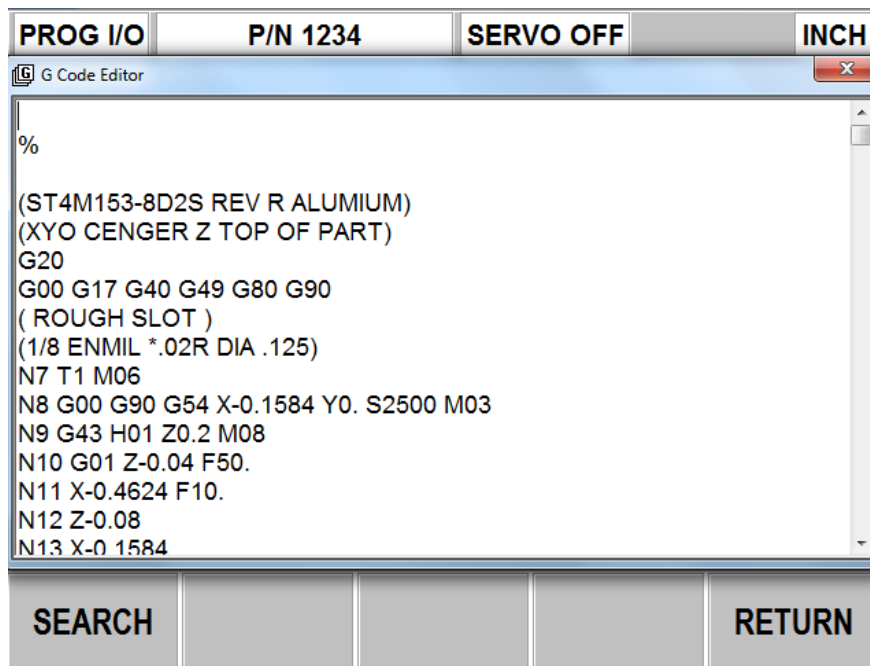

Figure 8.7.1 Use the G-Code Editor to modify G-Code programs.

You must connect a USB mouse and keyboard in order to use the G-Code Editor. Ideally you should use a USB keyboard that has a mouse built into it so this will take up 1 USB port and your USB thumb drive device will be loaded into the 2nd port.

When you enter the G-Code Editor, the G-Code program is displayed starting at the first Block Number. Use the scroll bar to move up and down through the program. Use the mouse and keyboard to edit like you would an MS Notepad™ file.

Search allows you to launch a simple find-and-replace routine to aid in editing large G-Code files.

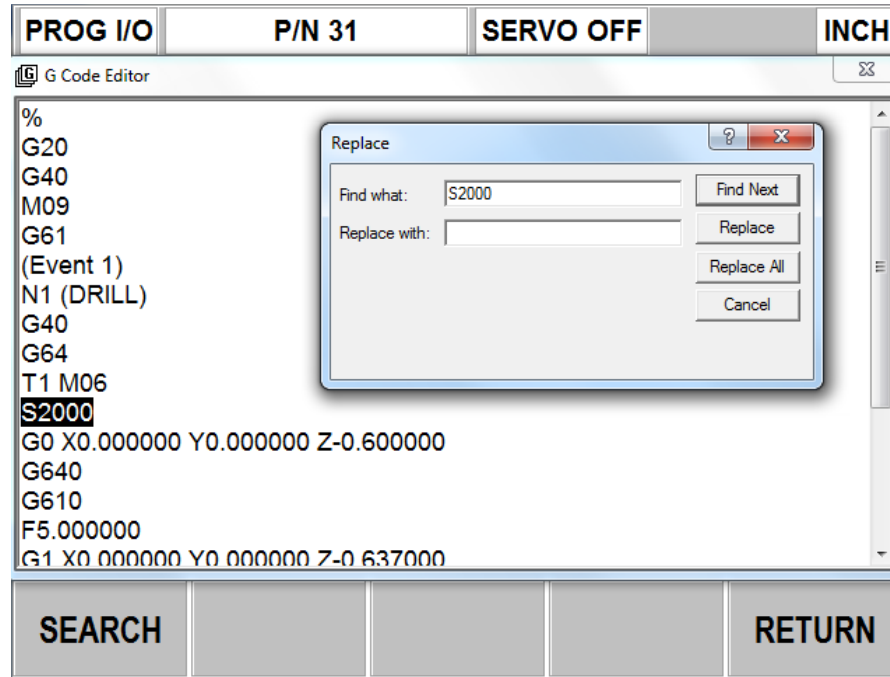

Figure 8.7.2 The find and replace routine.

Click in the Find What box and enter the item you want to find. Click on the Find Next box and the G-Code Editor will locate the next occurrence of that item. Successive clicks on Find Next will continue to search through the program. Use Match Whole Word to limit the search to the entire word. For example, if you want to find G2, but not G20 or G22, select Match Whole Word Only.

Instead of typing the item into the Find What box, you may simply highlight an item on the G-Code Editor screen. That item will be entered into the Find What box for you.

To make changes to Find What items, type what you want to have into the Replace With box. You can replace items one at a time by clicking first the Find Next box then the Replace With box for as many changes as you want to make. You can replace every item in the program with a single click of the Replace All box.

Return closes the G-Code Editor and returns to the Select Mode screen.

Note: You must leave the Thumb Drive plugged into the USB port the entire time the program is in current memory. If you unplug the thumb drive with the program still in current memory, the ProtoTRAK will display an error message.

9.0 Set-Up Mode

The Set-Up Mode is where you manage tools and fixtures and look at tool path. Most operations in the Set-Up Mode are guided by on-screen instructions. The following explanation of the soft keys provides additional information for using the Set-Up Mode.

9.1 Soft Keys in Set-Up Mode

Tool Table – opens the tool table. Any tool numbers called out in the program will be shown in red and the diameter entered. Use the Tool Table to add information about the tools.

Z Safety – sets a safety plane for the tool to move to prior to a tool change or when using MULTI PART feature. For MULTI PART, this is where the tip of the tool goes between parts. The value entered is measured from the Z absolute zero for the part. The default is +10". If the part zero is set high on the machine and hence your Z safety amount would exceed the Z travel, the machine will go to the Z home position assuming your program is not using the MULTI PART feature. For MULTI PART programs, you must set your Z SAFETY lower if it exceeds the travel limits of the machine. Viewing your TOOL PATH prior to run will identify if this is going to be an issue. You must enter a Z safety value each time a program is opened if you want the tools to go to a specific place prior to a tool change or when using the MULTI PART feature. The Z safety is not saved with your program.

MULTI PART – opens the shift offset table, used when you have one program that you want to run on multiple parts, requiring only an offset to be defined between them. The base (shift # 0) is the first part – the one you have defined and referenced. Use shift #'s 1 – 9 to define the location of additional identical parts. If there is nothing entered, the ProtoTRAK TMX will assume that there are no additional parts. If there is a value entered, the ProtoTRAK TMX will execute the same program in the location defined while in RUN mode.

When shifts are used, the ProtoTRAK TMX will conserve tool changes when it machines the parts. That is, it will machine consecutive events using the same tool on all the fixtures before changing tools.

Note that the Multi Part feature is available by default when a new program is being created or when opening a program that already contains shift offsets. It cannot be used in conjunction with Fixture Offsets or Work Coordinates.

FIXTURE OFFSETS – When importing a program that has fixtures defined from one of our other ProtoTRAK controls, this will open the fixture offset table and allow you to manage the offsets between them.

Fixture # 1 is the base fixture and is the ABS position that is referenced in the DRO screen. All other fixtures are referenced incrementally from the base fixture. All fixture #'s that are defined within the program are displayed in red.

Note that when fixtures are opened in a program, the Multi Part screen is no longer available to the user.

WORK COORD – When opening a GCD program that contains multiple work coordinates, such as G54, G55, etc, then this screen will allow the user to define the offsets between them. The offset values will not be imported through the gcode file, but rather the user must manually enter

them in this table. The work coordinates that are present in the gcode file will be displayed in red.

Note the Multi Part table is not available when multiple work coordinates are present, and the user only has the option to use one or the other.

Tool Path – will draw the X, Y and Z programmed motions.

Fit Table – draws tool path instantly. The white dotted lines represent the travel extents of the machine.

Fit – fits the drawing to the screen

Step – steps through the drawing one move at a time in any of the view adjustments selected previously

XY – draws with XY perspective

3D – draws with 3D perspective

Load Tools – add and remove tools from the Automatic Tool Carrier (ATC)

Return ATC – initiates the routine that returns the ATC to its storage location.

9.2 Working with Tools

The assumed use of this machine is for second operations and rapid deployment to respond to opportunities in the shop to take advantage of available labor. Thus, the TRAK 2^{OP} is organized to favor at all times first simplicity, then flexibility, then convenience (automation).

At times, these three items conflict. Such is the case with handling tools.

When it comes to tools, the TRAK 2^{OP} *assumes nothing*. After all, the machine must respond to a variety of jobs, tools and even operators. By keeping the operation of the ATC elemental, the TRAK 2^{OP} will force each operator to make sure the TRAK 2^{OP} will interact with the ATC properly.

While this may result in a little more time spent in setting up jobs, the reward is a higher level of certainty. Operators can get to the program run more quickly with the confidence that the tools are right for the job at hand.

9.3 Setting Tool Lengths

Each tool in your program must be touched off of a reference point to define the length of each tool. The Z axis offset prompt is where this touch off information is stored. The number that shows up in this prompt is the distance of the tool tip from the touch off point to the Z home position. This means the number should always be negative. We allow the user to type this number in if for some reason you write it down and want to re-enter it. The following is the procedure for touching off tools.

1. Load your first tool in the spindle.
2. Press the SETUP button.
3. Press Tool Table button.
4. Go to the corresponding Z axis offset prompt for the tool you loaded in the spindle.

5. Move your tool down to some reference point and press ABS SET. We recommend your reference point be some gage block or the top of the vise. We do not recommend you use the top of your part.
6. Exit tool table and go to tool loading to put the tool in the ATC. See below.

Z Modifier – this can be used to fine tune your tool depths. Positive values move the tool up and hence will make the tool cut more shallow.

Tool Type – allows you to define the type of tool you are using.

Manual Tools – all tools in your program labeled 9 or higher are considered manual tools. They are to be touched off in the same manner as all other tools. The difference is that these tools will not be added to the ATC. The user will put them in the spindle manually when prompted by the control in RUN mode.

Note
Please read section 11.1 for an explanation of how we handle tool table information when opening new programs.

9.4 Loading and Unloading Tools

The LOAD TOOLS button is used to move tools in and out of the ATC.

Warning
As stated in section 9.2, it is up to the user to make sure you don't make mistakes that can lead to crashes when using the ATC

The door must be closed when trying to move the ATC in or out. The following picture shows the screen you will see after moving the ATC out.

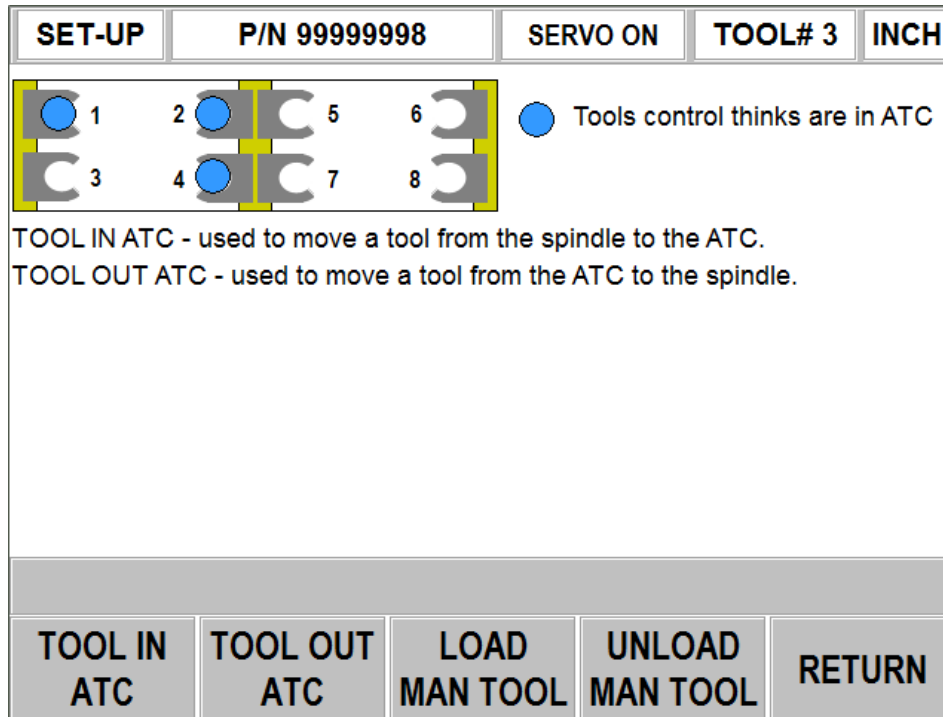

The following describes what is on this screen.

Tool in ATC button – Will insert the current tool from the spindle into the desired location in the ATC. In this example, if you press this button, it will prompt you to enter the spot you wish to put this tool into. In this case based on the figure above you should choose spot 1 since each tool in your program corresponds to the same spot in the ATC.

Tool out ATC button – Will remove the desired tool # from the ATC and load into the spindle. In this example, if you want to put tool 3 in the spindle, you must first put tool 1 back into the ATC using TOOL IN ATC. Once this is complete and the screen reads NO TOOL (in the box that reads TOOL #1) you should then press TOOL OUT ATC to initiate moving tool 3 into the spindle. Always look at the spindle to be certain it is empty before taking a tool out of the ATC.

LOAD MAN TOOL button – allows user to add a manual tool to the spindle. The control will now display the tool # in the status line. The spindle must be empty before you can add a manual tool. If it is not, then it will tell you to remove the tool from the spindle.

UNLOAD MAN TOOL button – allows the user to remove the manual tool and update the status line to say NO TOOL.

Tool # Box – this is the box directly to the left of the INCH or MM box in the upper right hand corner of the screen. It depicts what the control thinks is going on with regards to a tool in the spindle. It will read either NO TOOL (the control thinks the spindle is empty), a tool numbered from 1 through 8 or a tool number 9 or greater. Tools 9 or greater are considered manual tools and hence the user has to add and remove them. Manual tools would be used if your program requires more than 8 tools.

Blue Dots – the blue dots you see in ATC locations 2, 4, 5 and 6 indicate that the control thinks there are tools in those spots.

Important Notes about ATC Functionality

1. Remember that the ProtoTRAK TMX tries to keep track of whether or not there is a tool in the spindle or in a particular location in the ATC. However it has no way to know for certain. The safe operation of tool management requires that you visually check whether the spindle holds a tool or not and that you visually check if a particular ATC location holds a tool or not.
2. If you try to put a tool back into a spot in the ATC using TOOL IN ATC and the control thinks there already is a tool in it, we will warn you to make sure this is what you want to do. If you confirm to the control that this is what you want to do, the control will then move the tool down next to the tool change spot and then ask one more time if the spot is empty. After you confirm a 2nd time, we will put the tool away. If you answer NO, we will ask the user to press GO at which point we will move the tool back up to the tool change height.

Warning

If you answer YES to the last question and there is a tool in the spot you are trying to put a tool, the machine will crash and it is highly likely you will damage your ATC. Please be careful when loading tools in and out of the ATC.

3. If you try to move a tool from the ATC to the spindle using TOOL OUT ATC and the control thinks a tool is in the spindle, it will ask you if the spindle is empty. When you press GO, the machine will move over the top of the new tool you want to load and then ask if the spindle

is empty. If a tool is in the spindle and you still press YES followed by GO, the tool will drop from the spindle and then the spindle will lower to load the tool in that ATC location. If you press NO the tool will not drop and you will be returned to a prior screen.

4. If you place a tool in the spindle in DRO mode manually, the control will not know that this tool has been added. This can lead to a crash. You must make sure what is in the spindle is in fact the correct tool before running a program. When you start a new program, you must have the first tool in the program in the spindle prior to running it. If you do not, you will get an error message. If the control thinks the correct tool is in the spindle, but you put a different tool in the spindle, the control will run with the wrong tool.

10.0 Run Mode

The Run Mode is where you have the machine make your parts. Like the other Modes in the ProtoTRAK TMX, there are instructions on screen to guide you.

10.1 Run Mode Checklist

Before running, do the following:

- set up your tools in the ATC in the Set-Up Mode
- add additional tool information to the tool table in the Set-Up Mode
- set absolute 0 in the DRO Mode
- draw and verify your part's tool path in the Set-Up Mode
- check your Z Safety height in the Set-Up Mode if using fixture offsets
- load the first tool called out in the program into the spindle on Set-Up Mode
- in run mode press the AUX button to have the coolant come on and off when the spindle comes on and off. When pressed, the screen will say AUX ON.

10.2 TRAKing™

The TRAK 2^{OP} supports the quick set up and running of jobs. One of the ways it does this is TRAKing.

When you start running your program, a soft key will appear that says TRAKing. When you press this soft key, the ProtoTRAK TMX will put the control of the X, Y and Z feed into your hands. As you rotate the Electronic Handwheel, the ProtoTRAK TMX will run through the program. You may select different resolutions to determine how much the machine moves in relation to your turns by pressing one of the keys immediately to the right of the Handwheel. The button labeled 0.020"/0.500 mm button will allow TRAKing to run the fastest when you turn the electronic handwheel. Pressing the 0.002"/0.050 mm button will limit the speed of TRAKing and 0.0002"/0.005 mm button will limit the speed further yet.

With TRAKing, you are in complete control of the run of the program. You can run the entire program this way, or you can run only as much as necessary to assure yourself that everything is okay.

At any time, you may start running automatically. Press the Stop hard key, then CNC RUN, then Go. The TRAKing and CNC choice will appear whenever you press the Stop hard key, so you may toggle between them as you wish.

10.3 Soft Keys in Run Mode

START – starts running the program from the beginning.

START EVENT # – starts running the program from an event in the middle. If you press this key you will be prompted to enter the event number for where to start. You must make sure the correct tool is in the spindle for the event you are starting on.

TRAKing – puts the program run under your control using the Electronic Handwheel.

CNC Run – runs the program automatically

FEED OVRD – enables you to override the programmed feedrates from 0% (stopped) to 150% of the programmed feedrate.

SPIN OVRD - enables you to override the programmed spindle speeds from 0% (stopped) to 150% of the programmed spindle speed.

10.4 Overrides

During program Run, you may adjust the Feedrate and Spindle Speeds by applying overrides instead of going to the program and making changes. The electronic handwheel is used to modify the overrides. If you do override either the feedrate or spindle speed, those overrides will apply to all operations until you decide to change them again.

11.0 Programming In/Out Mode

When you go into the Program In/Out Mode you will see a list of programs that are stored on the device connected to one of the USB ports or programs that are stored on a different computer over the network. See section 11.5 for more information on networking the ProtoTRAK TMX.

NOTE - your programs must be contained in a folder called "2OP PROGRAMS". The name of the folder is not case sensitive. The first time you save a program to a USB device the ProtoTRAK TMX will create this folder for you.

If the number of programs on your USB device exceeds what can be shown on the screen, then you can use the Electronic Handwheel to scroll the pages so you can see all of your programs. You must type in the part number and press OPEN to open this file.

The ProtoTRAK TMX can only have one program at a time in current memory.

Programs may be stored for future use on a flash drive connected to the USB port by pressing the SAVE button.

Part programs are saved to storage or opened from storage in the Program In/Out Mode. When programs are transferred back and forth from current memory and storage, they stay in both locations unless erased or cleared. In other words, opening a program from external storage (USB or Network) into the current memory does not remove it from the external storage. Only deleting the program will remove it.

11.1 Cautions about Opening and Deleting Programs and Tool Table Functionality When Opening Programs

Care must be taken to keep from losing a program you wish to keep. This can happen two ways.

First, whenever a program is opened, it is loaded into the ProtoTRAK TMX's computer program memory. When this happens, your existing current program is erased. Therefore, if your current program is one you want to keep, be certain to store it before you retrieve another program.

Second, to store a program it must have a part number (numeric only) so that the ProtoTRAK TMX can find it when you want to open it. However, no two programs can have the same part number. Therefore, if you store a program with any particular part number, it will automatically erase any other program with that same part number.

In both cases above the ProtoTRAK TMX will give you a warning before erasing or overwriting your program.

You must also be aware that once you open a new program, the tool table information will be lost, including all your tool length offsets if the tool diameter and tool name on the control do not match exactly the tool diameter and tool name for the program you are opening. We warn the user prior to erasing the tool table with the following message.

WARNING3011: TOOL OFFSET CLEARED

There are tools in the part program that do not match the tool table.

The Z offsets for those tools will be cleared, press RESUME.

It should be noted that when you open any GCD program we will ask the user if they want to keep the existing offsets in the tool table, they include the tool diameter, Z offsets, Z modifier and tool name in the table. Remember that GCD programs do not have tool information inside of the file so we have no means to compare the existing tool table in the control to what the GCD program will require.

Please note that our original release of software did not have this tool table functionality and hence all tool Z offsets were erased each time you opened a program.

11.2 Program Formats and Labeling

The ProtoTRAK TMX will run two types of files, those with extensions .PT4 and .GCD.

11.2.1 .PT4 Files

.PT4 – this file extension belongs to a ProtoTRAK program written using one of the following Southwestern Industries’s products:

- PT4OL – ProtoTRAK Offline software
- ProtoTRAK VM or SM CNC
- ProtoTRAK SMX CNC
- ProtoTRAK TMX CNC

Programs written as 2-axis operations will not be recognized by the ProtoTRAK TMX and will not open. You can open programs written on the PMX control, but you need to save those files under the .PT4 file extension.

The above products all have features not found on the ProtoTRAK TMX. However, programs that use these features may be run on the TRAK 2^{OP}. PT4 programs may be viewed and edited on the ProtoTRAK TMX CNC, but you cannot create new events not supported by the ProtoTRAK TMX.

Note: while the above may seem a bit limiting, please keep in mind that the TRAK 2^{OP} is optimized for second operations and as such, *must be kept easy to use*. Second operations on most parts are so simple that they can be programmed right at the machine using the simple events available.

11.2.2 .GCD files

A .GCD file is a file made on a CAM system or RS274 standard CNC.

Below is a list of supported G and M Codes.

G-Codes Recognized by the ProtoTRAK TMX GCD Converter

G Code	Description	Sample Code	Notes
G00	Position at maximum feedrate	G00 X0.0 Y0.0 Z0.0	
G01	Linear Interpolation	G01 X0.0 Y0.0 Z-1. F15.	F = Feedrate in Inches per minute
G02	Circular Interpolation (Clockwise)	G02 X1. Y2. I0. J2. (see note below)	I, J, and K define the X,Y, and Z center points respectively.

G03	Circular Interpolation (Counter-clockwise)	G03 X2. Y0. I2. J0. (see note below)	Values are incremental from the starting point of the arc.
G04	Dwell	G04 P1000	P specifies # of milliseconds. P1000 = 1 second
G06	Helix (Clockwise)	G06 X0. Y0. Z0. I1. J0. K0. D2.0	D defines the # of revolutions.
G07	Helix (Counter-clockwise)	G07 X0. Y0. Z0. I1. J0. K0. D2.0	
G17	Select XY Plane	G17	G17 only apply to G2 and G3.
G20	Input in Inch	G20	Default
G21	Input in Metric	G21	
G40	Cutter compensation cancel	G40	
G41	Cutter compensation left	G41	
G42	Cutter compensation right	G42	
G54 thru G59	Select Work Coordinate #1	G54 thru G59	Opening 2 or more work coordinates will enable the WORK COORD option in SETUP mode.
G80	Canned cycle cancel	G80	
G81	Drilling cycle, spot boring	G81 X0. Y0. Z-1. R.1 F15.	Z = final depth, R = rapid position
G82	Drilling cycle, counter boring	G82 X0. Y0. Z-1. R.1 P500 F15.	P = dwell time in milliseconds
G83	Peck drilling cycle	G83 X0. Y0. Z-1. Q.125 R.1 F15.	Q = depth of peck
G84	Tapping cycle	S300. G84 X0. Y0. Z-2. R.1 B0. Q.05	S = RPM B = Begin depth Q = Pitch Feedrate is calculated by S x Q
G85	Boring cycle	G85 X0. Y0. Z-1 R.1 F15.	
G86	Boring canned cycle with retract	G86 X0. Y0. Z-2. R.1 B35. Q.020 P300 F15.	B = Angle of boring head. Q = Retract distance, away from B.
G89	Boring cycle, dwell at bottom	G89 X0. Y0. Z-1 R.1 P800 F15.	P = dwell time in milliseconds
G90	Absolute Mode	G90	Default
G91	Incremental Mode	G91	
G98	Use previous Z position as Rapid plane	G98	Default

Accepted M Codes

M00	program stop (press go to proceed)
M02	end of program (no rewind)
M03	spindle on CW or FWD
M04	spindle on CCW or REV
M05	spindle stop
M06	tool change
M21	pulse indexer
M30	end program (rewind stop)
M333	enable low pass filter*
M334	disable low pass filter (default)*

*The low pass filter is used for applications where higher block per second performance is desired, such as for surfacing programs. It will look ahead more blocks of g code, and blend moves together to achieve smoother motion. Note that when enabled, sharp corners may be rounded off at higher feedrates. When running event programs, our machine runs with this option disabled.

All other M codes will be ignored.

Notes:

1. Place M Codes on same line as movement G Code.
2. One M Code per block.
3. All values are in Absolute, except for I, J, and K values for arcs.
4. The AUX button is used to turn coolant on and off based on the spindle being on and off. When the spindle is on, the coolant is on.

G-Code and Post Processors

In order to run a G code program, the program must be posted through a post-processor that makes some adjustments to the output of the G code so that it is understood by the ProtoTRAK. The ProtoTRAK uses a post-processor that is very similar to the Fanuc 6M, but there are differences. You need to make sure you use a post-processor designed for our control. A generic post-processor will most likely not work.

If you are not familiar with writing a post-processor, we recommend that you contact your CAD/CAM supplier. We will be happy to work with them to get you the post-processor you need.

Writing a Post Processor

The following are modifications to a Fanuc 6 post-processor that are necessary for writing the ProtoTRAK post-processor.

Beginning file format: The ProtoTRAK has no special requirements, it does not need any special characters.

End of file format: the ProtoTRAK requires the % to show the end of the file. Characters after the % will be ignored.

Beginning of an operation: the ProtoTRAK requires that the tool number, feedrate and tool comp appear before, or on the same line, as a move command. The absolute zero of the ProtoTRAK is set in a different mode and does not need to be set at the beginning of each operation. The feedrate is modal, once it is set, it remains the same until changed.

Coordinates: may be formatted in inch or metric. The addresses used for specifying coordinates are X, Y, Z, I, J, K. The valid ranges are:

- Inch: min -999.9999 to max +999.9999
- Mm: min -9999.99 to max +9999.999

Integer values MUST be followed by decimal. Ok to truncate 02.0000 into 2.0

Linear moves: G01 are formatted the same as rapid moves.

Arcs: Arc centers are specified by the address I, J and K for the X, Y and Z axes. The number following the I, J and K are incrementally referenced from the starting point of the arc. Radius values are not allowed.

Tool Numbers and Tool Changes: the format of the tool number is from T1 to T99. The M06 command initiates a tool change.

Feed rates: the ProtoTRAK is programmed in inches (or mm) per minute using the 'F' address.

Spindle speed: S1000 means 1000 RPM

Turning the Spindle on: the spindle is turned on with M03 or M04 command.

File name: use the .GCD extension so the ProtoTRAK will recognize the file as a GCD file. File names must use numbers only and may include up to 8.

Notes

1. Tool offsets, diameters, modifiers, home positions and work offsets are defined on the ProtoTRAK control and are ignored through G code.
2. G2 and G3 are not used for helix. See G06 and G07.
3. You must specify an I, J and K for all arcs, even if you are doing an XY plane arc where the Z axis is not moving. In this case the K value must be defined. It will be modal from there on.
4. For lead in moves where you are using G41 or G42, G41 and G42 need to be placed before the Z axis moves down to position so the tool is compensated along X and/or Y correctly before performing a lead in move.

11.3 Soft Keys in Program In/Out Mode

PROG I/O	P/N 0	INCH		
12345.PT4				
Program Name : 0				
OPEN	SAVE	DELETE	LOOK	ERASE CUR

- **OPEN** - writes a program from the internal storage to current memory. First input the part number and then press the OPEN key.
- **SAVE** - writes the program in current memory to the internal storage.
- **DELETE** - erases a program from the internal storage.
- **LOOK** – draws the part for you to preview before opening
- **ERASE CUR** - erases the program from current memory. You do this to clear current memory in order to write a new program.
- **.PT4** –specifies the selected or entered part number as a PT4 file (found under OPEN button)
- **.GCD** - specifies the selected or entered part number as a G Code file (found under OPEN button)
- **SAVE TEMP** – saves the program, part zero, tool table and other set up information in a temporary file. You would use this if you plan to run the same part after powering down the TRAK 2^{OP}. This file can be opened by pressing the OPEN TEMP button on the initial TMX screen upon boot up.

11.4 File Transfer and Backup

2 USB ports are provided and an optional USB flash drive offered as a convenient way to transfer and backup part programs.

If you buy the optional USB flash drive from Southwestern Industries, it will already be configured correctly. If you use your own flash drive, it is possible the control may not contain the driver required to recognize the drive.

11.5 Networking

By default, the ProtoTRAK TMX control is set to look for part programs on the first removable USB flash drive that is available. However, this can be changed to a network location by using service code 345. To access this from the MODE screen, press the RSTR front panel button, followed by SERV CODES soft key, and then type in 345 and press ABS SET.

SERV		SERVO ON	INCH
Code 345 - Set Part Program Location			
Device: usb drive			
Location: usb-disk\2op programs			
NETWORK SHARE			RETURN

This picture shows the default location of where the TMX control will look for part programs. DEVICE shows whether it is currently looking for programs on the USB drive or the network. LOCATION shows the folder that it will open under PROG I/O. Note that on a USB flash drive, only the "2op Programs" folder is able to be accessed. It will also be automatically created when saving programs to the USB drive.

To change from USB storage to a network location, press the NETWORK SHARE softkey. The screen will now give you more options to set up your network. If you wish to go back to opening from / saving to the USB flash drive, then press the USB DRIVE soft key.

SERV		SERVO ON		INCH
Code 345 - Set Part Program Location				
Device: network drive				
Location: \\companyxyz_server1\swi_parts\2op programs				
USB DRIVE	SET PATH	NET INFO		RETURN

Press the SET PATH softkey to manually type in the network path of the shared folder that you want to open files from.

SERV		SERVO ON		INCH																																								
Code 345 - Set Part Program Location																																												
Device:	\\CompanyXYZ_Server1\SWI_Parts\2OP Programs																																											
Location:	<table border="1"> <tr> <td>A</td><td>B</td><td>C</td><td>D</td><td>E</td><td>F</td><td>G</td><td>H</td><td>I</td><td>J</td> </tr> <tr> <td>K</td><td>L</td><td>M</td><td>N</td><td>O</td><td>P</td><td>Q</td><td>R</td><td>S</td><td>T</td> </tr> <tr> <td>U</td><td>V</td><td>W</td><td>X</td><td>Y</td><td>Z</td><td>+</td><td>-</td><td>*</td><td>/</td> </tr> <tr> <td>,</td><td colspan="4">Press SET to enter the highlighted alphabet, or key in any number.</td><td></td><td></td><td></td><td></td><td></td> </tr> </table>				A	B	C	D	E	F	G	H	I	J	K	L	M	N	O	P	Q	R	S	T	U	V	W	X	Y	Z	+	-	*	/	,	Press SET to enter the highlighted alphabet, or key in any number.								
A	B	C	D	E	F	G	H	I	J																																			
K	L	M	N	O	P	Q	R	S	T																																			
U	V	W	X	Y	Z	+	-	*	/																																			
,	Press SET to enter the highlighted alphabet, or key in any number.																																											
CLEAR	BACK SPACE		ENTER	END																																								

The path can be typed in by using the electronic handwheel to scroll through the letters and pressing the ENTER softkey. Use the numeric front panel keys to type in numbers, and then press END when completed. You can also plug in a USB keyboard to type in the path.

Note that you want to make sure that the folder you are accessing is properly being shared so that it is accessible by the ProtoTRAK control.

The NET INFO button can be used to test the path specified, and to help troubleshoot if you find that you are having connectivity issues. When this softkey is used, the ProtoTRAK TMX control will attempt to write a temp file to the defined network location, and then read it back from the same location. It will display the results on the screen.

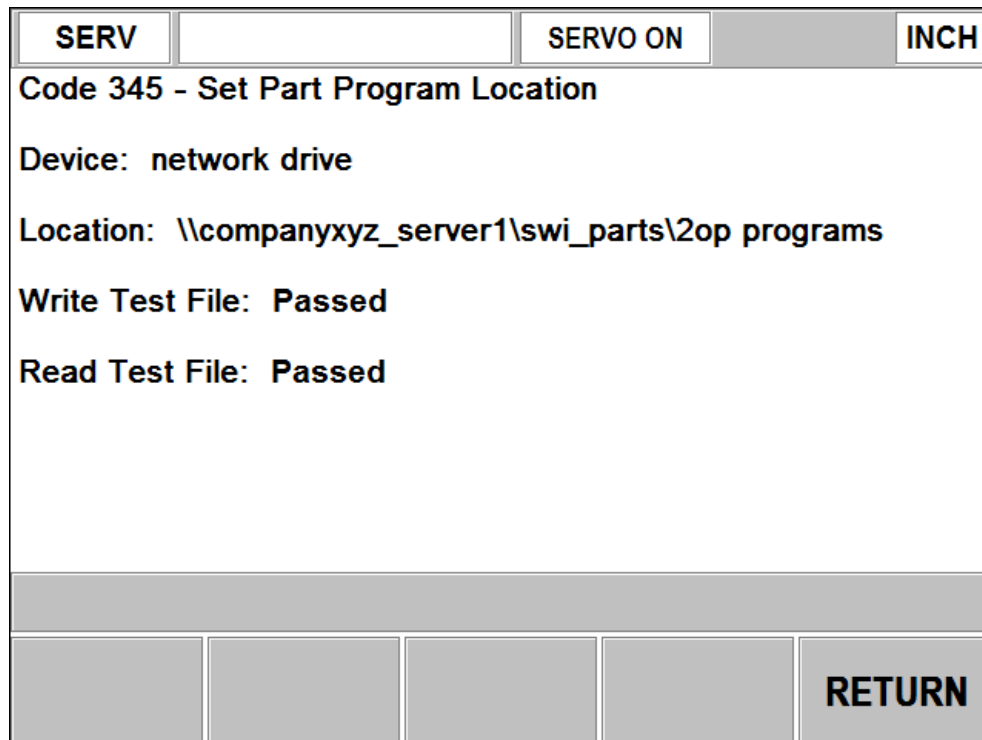

The picture above shows that the control was successfully able to read and write to the specified path.

This next picture shows the result of the same test, except it was not able to properly establish a connection.

SERV		SERVO ON	INCH
Code 345 - Set Part Program Location			
Device: network drive			
Location: \\companyxyz_server1\swi_parts\2op programs			
Write Test File: Failed			
Read Test File: Failed			
Server: Not found and/or cannot resolve server name			
			RETURN

When this is the case, you should double check the following:

- 1) The Location / path specified is correct. Check spelling, case sensitivity, spaces, etc.
- 2) All your physical connections and devices. This includes Ethernet cables, routers, switches, etc.
- 3) Make sure that location specified is properly being shared, and is accessible by this device.

Network Setup

Our ProtoTRAK TMX control only has the ability to open a network path that is openly being shared, without any username / password restrictions. If this is the case, simply connecting your TRAK 2op directly to your PC or to a hub or router that the PC is connected to, should be all that is needed in order for this to work.

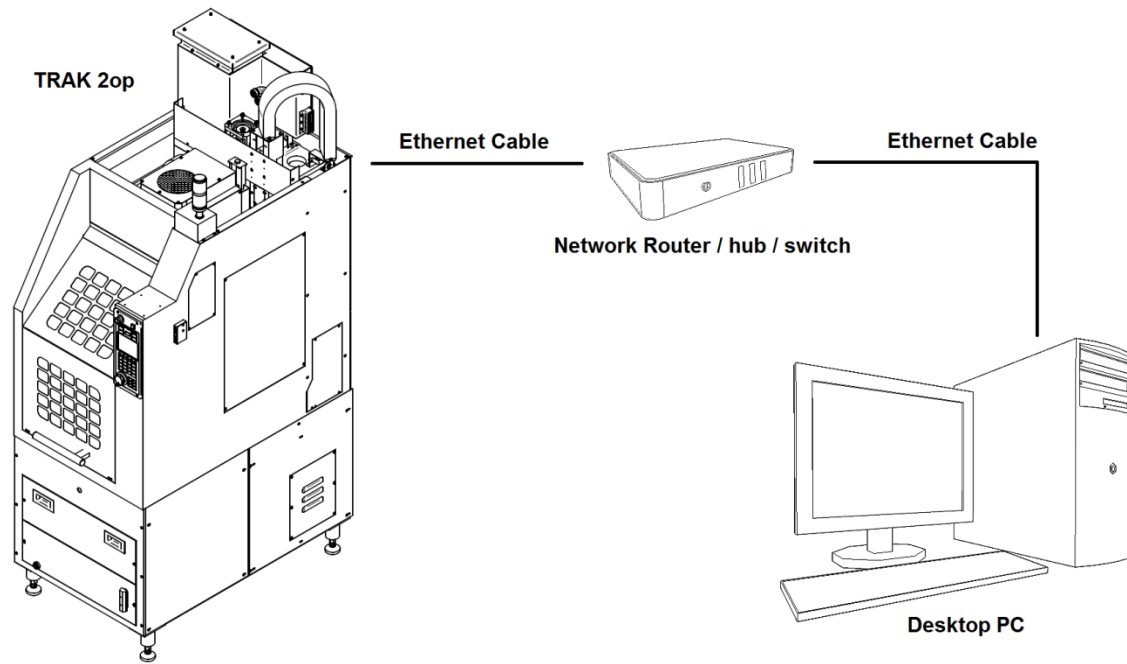

However, if your PC is part of a network where a username and password combination is required, then it is recommended to use a wireless media bridge in order to successfully communicate with your network.

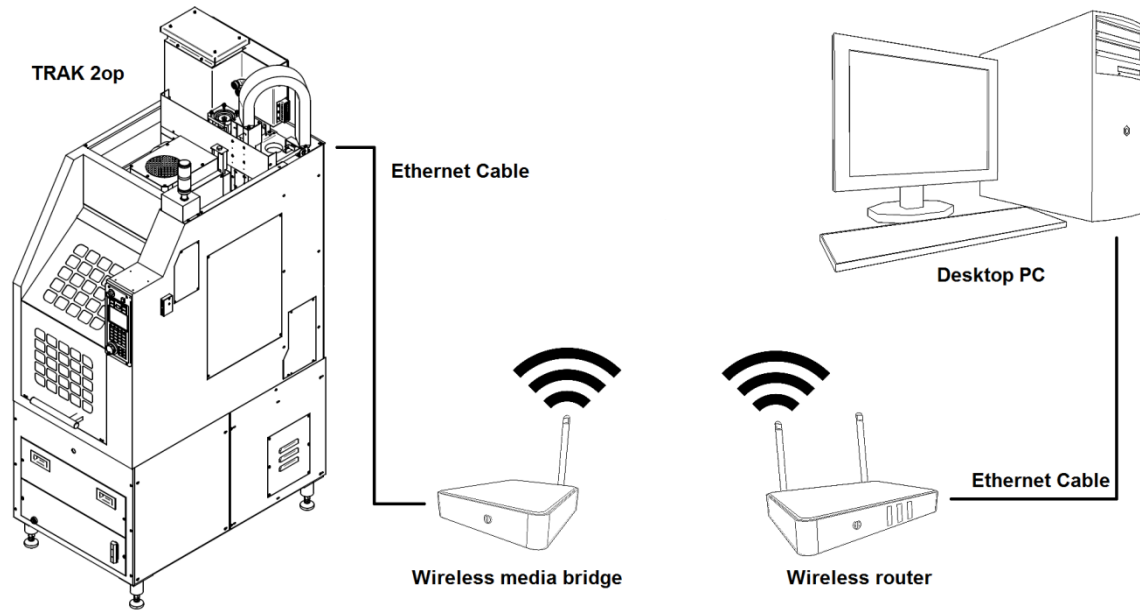

The wireless bridge can be setup to fit the requirements of your network, where you can define a username, password, IP address, workgroup, domain, etc. They are used commonly for devices such as TV's and media players, to accomplish the same task. Instructions on how to do this will vary between models, but they will usually involve hooking it up to a desktop pc first, logging into the device, following the setup procedure, and then connecting it to the device of your choice.

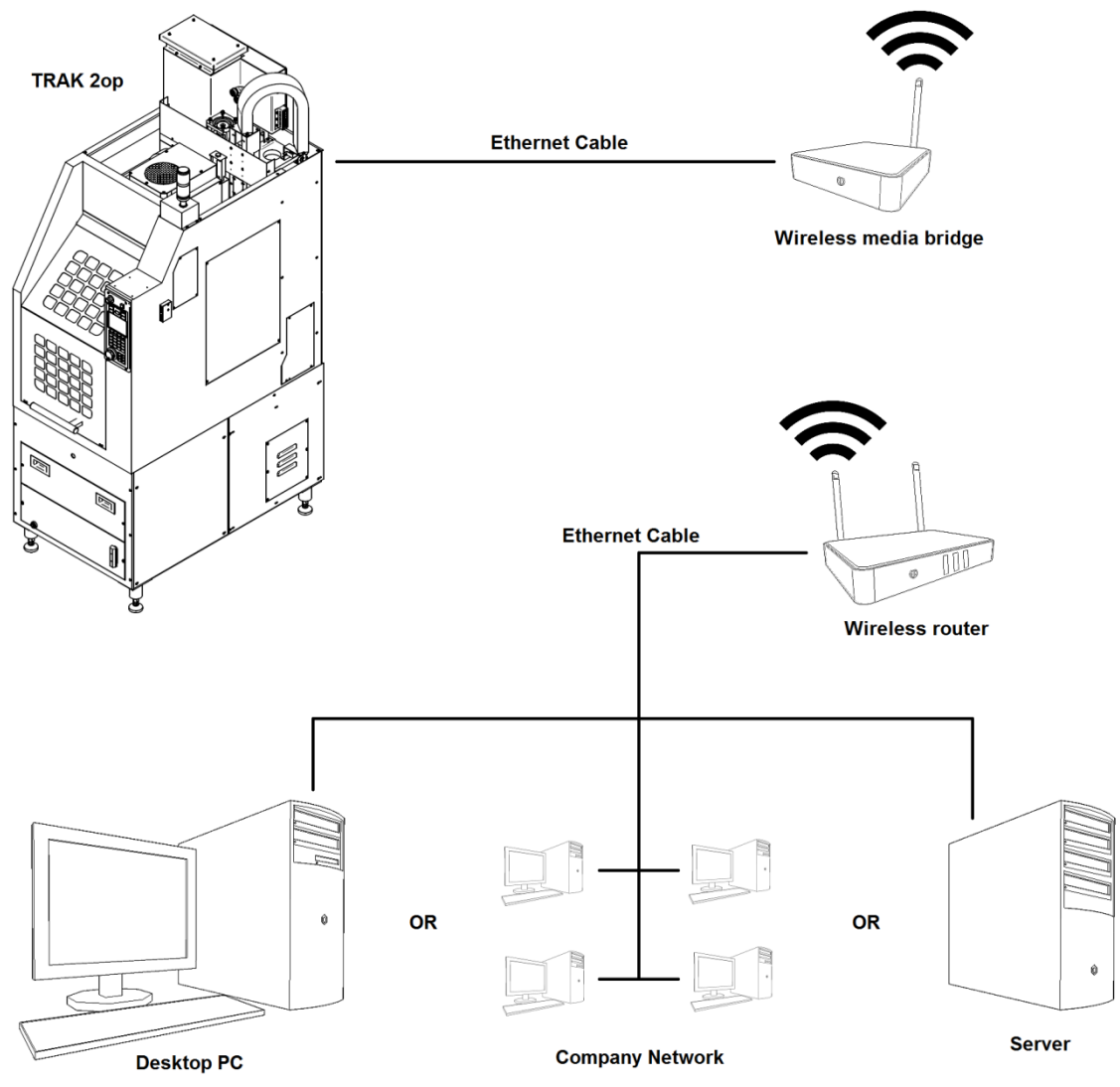

Companies such as Linksys, D-Link, and TRENDnet offer relatively inexpensive media bridges that can accommodate multiple devices.

TRAK Machine Tools
Southwestern Industries, Inc

TRAK Warranty Policy

Warranty

TRAK products are warranted to the original purchaser to be free from defects in workmanship and materials for the following periods:

Product	Warranty Period	
	Materials	Factory Labor
New TRAK/ProtoTRAK	1 Year	1 Year
Any EXCHANGE Unit	90 Days	90 Days

The warranty period starts on the date of the invoice to the original purchaser from Southwestern Industries, Inc. (SWI) or their authorized distributor.

If a product, subsystem or component proves to be defective in workmanship and fails within the warranty period, it will be repaired or exchanged at our option for a properly functioning unit in similar or better condition. Such repairs or exchanges will be made FOB Factory/Los Angeles.

Disclaimers of Warranties

- This warranty is in lieu of any other warranties, express or implied, including any implied warranty of merchantability or fitness for a particular purpose, and of any other obligations or liability on the part of SWI (or any producing entity, if different).
- Warranty repairs/exchanges do not cover incidental costs such as installation, labor, freight, etc.
- SWI is not responsible for consequential damages from use or misuse of any of its products.
- TRAK products are precision mechanical/electromechanical/electronic systems and must be given the reasonable care that these types of products require.
- Proper maintenance and lubrication as directed in the product manual is the responsibility of the customer. This warranty does not apply if the customer does not properly maintain the unit.
- Accidental damage, beyond the control of SWI, is not covered by the warranty. Thus, the warranty does not apply if a product has been abused, dropped, hit or disassembled.
- Improper installation by or at the direction of the customer in such a way that the product consequently fails, is considered to be beyond the control of the manufacturer and outside the scope of the warranty.

F10302 - Rev 62518